

## GUIDANCE OF EFSA

# EFSA Guidance Document on the risk assessment of plant protection products on bees (*Apis mellifera*, *Bombus* spp. and solitary bees)<sup>1</sup>

European Food Safety Authority<sup>2,3</sup>

European Food Safety Authority (EFSA), Parma, Italy

This scientific output, published on 04 July 2014, replaces the earlier version published on 4 July 2013\*

### ABSTRACT

The Guidance Document is intended to provide guidance for notifiers and authorities in the context of the review of plant protection products (PPPs) and their active substances under Regulation (EC) 1107/2009. The scientific opinion on the science behind the development of a risk assessment of plant protection products on bees (*Apis mellifera*, *Bombus* spp. and solitary bees) (EFSA Panel on Plant Protection Products and their Residues (PPR), 2012a) provided the scientific basis for the development of the Guidance Document. Specific Protection Goals were agreed in consultation with the Standing Committee on the Food Chain and Animal Health. The Guidance Document suggests a tiered risk assessment scheme with a simple and cost-effective first tier to more complex higher tier studies under field conditions. Each of the tiers will have to ensure that the appropriate level of protection is achieved.

© European Food Safety Authority, 2013

### KEY WORDS

honey bees, risk assessment, Guidance Document, pesticides, *Apis mellifera*, *Bombus* spp., solitary bees

---

<sup>1</sup> On request from European Commission, Question No EFSA-Q-2011-00418, approved on 27 June 2013.

<sup>2</sup> Correspondence: pesticides.ppr@efsa.europa.eu

<sup>3</sup> Acknowledgement: EFSA wishes to thank the members of the working group: Gérard Arnold, Jos Boesten, Mark Clook, Robert Luttik, Fabio Sgolastra, Jacoba Wassenberg and the hearing expert Jens Pistorius for the preparatory work on this scientific output and EFSA staff: Franz Streissl, Maria Arena, Csaba Szentes, Agnès Rortais and Olaf Mosbach-Schulz for their support. EFSA would also like to thank the Member States experts Rosie Oates, Jens Pistorius, Veronique Poulsen, Dirk Süßenbach and Emily McVey for their support to restructure the EFSA Guidance Document.

\* The structure of this Guidance Document has been revised to enhance its usability following feedback from risk managers; in particular the entire risk assessment procedure is now summarised in chapter 3. In addition, two calculator tools have been appended and hyperlinks to key information have been added. The revision also included minor editorial amendments that do not materially affect the contents of the document. To avoid any confusion and to ensure that the most current version of the document is used, the original version has been removed from the EFSA Journal but is available on request.

Suggested citation: European Food Safety Authority, 2013. EFSA Guidance Document on the risk assessment of plant protection products on bees (*Apis mellifera*, *Bombus* spp. and solitary bees). EFSA Journal 2013;11(7):3295, 268 pp., doi:10.2903/j.efsa.2013.3295

Available online: [www.efsa.europa.eu/efsajournal](http://www.efsa.europa.eu/efsajournal)

## SUMMARY

The European Food Safety Authority (EFSA) was asked by the European Commission (EC) to develop a Guidance Document on the risk assessment of plant protection products on bees. The Guidance Document is intended to provide guidance for notifiers and authorities in the context of the review of plant protection products (PPPs) and their active substances under Regulation (EC) 1107/2009. The scientific opinion on the science behind the development of a risk assessment of plant protection products on bees (*Apis mellifera*, *Bombus* spp. and solitary bees) (EFSA Panel on Plant Protection Products and their Residues (PPR), 2012a) provided the scientific basis for the development of the Guidance Document.

The process of the development of the Guidance Document follows the methodology of definition of specific protection goals (SPGs) as outlined in the scientific opinion of EFSA's Plant Protection Products and their Residues Panel (EFSA Panel on Plant Protection Products and their Residues (PPR), 2010). The Standing Committee on the Food Chain and Animal Health was consulted for the appropriate levels of protection (e.g. to make choices on the magnitude of effects, duration of effects and exposure percentiles).

The Guidance Document suggests the implementation of a tiered risk assessment scheme with a simple and cost-effective first tier to more complex higher tier studies under field conditions. Each of the tiers will have to ensure that the appropriate level of protection is achieved.

More detailed guidance on specific aspects of laboratory studies and higher tier risk assessments is given in the appendices. A need for test protocols for bumble bees and solitary bees was identified. Potential protocols are available in the published literature and first proposals are made in the appendices. It is important that fully validated test protocols are developed in future.

## TABLE OF CONTENTS

Abstract .....	1
Summary .....	2
Table of contents .....	3
Background as provided by the European Commission.....	6
Terms of reference as provided by the European Commission.....	6
Context of the scientific output .....	6
1. Introduction .....	8
2. Protection goals as agreed with risk managers from Member States.....	12
3. Risk assessment schemes .....	13
3.1. Introduction.....	13
3.2. Risk assessment schemes for spray applications .....	16
3.2.1. Contact exposure assessment for spray applications .....	17
3.2.2. Oral exposure assessment for spray applications .....	18
3.3. Risk assessment schemes for solid formulations .....	26
3.3.1. Contact exposure assessment for solid formulations.....	26
3.3.2. Oral exposure assessment for solid applications .....	29
3.4. Risk assessment for accumulative effects.....	41
3.5. Assessment of risk from exposure to contaminated water.....	41
3.5.1. Assessment of risk from exposure to guttation water.....	41
3.5.2. Assessment of risk from exposure to surface water .....	47
3.5.3. Assessment of risk from exposure to water in puddles .....	48
3.6. Risk assessment scheme for metabolites .....	49
3.6.1. Alternative information replacing experimental studies.....	51
3.6.2. Toxicity testing with metabolites .....	51
3.6.3. Refined risk assessment for metabolites.....	51
3.7. Higher tier risk assessment .....	52
3.8. Assessment of uncertainty and finalisation of the risk assessment.....	53
4. Uncertainty analysis.....	54
4.1. Approaches for characterising uncertainty in higher tier assessments.....	54
4.2. Risk characterisation and weight-of-evidence assessment .....	56
5. Exposure assessment for bees resulting from consumption of nectar and pollen and assessment of contact exposure .....	60
5.1. Exposure assessment for consumption of nectar and pollen entering the hive.....	60
5.1.1. Specification of the exposure assessment goal.....	60
5.1.2. Relationship between the exposure assessments of honey bees, bumble bees and solitary bees .....	60
5.1.3. Selection of the ecotoxicologically relevant type of concentration.....	61
5.1.4. Principles of linking of exposure and effect assessment .....	61
5.1.5. The need for an exposure assessment at landscape level.....	63
5.1.6. The hierarchy of the exposure assessment.....	63
5.1.7. Overview of the exposure assessment for spray applications.....	64
5.1.8. Overview of the exposure assessment for solids .....	66
5.2. Exposure and risk assessment resulting from contact exposure .....	67
5.2.1. Exposure assessment goal and combination with effect assessment.....	67
5.2.2. HQ approach.....	68
5.3. Spray applications.....	69
5.3.1. Introduction .....	69
5.3.2. The treated crop.....	69
5.3.3. Weeds in the treated field .....	70
5.3.4. Plants in field margins .....	71
5.3.5. Adjacent crops .....	72
5.4. Seed treatments .....	73
5.4.1. Introduction .....	73

5.4.2.	The treated crop .....	73
5.4.3.	Weeds in the treated field .....	73
5.4.4.	Plants in field margins .....	73
5.4.5.	Adjacent crops .....	74
5.5.	Granules .....	75
5.5.1.	Introduction .....	75
5.5.2.	The treated crop .....	75
5.5.3.	Weeds in treated field .....	76
5.5.4.	Field margins .....	76
5.5.5.	Adjacent crop .....	77
6.	Effects assessment .....	78
6.1.	Honey bee effects studies .....	78
6.1.1.	Laboratory studies .....	78
6.1.2.	Semi-field and field studies .....	79
6.2.	Bumble bees effects studies .....	79
6.2.1.	Lower tier studies .....	79
6.2.2.	Higher tier studies .....	80
6.3.	Solitary bees effects studies .....	81
6.3.1.	Lower tier studies .....	81
6.3.2.	Higher tier studies .....	82
7.	Trigger values .....	84
8.	Mixture toxicity and toxicity of formulated products with two or more active substances .....	87
9.	Risk mitigation options .....	89
9.1.	Risk mitigation for bees .....	89
9.1.1.	Important factors to consider when developing risk mitigation measures .....	90
9.1.2.	Definitions that may be useful in determining when risk mitigation can be used .....	90
9.1.3.	Possible risk mitigation measures and associated phrases .....	90
9.1.4.	Mitigating the risk from spray applications .....	91
9.1.5.	Mitigating the risk from solid applications .....	93
10.	Sublethal effects .....	95
Appendices	.....	97
Appendix A.	Nomenclature for effect sizes .....	98
Appendix B.	Protection goals .....	101
Appendix C.	Relevance of dust for treated seeds .....	103
Appendix D.	Attractiveness of agricultural crops to honey bees and bumble bees for the collection of nectar and/or pollen .....	107
Appendix E.	Landscape-level exposure assessment of the average concentration entering the hive .....	122
Appendix F.	Pesticide residue levels in nectar and pollen and the residue unit doses (RUDs) .....	125
Appendix G.	Protocol for performing field studies for higher exposure tiers .....	134
Appendix H.	Assessment of spray drift and dust drift deposition onto field margins and adjacent fields .....	137
Appendix I.	Assessment of the percentile of a subpopulation that corresponds to a prescribed percentile of the total population .....	144
Appendix J.	Shortcut values for the estimation of the oral exposure via nectar and pollen consumption .....	146
Appendix K.	Literature review on daily mortality rate .....	156
Appendix L.	Use of HQ and ETR approach for solid formulations .....	164
Appendix M.	Trigger values .....	165
Appendix N.	Exposure assessment for bees for nectar and pollen entering the hive .....	176
Appendix O.	Effects studies—protocols, guidance and guidelines for honey bee, bumble bee and solitary bee .....	202
Appendix P.	Test protocols for bumble bees ( <i>Bombus terrestris</i> ) .....	226
Appendix Q.	Test protocols solitary bees ( <i>Osmia cornuta</i> and <i>Osmia bicornis</i> = <i>O. rufa</i> ) .....	230
Appendix R.	Test crops to be used .....	236
Appendix S.	Refinement option for crop specific nectar and pollen consumption .....	237

Appendix T.	Background to the exposure estimates and trigger values used in the risk assessment for guttation .....	239
Appendix U.	Test protocols to assess the effects of pesticides in guttation on honey bees .....	242
Appendix V.	Assessment of uncertainty .....	243
Appendix W.	Illustrative scheme for assessment of sublethal effects .....	248
Appendix X.	Inventory of exposure factors (Ef) to be used in the risk assessment schemes for the estimation of the oral route exposure.....	253
Appendix Y.	EFSA Screening step and 1 <sup>st</sup> tier calculator bee risk assessment .....	257
Appendix Z.	EFSA Monte Carlo calculator tool for exposure refinement.....	257
Glossary and abbreviations .....		258
References .....		260

## BACKGROUND AS PROVIDED BY THE EUROPEAN COMMISSION

EFSA is currently revising the European Guidance Document on terrestrial ecotoxicology elaborated by the Commission and experts from Member States. In the context of this revision, the bees risk assessment will also be addressed.

Members of the European Parliament and beekeepers' associations have expressed their concerns to the Commission as to the appropriateness of the current risk assessment scheme, and in particular on the EPPO<sup>4</sup> "Environmental risk assessment scheme for Plant Protection Products —chapter 10: honey bees" (EPPO/OEPP, 2010) revised in September 2010 with ICPBR<sup>5</sup> recommendations.

Considering the importance and the sensitiveness of this issue, and in line with the aim of the Commission Communication on Honey bee Health (COM (2010) 714 final)<sup>6</sup> adopted on 6 December 2010, the Commission considers that the revised EPPO assessment scheme would need further consideration by EFSA in an Opinion on the science behind the risk assessment for bees and that a Guidance Document on the risk assessment of Plant Protection Products on bees should be developed.

## TERMS OF REFERENCE AS PROVIDED BY THE EUROPEAN COMMISSION

A scientific Opinion of the PPR Panel on the science behind the development of a risk assessment of Plant Protection Products on bees (*Apis mellifera*, *Bombus spp.* and solitary bees) will be prepared.

In particular the following issues will be addressed:

- The assessment of the acute and chronic effects of Plant Protection Products on bees, including the colony survival and development.
- The estimation of the long-term effects due to exposure to low concentrations
- The development of a methodology to take into account cumulative and synergistic effects.
- The evaluation of the existing validated test protocols and the possible need to develop new protocols, especially to take into account the exposure of bees to pesticides through nectar and pollen.

In order to have the possibility for stakeholders and the interested public to comment on the draft Guidance Document, we propose to include a round of public consultations on the draft Guidance Document. An Opinion on the science behind the Guidance Document could be delivered by April 2012 and a final Guidance Document in December 2012.

## CONTEXT OF THE SCIENTIFIC OUTPUT

The Guidance Document is intended to provide guidance for notifiers and authorities in the context of the review of Plant Protection Products (PPPs) and their active substances under Regulation (EC) 1107/2009.

The scientific Opinion on the science behind the development of a risk assessment of Plant Protection Products on bees (*Apis mellifera*, *Bombus spp.* and solitary bees) (EFSA Panel on Plant Protection Products and their Residues (PPR), 2012a) provided the scientific basis for the development of the Guidance Document.

---

<sup>4</sup> European and Mediterranean Plant Protection Organization.

<sup>5</sup> International Commission for Plant-Bee Relationships Statutes.

<sup>6</sup> Communication from the Commission to the European Parliament and the Council on Honeybee Health, COM(2010) 714 final, adopted on 06/12/2010.

A public consultation was conducted in order to give stakeholders and the interested public the opportunity to comment on the draft Guidance Document.

## 1. Introduction

A decline in some pollinator species has been reported in several different regions of the world (Biesmeijer et al., 2006; Committee on the Status of Pollinators in North America, 2007). The causes of these declines have received much attention from regulatory authorities. In addition, incidents where bees have been poisoned have been reported in Europe (e.g. exposure to dust from seed treatments). Therefore, as pollination is an important ecosystem service for food production and maintenance of biodiversity (Gallai et al., 2009), much research and monitoring of honey bee colony losses and bee poisoning incidents, as well as research with other pollinators, has been carried out.

Pesticides have often been considered as one of the factors contributing to the decline of some insect pollinator species. Concerns have been raised by Members of the European Parliament and beekeepers' associations on the appropriateness of the current risk assessment schemes for plant protection products. The European Commission tasked the EFSA with issuing an opinion on the science behind the risk assessment for bees and to develop a Guidance Document on the risk assessment of plant protection products on bees (*Apis mellifera*, *Bombus* spp. and solitary bees). The Opinion on the science behind the risk assessment which was published in May 2012 (EFSA Panel on Plant Protection Products and their Residues (PPR), 2012a) provides the basis for the current Guidance Document.

The process of the development of the Guidance Document follows the methodology of definition of specific protection goals (SPGs) as outlined in the scientific opinion of EFSA's PPR Panel (EFSA Panel on Plant Protection Products and their Residues (PPR), 2010). As risk management choices need to be made to define the SPGs, the Standing Committee on the Food Chain and Animal Health (SCoFAH) was consulted for the appropriate levels of protection (e.g. to make choices on the magnitude of effects, duration of effects and exposure percentiles).

The objective of this Guidance Document (GD) is to outline a process by which plant protection products (PPPs) can be evaluated for their potential risk in causing unacceptable harm to a group of non-target organisms (bees). The maximum acceptable level of harm is defined by SPGs, which are set out in the GD.

In practice, the process for risk assessment has two main components: a preliminary exposure assessment (EA) that yields the predicted environmental concentration (PEC) of the PPP that the bees are exposed to in a severe case; and an effect assessment that compares the degree of harm that can result from exposure of bees to the PEC against the maximum level given by the SPGs. For example, a PPP that was unlikely to come into any contact with bees during agricultural use would have a PEC of zero and the effect assessment component of the risk assessment process would be unnecessary.

This GD proposes the use of a tiered risk assessment scheme with a simple and cost-effective first tier to more complex higher tier studies under semi-field and field conditions. Each of the tiers will have to ensure that the appropriate level of protection is achieved.

The first tier is intended to sift out PPPs that are of negligible risk to bees and so prevent unnecessary further testing. This first tier involves various triggers that are typically calculations based on the PEC and the known toxicity of the PPP. If the first tier assessment indicates that the SPGs may not be met, then the assessment should be refined by including improved information and/or mitigation measures. Additional information on the potential exposure and/or effects of a pesticide may be used to refine the risk assessment.

The first tier triggers are based on comparing a hazard quotient (HQ) or exposure toxicity ratio (ETR) against a threshold trigger value. The HQ or ETR is the ratio of the PEC to a standard index of the PPP's toxicity to bees (e.g. the LD<sub>50</sub>). A new contribution of this GD is to produce bespoke trigger values that reflect the SPGs.

The higher tier tests were also formulated to reflect the SPGs. Thus, while there are many kinds of observations that would indicate harm to bees at some level, the semi-field and field tests presented here are designed to identify only unacceptable harm of the kind defined in the SPGs.

The working group has considered all the factors in the risk assessment. Table 1 gives a qualitative indication of the level of conservatism in the risk assessment scheme.

**Table 1:** Level of conservatism in the risk assessment scheme

Factor	Level of conservatism: high = +, low = -	How does this impact on the level of conservatism/precaution?
Trigger values are based on the lowest background mortality rates which were found in literature	+	The specific protection goals and associated trigger values are based on the lowest background mortality levels found in the literature. It is possible that colonies could withstand a larger increase in mortality with no adverse effects. The selected level of mortality is potentially worst case and hence protective.
The lowest sugar content is used in the initial steps of the risk assessment	+	The lowest sugar content in nectar which is attractive to bees as a food source was used to calculate the exposure. This gives a high uptake rate and hence makes the exposure estimate conservative in the initial steps. This factor can be refined relatively easily in higher tier assessments.
Use of stores within the colony	+	The risk assessment for consumption of nectar and pollen in the hive is based on the maximum in time of the concentration of the residues entering the hive. This is a conservative approach so it is expected that this leads to an overestimation of the true daily intake of the substance in the hive.
Exposure of colonies under field conditions	+	The risk assessment considers colonies which are placed next to the treated field and hence this potentially maximises the amount of nectar and pollen which is collected from the treated field and brought back to the hive.
Scheme is field based not landscape based	+/(−)	<p>The real risk to honey bees colonies at the edge of fields will potentially be less than that predicted due to the role of dilution, i.e. the residues entering the colony will be less than those modelled.</p> <p>The risk assessment ignores dilution of residues in the colony that could occur due to wide foraging range of honey bees. On the one hand this is likely to lead to a protective risk assessment as in reality dilution will occur and hence be less than that used in the risk assessments. However, in very intensive agricultural areas the total area of treated crops will be larger and fewer alternative nectar and pollen sources will be available. The duration of flowering could be prolonged (other fields may flower with some delays) which would also prolong the duration of exposure. Overall the level of dilution of residues will become small under such circumstances.</p>

An assessment factor of 5 is included in the trigger values for honey bee larvae to account for potential differences in sensitivity of subspecies of honey bees and extrapolation from lab to field effects	+/-	The assessment factor of 5 is arbitrary and is aimed at accounting for intra-species variability and extrapolating from laboratory to field. Justification has been provided; however, it is uncertain whether this is over- or underprotective.
Initial residue per unit dose data used in the initial tiers of the risk assessment were collected via a range of methodologies	+/-	It is likely that the method of collection could affect the residue detected, for example whether the residue detected in pollen would be the same regardless of whether it was collected directly from the flower, from the bee or from pollen traps. It is not known whether this results in either an under- or overestimate in residues.
Factor of 3 for extrapolating from spray drift exposure to dust drift exposure	+/-	An arbitrary factor of 3 has been proposed when extrapolating from spray drift to dust drift in the initial steps of the risk assessment.  It is uncertain whether this is over- or underprotective.
Exposure of foragers under field conditions when the nectar source is next to the colony (colony at the edge of the treated field)	+/-	The energy requirement for a bee foraging the whole day is dependent not so much on the distance to the nectar source as on the overall time spent flying. The flying time of a forager bee for the whole day will be similar regardless whether it needs to forage at a large distance or in a field close by. However, the exposure of bees which fly longer distances may be higher because they will directly consume the freshly collected nectar with high residues while bees with short foraging flights consume nectar stored in the hive, which could be diluted with uncontaminated nectar. However, if foragers were to die quickly from such an exposure or to be unable to return to the hive, then they would not be able to communicate to the other bees the position of the nectar source. As a consequence, less forager would fly to that field and also less contaminated nectar and pollen would be brought back to the hive.
Scheme is field based not landscape based	-	No account is taken of exposure to multiple products.
Health status of honey bees	-	Healthy colonies are used whereas in reality colonies will be subjected to a range of disease and pest pressure (as well as associated treatments). This factor is not taken in to account.
Assessment of the sublethal effects	-	Sublethal effects observed in individual bees have the potential to affect the development and the survival of the colonies. However, it is not possible with the information available to the working group to make a quantitative link between sublethal effects observed in first tier laboratory studies and effects on colonies. This could underestimate the risk in lower tiers.
Exposure from residues in wax	-	Exposure in wax is not currently considered in the risk assessment scheme. This could underestimate the risk for certain types of compounds.
Exposure via honey dew	-	Exposure via honey dew was not included in the risk assessment scheme because of high uncertainty around this exposure route.

It was not possible to suggest a robust risk assessment scheme for exposure to honey dew because of high uncertainty around this exposure route. It was unclear under which circumstances exposure via honey dew will occur, the amount of residues which will be found in honey dew and how exposure to honey dew should be tested in higher tiers. Such a scheme may be developed in future if sufficient data become available to address these issues.

The above table covers honey bees; however, the risk assessment scheme also covers bumble bees and solitary bees. The following points are relevant to bumble bees and solitary bees and are in addition to those outlined above.

1. Bumble bees and many solitary bees make nests in the soil or use mud as nesting material. However, exposure by residues in the soil is not currently considered in the risk assessment scheme because it was not possible to link the concentration in the soil to the effects on bees.
2. An additional assessment factor of 5 is proposed for bumble bees to account for their potential greater sensitivity to reproductive effects due to forager losses. This assessment factor is arbitrary and hence this could over- or underestimate the real risk. An additional assessment factor of 5 is proposed for solitary bees to account for differences in sensitivity of different species. This assessment factor could over- or underestimate the real risk.
3. An assessment factor of 10 is proposed to extrapolate from honey bee endpoints to endpoints for bumble bees and solitary bees. In 95% of the cases the difference in sensitivity of species were less than a factor of 10 and hence is considered appropriate to be used in a first tier assessment.

The conservatism of the first tier assessment could be lowered in future without changing the level of protection if data become available which would allow refining the current trigger values and the assessment factors in the exposure estimates.

## 2. Protection goals as agreed with risk managers from Member States

Specific protection goals (SPGs) based on ecosystem services were defined according to the methodology outlined in the scientific opinion of the EFSA Panel on Plant Protection Products and their Residues (PPR) (2010). In consultation with risk managers in the SCoFCAH (Standing Committee on the Food Chain and Animal Health) the SPGs for honey bees were set as follows.

The attributes to protect were defined as survival and development of colonies and effects on larvae and bee behaviour as listed in regulation (EC) No 1107/2009.<sup>7</sup> In addition, abundance/biomass and reproduction were also included because of their importance for the development and long-term survival of colonies.

The viability of each colony, the pollination services it provides, and its yield of hive products all depend on the colony's strength and, in particular, on the number of individuals it contains. It is therefore proposed to relate protection goals specifically to colony strength, which is defined operationally as the number of bees it contains (= colony size).

The magnitude of effects on colonies should not exceed 7% reduction in colony size. Foragers mortality should not be increased compared with controls by a factor of 1.5 for six days or a factor of 2 for three days or a factor of 3 for two days.

Honey production is important for beekeepers and should therefore be included in the SPGs. It is likely that honey production is covered by the above-mentioned protection goals for colony development and forager mortality. In consultation with risk managers it was decided not to include honey production as an obligatory measurement endpoint in field studies. However, honey production could be included in the field study reports if the results of the methods of assessing forager mortality and colony strength are not sufficient.

The EFSA Panel on Plant Protection Products and their Residues (PPR) (2012a) proposed SPGs for bumble bees and solitary bees. Data on mortality rates of bumble bees and solitary bees are scarce and it was not possible to give clear definitions for the magnitude of effects based on background mortality and thresholds of effects on populations of solitary bees. According to Thompson and Hunt (1999) and Thompson (2001) it is not possible to read across from honey bees to bumble bees and solitary bees. This lack of read across is due to a combination of sensitivity to the PPP and ecology (i.e. their feeding and breeding behaviour). It may be that some non-*Apis* bees are of lower sensitivity to PPPs than honey bees, but their ecology is sufficiently different such that the PPP poses a different and potentially greater risk. The analysis of factors that could increase or decrease the risk in bumble bees and solitary bees compared with honey bees showed that bumble bees and solitary bees are potentially more vulnerable than honey bees. As a pragmatic solution, effect percentages as for honey bees are suggested in combination with an additional safety factor to account for differences in vulnerability.

The overall level of protection also includes the exposure assessment goals. It was decided that the exposure assessment should be done for each of the regulatory zones. By defining a certain percentile exposure assessment goal (e.g. 90th ) it means that 90% of all colonies at the edge of a treated field in one regulatory zone should be exposed to a lower quantity than what is assessed in the risk assessment.

For further details on setting of protection goals see [Appendix A](#) and [Appendix B](#).

---

<sup>7</sup> Regulation (EC) No 1107/2009 of the European Parliament and of the Council of 21 October 2009 concerning the placing of plant protection products on the market and repealing Council Directives 79/117/EEC and 91/414/EEC.

### 3. Risk assessment schemes

#### 3.1. Introduction

The previous risk assessment for honey bees (EC (2002b))<sup>8</sup> was based on the toxicity of the active substance and/or PPP to worker honey bees. The toxicity endpoints were determined by conducting LD<sub>50</sub> (contact) and LD<sub>50</sub> (oral) laboratory tests (EPPO, 2003); (OECD 213, 1998) (OECD 214, 1998). It is recognised that this approach did not take into account the potential chronic or repeat exposure to adult bees nor did it consider the potential risk to larvae (except for insect growth regulators). In addition, it is acknowledged that the previous approach did not cover the potential exposure and hence risk to bumble bees or solitary bees, see EFSA Panel on Plant Protection Products and their Residues (PPR) (2012a) for further details).

The risk assessment to bumble bees and solitary bees from the use of pesticides has not been routinely carried out. Therefore, what is presented below is a proposal as to how the risk can be determined. Owing to a lack of standardised toxicity studies and information on the inter-species sensitivity of bumble bees, there is uncertainty in the scheme (see introduction in [chapter 1](#)). Trigger values have been determined and the rationale behind these is provided in [chapter 7](#).

In producing the risk assessment schemes for bumble bees and solitary bees, use has been made of the information from the honey bee scheme. It is acknowledged that extrapolation from honey bees to bumble bees and solitary bees is not straightforward; however, it is considered that the use of data on honey bees and associated trigger values is appropriate in terms of conservatism (see chapters 1, 2 and 9) as well as ensuring that testing is focused on those uses and compounds considered to pose the greatest risk to bumble bees and solitary bees.

In order to determine whether a specific use poses a risk to bees, it is necessary to carry out a detailed risk assessment. The risk assessment presented below considers the following routes of exposure:

- **exposure via contact** from:
  - spray deposits (i.e. overspray or spray drift) or from dust particles
 when bees are either foraging the treated crop, weeds in the field, plants in field margin and the adjacent crop;
  - 3.2.1. [for spray applications](#)
  - 3.3.1 [for seed treatments and granules](#)
- **consumption of pollen and nectar** from:
  - the treated crop,
  - weeds in the field,
  - plants in field margin,
  - the adjacent crop
  - succeeding crop/permanent crop the following year;
  - 3.2.2 [for spray applications](#),
  - 3.3.2 [for seed treatments and granules](#)
- **assessment of accumulative toxicity**
  - 3.4. [Risk assessment for accumulative toxicity](#)

<sup>8</sup> SANCO/10329/2002 rev 2 final Draft Working Document Guidance Document on terrestrial Ecotoxicology Under Council Directive 91/414/EEC.

- **consumption of contaminated water**
  - 3.5.1. [Assessment of risk from exposure to guttation water](#),
  - 3.5.2. [Assessment of risk from exposure to surface water](#),
  - 3.5.3. [Assessment of risk from exposure to water in puddles](#)
- **risk from metabolites present in pollen and nectar.**
  - 3.6. [Risk assessment scheme for metabolites](#)

Further details regarding all these routes of exposure are outlined in [chapter 5](#) and the associated [Appendix N](#).

It should be noted that not all routes are relevant for all uses. However, the assessment still needs to consider all routes and determine whether the route is relevant for the particular use under consideration.

In order to determine the potential risk, the following effects data are required:

- acute contact toxicity to adults, expressed as  $\mu\text{g}/\text{bee}$  ( $\text{LD}_{50}$ );
- acute oral toxicity to adults, expressed as  $\mu\text{g}/\text{bee}$  ( $\text{LD}_{50}$ );
- chronic oral toxicity to adults (including an assessment of the effects on the hypopharyngeal glands (HPGs)), expressed as  $\mu\text{g}/\text{bee}$  per day (10-d  $\text{LD}_{50}$  and NOEL for HPGs);
- toxicity to larvae, expressed as  $\mu\text{g}/\text{larvae}$  per development period<sup>9</sup> (NOEL);
- consideration of the potential accumulative effects.

Please see [Appendix O](#) for details on how to carry out toxicity studies. See [chapter 3.6](#) for information on when studies with metabolites are required.

As regards whether studies on the active substance or the formulation are required, the following is proposed:

Application method	Study with active substance required	Study with formulation required
<i>Spray</i>		
Acute oral	Yes —always required	Yes <sup>a</sup>
Acute contact	If exposure to spray deposits are likely then required	If exposure to spray deposits are likely then required <sup>a</sup>
Chronic oral toxicity to adults	Yes	No <sup>b</sup>
Toxicity to larvae	Yes	No <sup>b</sup>
<i>Solid</i>		
Acute oral	Yes	No <sup>c</sup>
Acute contact	If exposure to spray deposits are likely then required	No <sup>c</sup>
Chronic oral toxicity to adults	Yes	No <sup>c</sup>
Toxicity to larvae	Yes	No <sup>c</sup>

a Acute studies with the formulation are only required if the toxicity cannot be predicted on the basis of the active substance.

<sup>9</sup> Please note that the risk assessment schemes consider the oral exposure of the larvae over the entire developmental period while the larvae are feeding. Therefore, the toxicological endpoint needs to be expressed as the sum of the mass of the residue consumed by a larva during the entire testing period.

- b Generally, a study with the active substance will be sufficient; however, if there is an indication from the acute oral study that the formulation is more toxic than the active substance, then the formulation should be tested. In determining whether there is a difference then the endpoints should be expressed in terms of active substance. If the formulation endpoint is more toxic by at least a factor of 5<sup>10</sup>, then it can be assumed that the formulation is of greater toxicity and hence testing should be carried out using the formulation. If the difference is less than a factor of 5, then the adult chronic toxicity and larval study should only be carried out on the active substance. If endpoints are available from both, active substance and formulation studies then the lower endpoint should be used in the risk assessment.
- c No formulation testing is required for applications applied as solids as the carrier is usually an inert substance or of low toxicity compared with the active substance. If a second active substance is present, this could be addressed by calculating the endpoint based on recommendations in chapter 10. If there is indication of synergistic effects then the formulation should be tested.

The risk assessment scheme for pollen and nectar uses shortcut values (SVs) that are simple to use in that they require an application rate to generate an exposure value. The SV for oral consumption is based on sugar content, food consumption and default Residue per Unit Dose (RUD) figures. The assumptions behind the first tier SVs are explained in Appendix J. The SV is aimed at being protective.

In order to carry out a risk assessment, the risk assessor needs to determine if exposure will occur. If no exposure is considered likely, then no further action is required. However, before reaching this conclusion, there needs to be a detailed consideration of **all** the possible routes of exposure as well as the uncertainty associated with this assessment. If exposure is considered likely, then the risk assessor needs to carry out a risk assessment as outlined below and determine the risk. Depending upon the outcome, further exposure and/or effects data may be required. Risk mitigation measures (see chapter 9) may also be required. Once the assessment is complete, the risk assessor needs to carry out an assessment of the underlying uncertainty (see [chapter 4](#)).

The scheme presented below starts with a screening step which, if failed, is followed by a first tier assessment. If trigger values are breached in the latter then there is a need to consider risk mitigation measures, refined exposure assessments and/or higher tier effects studies. The scheme presented below covers only the screening step and the first tier assessment. There are a number of reasons for not providing a scheme for higher tier assessment if concerns are raised at the first tier:

1. The screening step and first tier consists of a number of tests that have to be carried out for each active substance/metabolite or formulation. Therefore, there are different outcomes possible when running the screening step and first tier and each outcome has to be treated separately. For instance, the higher tier approach could be substantially different if refinement is triggered only by the acute contact risk assessment (i.e. HQcontact), or if the higher tier is triggered by the risk to larvae (i.e. ETRLarvae).
2. Additional studies may not always be necessary, as risk mitigation measures may be sufficient to reduce the risk to an acceptable level and still maintain the usefulness of the product.
3. It may be sufficient to replace one of the default exposure values with a 'real' figure that is relevant to the active substance/product, use and exposure scenario before running a higher tier study, e.g. a field study.
4. It may not be necessary to carry out a higher tier study for every use or crop combination as it may be possible to read across from existing studies. If this approach is used, then it is necessary to ensure that the exposure in terms of both concentrations (in nectar and/or pollen) and duration is appropriate.

---

<sup>10</sup> A factor of 5 is used to determine whether the difference is due to inter-study variability or increased toxicity. The factor is based on SANCO Sanco/10597/2003—rev. 7 final 2, 14 December 2005, which in turn references WHO/FAO (2002) Manual on development and use of FAO and WHO specifications for pesticides. First edition, FAO Plant Production and Protection Paper 173. WHO and FAO, Rome.

The following scenarios have to be considered in the risk assessment:

- **Risk from foraging on the treated crop**
- **Risk from foraging on an adjacent crop**
- **Risk from foraging on weeds in the treated field**
- **Risk from foraging in the field margin**
- **Risk from foraging the following year on a permanent crop or on a succeeding crop for annual crops**

The screening step assessment for oral exposure is based on the worst case scenario, which is in most cases the treated crop except for Bumble bee and Solitary bee larvae for which the worst case is the risk from weeds in the treated field. If the screening step scenario fails then all other scenarios have to be assessed in the first tier unless it is justified that a specific scenario is not relevant because exposure is expected to be negligible.

If the treated crop is not attractive to bees then the treated crop scenario does not need to be assessed. A list of bee attractive crops is provided in [Appendix D](#).

The growth stage of the treated crop needs to be considered. If the application occurs after flowering (from BBCH 70 onwards) then the crop is not attractive for bees and the exposure from foraging on the treated crop is negligible. A standard risk assessment is needed for all other relevant scenarios (e.g. weeds in the treated crop). If a bee attractive crop is treated before flowering (even early growth stages) then a standard assessment is required. This applies to spray applications as well as application of solid formulations.

No clear definition of systemicity exists which could have been used as a trigger for the assessment of the risk from foraging the following year on a permanent crop or on succeeding crop for annual crops (for details see [Appendix N](#)). Therefore an assessment of this scenario has to be conducted for all substances unless the DegT50 is less than 2 days for applications within the same year and 5 days for applications in different years. For further guidance on deriving the DegT50 see EFSA Guidance Document for evaluating laboratory and field dissipation studies to obtain DegT50 values (EFSA, 2014)

### 3.2. Risk assessment schemes for spray applications

Please note that calculated ETR and HQ values should always be reported to one more additional decimal place than the trigger value.

The assessment of oral exposure of adult bees relates to exposure of forager bees and nurse bees from contaminated nectar and pollen. The shortcut values for nurse bees have to be chosen if bees collect only pollen from the treated crop (e.g. maize) and for the assessment of effects on hypopharyngeal gland development. In all other cases the shortcut values for forager bees should be applied.

Is exposure for bees negligible<sup>11</sup>?

---

<sup>11</sup> Examples when exposure of bees is negligible: food storage in enclosed spaces, wound sealing and healing treatments and use in glasshouses without honey bees as pollinators.

If yes, classify risk as negligible for honey bees and go to 3.8 [Assessment of uncertainty and finalization of the risk assessment](#).

If no, proceed with contact and oral exposure assessment (points 3.2.1 [Contact exposure assessment for spray applications](#) and 3.2.2 [Oral exposure assessment for spray applications](#))

### 3.2.1. Contact exposure assessment for spray applications

The following table gives an overview on the screening step and refined assessment HQ calculations for contact exposure. The specific protection goal is achieved if the calculated HQ value is smaller or equal to the trigger value. Refinement of the risk assessment is required if the calculated HQ values are greater than the trigger values (see also 3.7. [Higher tier assessment](#)).

**Table 2** Overview on HQ calculations for spray applications

Type of assessment	Type of bee	Formula screening step assessment	Formula refined assessment	Endpoint	Application rate AR	Trigger values <sup>2</sup>
Acute contact exposure adult bees	Honey bee	HQ <sub>contact</sub> = AR/LD <sub>50</sub> contact	HQ <sub>contact</sub> = $f_{dep} / 100 * AR / LD_{50}$ contact	Acute contact LD <sub>50</sub> μg a.s./bee <sup>1</sup>	g a.s./ha	HQ (DW) > 42
	Bumble bee					HQ (SUW) > 85
	Solitary bee					HQ (DW) > 7
						HQ (SUW) > 14
						HQ (DW) > 8
						HQ (SUW) > 16

HQ(ds) = HQ trigger for downward spray, HQ(sw) = HQ trigger for sideward spray

<sup>1</sup> If the honeybee endpoint is used as a surrogate in the assessment of bumblebees and solitary bees then divide the endpoint by 10

<sup>2</sup> The protection goal is met if the calculated value is smaller or equal to the trigger.

The screening step assessment is based on exposure in the field. In the refined risk assessment also all other scenarios need to be considered (weeds in the treated field, plants in field margins and adjacent crop). For details consult chapters 5.3.2, 5.3.3., 5.3.4, 5.3.5 ([Scenarios for spray applications](#)). The trigger values for downward spray (DW) are applicable for the weeds in field, plants in field margin and adjacent crop scenarios.

In order to refine the risk assessment consider whether it is possible to refine the exposure, for example it may be relevant to consider the spray drift on to the field margin or adjacent crop (adjacent crop is covered by the assessment of field margins). If this refinement is considered appropriate, then the HQ should be recalculated.

$f_{dep}$  = fraction of the dose deposited on foragers visiting plants in the field margin or an adjacent crop (see table H1a below). The  $f_{dep}$  values in table H1a are percentages and therefore the  $f_{dep}$  value is divided by 100 in the equations of the HQ calculations above.

Further details regarding appropriate routes of exposure are presented in [chapter 5.3](#). In addition to considering refining the exposure estimate, it may be appropriate to consider risk mitigation measures (see [chapter 9](#)) or further effects data (see [chapter 6](#)).

**On completion of risk assessment, go to 3.8. [Assessment of uncertainty and finalisation of risk assessment](#).**

**Table H1a:** Deposition percentages to be considered for the refinement of contact exposure in field margins (the original table H1 can be found in [Appendix H](#)).

Application type	Crop	Default deposition ( $f_{dep}$ , in %) to be used for Contact exposure assessment in Field margins
Spray applications (spray drift)	Field crops	2.8
	Orchard – early stage	29.2
	Orchard – late stage	15.7
	Grapevine – early stage	2.7
	Grapevine – late stage	8.0
	Hops	19.3

### 3.2.2. Oral exposure assessment for spray applications

#### **Screening step assessment for oral exposure from spray applications**

The table below gives an overview on the screening step assessment for spray applications and exposure from oral uptake of contaminated pollen and nectar. If the ETR calculations result in values smaller than the trigger value then the specific protection goals are achieved and proceed with 3.8. [Assessment of uncertainty and finalisation of the risk assessment](#). If the calculated ETR value is greater than the trigger then proceed with the 1<sup>st</sup> tier assessment (3.7. [Higher tier risk assessment](#)).

**Table 3:** Overview Screening step assessment calculations for spray compounds and oral exposure.

Type of assessment	Type of bee	Formula	Endpoint	Application rate AR	Shortcut value SV		Trigger values <sup>2</sup>
					Down-ward	Side-ward	
Acute oral exposure adult bees	Honey bee	ETR <sub>acute adult oral</sub> = AR * SV/LD <sub>50oral</sub>	Acute oral LD <sub>50</sub> µg a.s./bee <sup>1</sup>	kg a.s./ha	7.6	10.6	ETR > 0.2
	Bumble bee				11.2	13.3	ETR > 0.036
	Solitary bee				5.7	7.3	ETR > 0.04
Chronic oral exposure adult bees	Honey bee	ETR <sub>chronic adult oral</sub> = AR * SV/10 d LDD <sub>50</sub>	Chronic oral 10 d LDD <sub>50</sub> <sup>3,1</sup> µg a.s./bee per day	kg a.s./ha	7.6	10.6	ETR > 0.03
	Bumble bee				11.2	13.3	ETR > 0.0048
	Solitary bee				5.7	7.3	ETR > 0.0054
Chronic oral exposure larvae	Honey bee	ETR <sub>larvae</sub> = AR * SV/NOEL <sub>larvae</sub>	NOEL <sub>larvae</sub> <sup>1</sup> µg a.s./larvae per developmental period	kg a.s./ha	4.4	6.1	ETR > 0.2
	Bumble bee	ETR <sub>larvae</sub> <sup>4</sup> = AR * SV * 10/NOEL <sub>larvae</sub>			4.5	2.6	ETR > 0.2
	Solitary bee	ETR <sub>larvae</sub> = AR * SV/NOEL <sub>larvae</sub>			33.6	30.8	ETR > 0.2
Sublethal Development of hypopharyngeal glands	Honey bee (nurse)	ETR <sub>hpg</sub> = AR * SV/NOEL <sub>hpg</sub>	NOEL <sub>hpg</sub> µg a.s./bee per day	kg a.s./ha	7.6	10.6	ETR > 1

<sup>1</sup> If the honeybee endpoint is used as a surrogate in the assessment of bumblebees and solitary bees then divide the endpoint by 10

<sup>2</sup> The protection goal is met if the calculated value is smaller or equal to the trigger. If the calculated value is greater than the trigger value then proceed with the 1<sup>st</sup> tier risk assessment.

<sup>3</sup> The chronic 10-d endpoint is expressed in terms of µg a.s./bee (lethal dietary dose). The same endpoint is in literature often referred to as 10-d LC50.

<sup>4</sup> The shortcut value was calculated for consumption over 1 day, therefore the shortcut value needs to be multiplied by 10 in order to account for exposure over the whole developmental period of bumblebee larvae.

**On completion of risk assessment go to 3.8. [Assessment of uncertainty and finalisation of risk assessment.](#)**

### **1<sup>st</sup> tier assessment for oral exposure from spray applications**

The scenarios listed below in Table 4 need to be considered in the 1<sup>st</sup> tier assessment. The shortcut values (SV) and exposure factors (Ef) relevant for the ETR calculations for the different scenarios can be found in tables Jx and Jy and in table X1.

**Table 4:** The different scenarios to be considered in the first tier assessment for oral exposure from spray applications.

<b>1<sup>st</sup> tier Scenario</b>	<b>Exposure factor (Ef)</b>	<b>Short cut value (SV)</b>
<b>Risk from foraging on the treated crop</b>	Not applicable*	Table Jx
<b>Risk from foraging on an adjacent crop</b>	Table X1a	Table Jx
<b>Risk from foraging on weeds in the treated field</b>	Table X1a	Table Jy
<b>Risk from foraging in the field margin</b>	Table X1a	Table Jy
<b>Risk from foraging the following year on a permanent crop or on a succeeding crop for annual crops</b>	Not applicable*	Table Jy

\* value of 1 should be used in the ETR calculation for mathematical solution of the equation

The table below gives an overview on the first tier calculations and trigger values. The calculations have to be repeated for each of the relevant scenarios in the table above.

**Table 5:** 1<sup>st</sup> tier calculations for oral exposure from spray applications

Type of assessment	Type of bee	Formula	Endpoint	Application rate AR	twa	Trigger values <sup>2</sup>
Acute oral exposure adult bees	Honey bee	$ETR_{acute\ adult\ oral} = AR * Ef * SV / LD_{50\ oral}$	Acute oral	kg a.s./ha	-	ETR > 0.2
	Bumble bee		LD <sub>50</sub>		-	ETR > 0.036
	Solitary bee		µg a.s./bee <sup>1</sup>		-	ETR > 0.04
Chronic oral exposure adult bees	Honey bee	$ETR_{chronic\ adult\ oral} = AR * Ef * SV * twa / 10\ d\ LDD_{50}$	Chronic oral 10 d LDD <sub>50</sub> <sup>3, 1</sup> µg a.s./bee per day	kg a.s./ha	0.72	ETR > 0.03
	Bumble bee				0.72	ETR > 0.0048
	Solitary bee				0.72	ETR > 0.0054
Chronic oral exposure larvae	Honey bee	$ETR_{larvae} = AR * Ef * SV / NOEL_{larvae}$	NOEL <sub>larvae</sub> <sup>1</sup> µg a.s./larvae per developmental period	kg a.s./ha	0.85	ETR > 0.2
	Bumble bee	$ETR_{larvae}^4 = AR * Ef * SV * 10 * twa / NOEL_{larvae}$			1	ETR > 0.2
	Solitary bee	$ETR_{larvae} = AR * Ef * SV / NOEL_{larvae}$			1	ETR > 0.2
Sublethal Development of hypopharyngeal glands	Honey bee (nurse)	$ETR_{hpg} = AR * Ef * SV / NOEL_{hpg}$	NOEL <sub>hpg</sub> µg a.s./bee per day	kg a.s./ha	0.72	ETR > 1

The twa value of 0.72 is based on a default DT50 of 10 days and a 10-day time window (see also (EFSA, 2009)). The twa value of 0.85 is based on a default DT50 of 10 days and a 5-day time window. It is not considered possible to derive a default twa factor for the initial risk assessment tiers for bumble bee larvae as some bumble bee species feed larvae only once with pollen and hence a default twa of 1 should be used. However residue decline in nectar may be an option to refine the risk assessment. A twa is not applicable for solitary bee larvae as these tend to be fed on one day only, hence exposure will be a once-off exposure.

<sup>1</sup> If the honeybee endpoint is used as a surrogate in the assessment of bumblebees and solitary bees then divide the endpoint by 10

<sup>2</sup> The protection goal is met if the calculated ETR value is smaller than the trigger.

<sup>3</sup> The chronic 10-d endpoint is expressed in terms of  $\mu\text{g a.s./bee}$  per day (lethal dietary dose). The same endpoint is in literature often referred to as 10-d LC50.

<sup>4</sup> The shortcut value was calculated for consumption over 1 day, therefore the shortcut value needs to be multiplied by 10 in order to account for exposure over the whole developmental period of bumblebee larvae.

The specific protection goals are met if the ETR calculations result in values smaller or equal to the trigger. ETR values greater than the trigger require further refinement of the risk assessment (see 3.7. [Higher tier risk assessment](#)).

**On completion of the risk assessment proceed to 3.8. [Assessment of uncertainties and finalisation of the risk assessment](#).**

**Table X1a:** Exposure factor table for different scenarios and spray treatments. (The original tableX1 can be found in [Appendix X](#)).

Scenario	Exposure factor (-)
Weeds in the field	$f_{dep}$ Take the relevant deposition factor ( $f_{dep}$ ) value from table X2a below.
Plants at the field margin	Field crops: 0.0092 Orchard – early stage: 0.097 Orchard – late stage: 0.052 Grapevine – early stage: 0.009 Grapevine – late stage: 0.027 Hops: 0.064
Adjacent crop	Field crops: 0.0033 Orchard – early stage: 0.066 Orchard – late stage: 0.031 Grapevine – early stage: 0.0047 Grapevine – late stage: 0.0143 Hops: 0.041

**Table X2a:** Deposition factors to be used for the weeds in the treated field scenario (original title: Deposition factors for bird and mammal plant food items according to BBCH growth stages (derived from FOCUS, 2001)). The original table X2 can be found in [Appendix X](#).

Crop	Relevant principal BBCH growth stage	Deposition Factor ( $f_{dep}$ )
Bare soil	Not applicable	-
Bulb vegetables	$\geq 4$	0.6
Bush and cane fruit (not tabulated, surrogate value from vineyard)	$\geq 1$	0.6
	$\geq 2$	0.5
	$\geq 4$	0.3
Cereals	$\geq 3$	0.5
	$\geq 4$	0.3
Cotton	$\geq 5$	0.25
Fruiting vegetables	$\geq 5$	0.3
Grassland	Not applicable	-
Hop	$\geq 1$	Not applicable**
	$\geq 2$	0.5
	$\geq 4$	0.3
Leafy vegetables	$\geq 5$	0.3
Legume forage	$\geq 5$	0.3
Maize	$\geq 3$	0.5
	$\geq 4$	0.25
Oilseed rape	$\geq 3$	0.3
	$\geq 4$	0.25
Orchards	$\geq 1$	0.8
	$\geq 2$	0.6
	$\geq 4$	0.3
Ornamentals/nursery (not tabulated, surrogate value from leafy vegetables)	$\geq 5$	0.3
Potatoes	$\geq 4$	0.3
Pulses	$\geq 5$	0.3
Root and stem vegetables	$\geq 4$	0.3
Strawberries*	$\geq 4$	0.4
Sugar beet	$\geq 4$	0.25
Sunflower	$\geq 3$	0.5
	$\geq 4$	0.25
Vineyard	$\geq 1$	0.6
	$\geq 2$	0.5
	$\geq 4$	0.3

\*The strawberry scenario is different from other arable fields, because the crop is typically grown in rows separated by broad bare soil strips, with either crop-directed treatments using three-nozzle fork sprayer (fungicides, insecticides) or between-row treatments (herbicides).

\*\*No consideration of interception for hops before side shoot formation, because it is cultivated like an arable crop at this early stage.

Notes:

A scenario for pre-emergence applications (bare soil) when weeds are present is missing from the table. A  $f_{dep}$  of 1 should be used for those situations.

In some circumstances, such as (but not restricted to) application of herbicides in crops planted in wide rows (i.e. orchards, vines, strawberry, bush and cane crops), the pesticide application is not crop directed (e.g. spray application between the rows or under the trees). For those situations there is no interception by the crop and hence the  $f_{dep}$  of 1 should be used for weeds.

**Table Jx:** Shortcut values relevant for spray applications after emergence of the treated crop (i.e. BBCH  $\geq$  10) and before emergence of the treated crop (BBCH <10). The original tables J4, J5 and J6 can be found in [Appendix J](#).

Scenario	Treated crop - application after emergence (downward spraying) and adjacent crop (regardless of application method)			Treated crop - application after emergence (sideward or upward spraying)			Treated crop - application before emergence (both downward and side/upward spray)		
	SV ( $\mu\text{g}$ )			SV ( $\mu\text{g}$ )			SV ( $\mu\text{g}$ )		
Category	Crop attractive for pollen and nectar	Crop attractive for pollen, only	Crop attractive for nectar, only	Crop attractive for pollen and nectar	Crop attractive for pollen, only	Crop attractive for nectar, only	Crop attractive for pollen and nectar	Crop attractive for pollen, only	Crop attractive for nectar, only
HB forager acute	7.6	N/A*	7.6	10.6	N/A*	10.6	0.70	N/A*	0.70
HB forager chronic	5.8		5.8	8.2		8.2	0.54		0.54
HB nurse	3.8	0.92	3.0	4.3	0.06	4.3	0.29	0.012	0.28
HB larva	4.4	0.15	4.3	6.1	0.01	6.1	0.40	0.002	0.40
BB adult acute	11.2	2.3	9.4	13.3	0.15	13.3	0.90	0.03	0.87
BB adult chronic	9.9		8.1	11.4		11.3	0.78		0.75
BB larva	4.5	3.0	1.7	2.5	0.20	2.4	0.20	0.04	0.16
SB adult	5.7	0.78	5.2	7.3	0.05	7.3	0.49	0.01	0.48
SB larva	33.6	29.9	5.8	9.6	1.9	8.3	0.93	0.39	0.54

Note: if the adjacent crops are not defined, consider that the crops are attractive for both the pollen and nectar. The adjacent crop scenario is independent of the timing of application and relevant also for applications before emergence of the crop.

\*: not applicable as the pollen consumption of forager HB is negligible. For a risk assessment for adult HB, the SV for nurse should be used.

**Table Jy:** Shortcut values relevant for all spray applications (before and after emergence of crop). The original tables J6, J7 and J8 can be found in [Appendix J](#).

Scenario	Succeeding crop and Permanent crop next year			Weeds in the field (application after emergence of weeds) and plants in field margins	Weeds in the field (application before emergence of weeds)
	SV (µg)			SV(µg)	SV(µg)
Category	Crop attractive for pollen and nectar	Crop attractive for pollen, only	Crop attractive for nectar, only	Plants attractive for pollen and nectar	Plants attractive for pollen and nectar
HB forager acute	0.70	N/A*	0.70	3.7	0.35
HB forager chronic	0.54		0.54	2.9	0.27
HB nurse	0.29	0.012	0.28	2.1	0.15
HB larva	0.40	0.002	0.40	2.2	0.20
BB adult acute	0.90	0.03	0.87	6.5	0.46
BB adult chronic	0.78		0.75	5.9	0.40
BB larva	0.20	0.04	0.16	2.6	0.11
SB adult	0.49	0.01	0.48	2.3	0.17
SB larva	0.93	0.39	0.54	30.8	0.57

Note: if the succeeding crops are not defined, consider that the crops are attractive for both the pollen and nectar. The adjacent crop scenario is independent of the timing of application and relevant also for applications before emergence of the crop. The shortcut values for adjacent crops can be found in table Jx above.

### 3.3. Risk assessment schemes for solid formulations

Please note that calculated ETR and HQ values should always be reported to one more additional decimal place than the trigger value.

The assessment of oral exposure of adult bees relates to exposure of forager bees and nurse bees from contaminated nectar and pollen. The shortcut values for nurse bees have to be chosen if bees collect only pollen from the treated crop (e.g. maize) and for the assessment of effects on hypopharyngeal gland development. In all other cases the shortcut values for forager bees should be applied.

Is exposure for bees negligible<sup>12</sup>?

If yes, classify risk as negligible for honey bees and go to 3.8 [Assessment of uncertainty and finalization of the risk assessment](#).

If no, proceed with contact and oral exposure assessment (points 3.3.1 [Contact exposure assessment for solid formulations](#) and 3.3.2 [Oral exposure assessment for solid formulations](#).)

#### 3.3.1. Contact exposure assessment for solid formulations

The following table gives an overview on the screening step of contact exposure for seed treatments and granular applications. If the HQ value calculated according to the formula for the screening step assessment is below the trigger value then refinement of the risk assessment is required.

**Table 6:** Overview on the HQ calculations for the contact exposure assessment

Type of assessment	Type of bee	Formula screening step assessment for seed treatments and soil incorporated granules (field margin scenario)	Formula screening step for post emergence granular applications (broadcast) (treated crop scenario)	Endpoint	Application rate AR	Trigger values <sup>2</sup>
Acute contact exposure adult bees	Honey bee	$HQ_{\text{contact}} = \frac{f_{\text{dep}}}{100} \cdot \frac{AR}{LD_{50} \text{ contact}} *$	$HQ_{\text{contact}} = 0.1 \cdot \frac{AR}{LD_{50} \text{ contact}} *$	Acute contact LD <sub>50</sub> µg a.s./bee <sup>1</sup>	g a.s. /ha	HQ > 14
	Bumble bee					HQ > 2.5
	Solitary bee					HQ > 2.5

<sup>1</sup> If the honeybee endpoint is used as a surrogate in the assessment of bumblebees and solitary bees then divide the endpoint by 10.

<sup>12</sup> Examples when exposure of bees is negligible: food storage in enclosed spaces, wound sealing and healing treatments and use in glasshouses without honey bees as pollinators.

<sup>2</sup> The protection goal is met if the calculated value is smaller or equal to the trigger. The trigger values established for sprayed compounds were divided by a factor of 3 in order to account for potential higher residues on bees from contact to dust particles.

$f_{dep}$  = fraction of the dose deposited on foragers visiting plants in the field margin or an adjacent crop (see table H1b below). The  $f_{dep}$  values in table H1a are percentages and therefore the  $f_{dep}$  value is divided by 100 in the equations of the HQ calculations above.

If the use of the granule being considered does not fit either the application at the time of drilling or broadcast category, then the risk should be assessed on a case-by-case basis to ensure that all possible routes of exposure are assessed. It should be noted that there may be granules that may be surface broadcast and applied at the time of drilling (e.g. slug pellets may be admixed in to the seed or surface broadcast). In these instances, the risk from both uses should be considered.

If the screening step fails then the risk needs to be addressed als for all other relevant scenarios. For broadcast granules which are applied post emergence also the weeds in treated field and plants in the field margins need to be addressed. Adjacent crops are covered by the assesment of plants in field margins. For seed treatments and granules applied pre-emergence the only relevant scenario is plant in the field margins. The other scenarios will be covered by this assessment. Further details regarding appropriate routes of exposure are presented in chapter 5.4 and 5.5 ([Seed treatments](#) and [granules](#)) In addition to considering refining the exposure estimate, it may be appropriate to consider risk mitigation measures (see [chapter 9](#)) or further effects data (see [chapter 6](#)). On completion of risk assessment, go to 3.8. [Assessment of uncertainty and finalisation of the risk assessment](#).

**Table H1b:** Deposition percentages to be considered for the contact exposure in field margins. The original table H1b can be found in [Appendix H](#).

<b>Application type</b>	<b>Crop</b>	<b>Default deposition (<math>f_{dep}</math> in %) to be used for Contact exposure assessment in Field margins</b>
Seed treatments (dust drift)	Maize with deflector	1.7
	Maize without deflector	17
	Oilseed rape with deflector	0.66
	Oilseed rape without deflector	6.6
	Cereals with deflector	0.99
	Cereals without deflector	9.9
	Sugar beets with deflector	0.003
	Sugar beets without deflector	0.03
Granule applications (dust drift)	All crops	9.6

Notes: the default deposition for maize should be used for seed treated crops which are not listed in the table

### 3.3.2. Oral exposure assessment for solid applications

#### **Screening step assessment for oral exposure from solid applications**

The table 7 below gives an overview on the calculations for the screening step assessment for oral exposure for seed treatments, granules applied before emergence (soil incorporated) and granules applied after emergence (broadcast application).

The ETR calculations based on kg a.s./ha have to be conducted for seed treatments, granules applied pre-emergence during drilling of seeds (soil incorporated) and for granules applied after emergence (broadcast application). Additional ETR calculations based on mg a.s./seed should be conducted for seed treatments for the treated crop scenario.

If the ETR calculations result in values smaller than the trigger then the protection goal is achieved and it can be proceeded with point 3.8. [Assessment of uncertainty and finalisation of the risk assessment](#). If the calculated ETR value is greater than the trigger then proceed to the 1<sup>st</sup> tier assessment (3.7. [Higher tier risk assessment](#)).

**Table 7:** Overview on screening step ETR calculations for oral exposure from solid applications.

Type of assessment	Type of bee	Formula	Endpoint	Application rate AR	Exposure factor Ef	Shortcut value SV	Trigger values <sup>2</sup>
Acute exposure bees	oral adult	Honey bee	Acute oral LD <sub>50</sub> µg a.s./bee <sup>1</sup>	kg a.s./ha	0.3	7.6	ETR > 0.2
	Bumble bee	ETR <sub>acute adult oral</sub> = AR * Ef * SV/LD <sub>50</sub> oral					ETR > 0.036
	Solitary bee	ETR <sub>acute adult oral</sub> = AR * Ef * SV/LD <sub>50</sub> oral					ETR > 0.04
Chronic exposure bees	oral adult	Honey bee	Chronic oral 10 d LDD <sub>50</sub> <sup>3, 1</sup> µg a.s./bee per day	kg a.s./ha	0.3	7.6	ETR > 0.03
	Bumble bee	ETR <sub>chronic adult oral</sub> = AR * Ef * SV/10 d LDD <sub>50</sub>					ETR > 0.0048
	Solitary bee	ETR <sub>chronic adult oral</sub> = AR * Ef * SV/10 d LDD <sub>50</sub>					ETR > 0.0054
Chronic exposure larvae	oral	Honey bee	NOEL <sub>larvae</sub> <sup>1</sup> µg a.s./larvae per developmental period (5 days)	kg a.s./ha	0.3	4.4	ETR > 0.2
	Bumble bee	ETR <sub>larvae</sub> <sup>4</sup> = AR * Ef * SV * 10/NOEL <sub>larvae</sub>					ETR > 0.2
	Solitary bee	ETR <sub>larvae</sub> = AR * Ef * SV/NOEL <sub>larvae</sub>					ETR > 0.2
Sublethal Development of hypopharyngeal glands	Honey bee	ETR <sub>hpg</sub> = AR * Ef * SV/NOEL <sub>hpg</sub>	NOEL <sub>hpg</sub> µg a.s./bee per day	kg a.s./ha	0.3	7.6	ETR > 1

**The calculations below based on mg a.s./seed are relevant only for seed treatments for the treated crop scenario**

Type of assessment	Type of bee	Formula	Endpoint	Application rate AR	Exposure factor Ef	Shortcut value SV	Trigger values <sup>2</sup>
Acute oral exposure adult bees	Honey bee	$ETR_{\text{acute adult oral}} = AR * SV / LD_{50 \text{ oral}}$	Acute oral $LD_{50}$ $\mu\text{g a.s./bee}^1$	mg a.s./seed	-	0.7	$ETR > 0.2$
	Bumble bee	$ETR_{\text{acute adult oral}} = AR * SV / LD_{50 \text{ oral}}$		mg a.s./seed	-	0.9	$ETR > 0.036$
	Solitary bee	$ETR_{\text{acute adult oral}} = AR * SV / LD_{50 \text{ oral}}$		mg a.s./seed	-	0.49	$ETR > 0.04$
Chronic oral exposure adult bees	Honey bee	$ETR_{\text{chronic adult oral}} = AR * SV / 10 \text{ d } LDD_{50}$	Chronic oral $10 \text{ d } LDD_{50}^{3,1}$ $\mu\text{g a.s./bee per day}$	mg a.s./seed	-	0.7	$ETR > 0.03$
	Bumble bee	$ETR_{\text{chronic adult oral}} = AR * SV / 10 \text{ d } LDD_{50}$		mg a.s./seed	-	0.9	$ETR > 0.0048$
	Solitary bee	$ETR_{\text{chronic adult oral}} = AR * SV / 10 \text{ d } LDD_{50}$		mg a.s./seed	-	0.49	$ETR > 0.0054$
Chronic oral exposure larvae	Honey bee	$ETR_{\text{larvae}} = AR * SV / NOEL_{\text{larvae}}$	$NOEL_{\text{larvae}}^1$ $\mu\text{g a.s./larvae per developmental period (5 days)}$	mg a.s./seed	-	0.4	$ETR > 0.2$
	Bumble bee	$ETR_{\text{larvae}}^4 = AR * SV * 10 / NOEL_{\text{larvae}}$		mg a.s./seed	-	0.2	$ETR > 0.2$
	Solitary bee	$ETR_{\text{larvae}} = AR * SV / NOEL_{\text{larvae}}$		mg a.s./seed	-	0.93	$ETR > 0.2$
Sublethal Development of hypopharyngeal glands	Honey bee (nurse)	$ETR_{\text{hpg}} = AR * SV / NOEL_{\text{hpg}}$	$NOEL_{\text{hpg}}$ $\mu\text{g a.s./bee per day}$	mg a.s./seed	-	0.7	$ETR > 1$

<sup>1</sup> If the honeybee endpoint is used as a surrogate in the assessment of bumblebees and solitary bees then divide the endpoint by 10

<sup>2</sup> The protection goal is met if the calculated ETR value is smaller than the trigger.

<sup>3</sup> The chronic 10-d endpoint is expressed in terms of  $\mu\text{g a.s./bee}$  (lethal dietary dose). The same endpoint is in literature often referred to as 10-d  $LC_{50}$ .

<sup>4</sup> The shortcut value was calculated for consumption over 1 day, therefore the shortcut value needs to be multiplied by 10 in order to account for exposure over the whole developmental period of bumblebee larvae.

### **1<sup>st</sup> tier assessment for oral exposure from solid formulations**

The table 9 below gives an overview on the calculations for the 1<sup>st</sup> tier assessment for oral exposure for seed treatments, granules applied before emergence (soil incorporated) and granules applied after emergence (broadcast application).

The calculation based on an application rate expressed as mg a.s./seed is relevant only for the treated crop scenario for seed treatments. The calculation based on application rates expressed in kg a.s./ha are applicable for all other scenarios for seed treatments. The same calculations based on kg a.s./ha are also relevant for granules applied during drilling of seeds (soil incorporated) and for granules applied after emergence (broadcast application). The different unit for the treated crop scenario for seed treatments (i.e. the mg/seed) is based on the assumption that the residue level in pollen and nectar of the individual crop plants are related to the seed loading rate of those individual plants rather than the total mass applied to a certain cropped area (i.e. application rate per hectare).

The calculations have to be repeated for each of the relevant scenarios. The calculation based on an application rate expressed as mg a.s./seed is relevant only for seed treatments for the treated crop scenario. The relevant shortcut values (SV) for the different scenarios can be found in tables Jxx and Jyy. The relevant exposure factors (Ef) can be found in table X1b and X1c. For scenarios which are not listed in table X1b and X1c (treated crop, succeeding crop) no exposure factor (Ef) is applicable (as a mathematical solution for the equation, the value of 1 is used). Please note that the 1<sup>st</sup> tier assessment needs to be conducted only for those scenarios for which the screening step failed. This applies also to the exposure calculations for seed treatments. If for example only the assessment based on kg a.s./ha is above the trigger and the assessment based on mg a.s./seed is below the trigger then the 1<sup>st</sup> tier assessment needs to be conducted only for the risk assessment based on kg a.s./ha.

The scenarios listed below in Table 8 need to be considered in the 1<sup>st</sup> tier assessment. The shortcut values (SV) and exposure factors (Ef) relevant for the ETR calculations for the different scenarios can be found in tables Jx and Jy and in table X1.

**Table 8** Overview on the different scenarios to be considered in the first tier assessment.

1 <sup>st</sup> tier Scenario	Seed treatment or granules applied pre-emergence (in-soil)		Granules applied post emergence (broadcast application)	
	Exposure factor (Ef)	Short cut value (SV)	Exposure factor (Ef)	Short cut value (SV)
<b>Risk from foraging on the treated crop</b>	Not relevant*	Table Jxx	0.3	Table Jyy
<b>Risk from foraging on an adjacent crop</b>	Table X1b	Table Jyy	Table X1c	Table Jyy
<b>Risk from foraging on weeds in the treated field</b> This scenario is not relevant for seed treatments	Table X1b	Table Jxx	Table X1c	Table Jyy
<b>Risk from foraging in the field margin</b>	Table X1b	Table Jxx	Table X1c	Table Jyy
<b>Risk from foraging the following year on a permanent crop or on a succeeding crop for annual crops</b>	Not relevant*	Table Jxx	Not relevant*	Table Jyy

\* value of 1 should be used in the ETR calculation for mathematical solution of the equation

**Table 9:** Overview on 1<sup>st</sup> tier ETR calculations for oral exposure from solid applications.

Type of assessment	Type of bee	Formula	Endpoint	Application rate AR	twa	Trigger values <sup>2</sup>
Acute exposure bees	oral adult	Honey bee $ETR_{acute\ adult\ oral} = AR * Ef * SV / LD_{50\ oral}$	Acute oral $LD_{50}$ $\mu g\ a.s./bee^1$	kg a.s./ha	-	ETR > 0.2
	Bumble bee $ETR_{acute\ adult\ oral} = AR * Ef * SV / LD_{50\ oral}$	kg a.s./ha		-	ETR > 0.036	
	Solitary bee $ETR_{acute\ adult\ oral} = AR * Ef * SV / LD_{50\ oral}$	kg a.s./ha		-	ETR > 0.04	
Chronic exposure bees	oral adult	Honey bee $ETR_{chronic\ adult\ oral} = AR * Ef * SV * twa / 10\ d\ LDD_{50}$	Chronic oral $10\ d\ LDD_{50}^{3,1}$ $\mu g\ a.s./bee\ per\ day$	kg a.s./ha	1	ETR > 0.03
	Bumble bee $ETR_{chronic\ adult\ oral} = AR * Ef * SV * twa / 10\ d\ LDD_{50}$	kg a.s./ha		1	ETR > 0.0048	
	Solitary bee $ETR_{chronic\ adult\ oral} = AR * Ef * SV / 10\ d\ LDD_{50}$	kg a.s./ha		1	ETR > 0.0054	
Chronic exposure larvae	oral	Honey bee $ETR_{larvae} = AR * Ef * SV * twa / NOEL_{larvae}$	NOEL <sub>larvae</sub> <sup>1</sup> $\mu g\ a.s./larvae\ per\ developmental\ period\ (5\ days)$	kg a.s./ha	1	ETR > 0.2
	Bumble bee $ETR_{larvae} = AR * Ef * SV * 10 * twa / NOEL_{larvae}$	kg a.s./ha		1	ETR > 0.2	
	Solitary bee $ETR_{larvae} = AR * Ef * SV * twa / NOEL_{larvae}$	kg a.s./ha		1	ETR > 0.2	
Sublethal Development of hypopharyngeal glands	Honey bee	$ETR_{hpg} = AR * Ef * SV * twa / NOEL_{hpg}$	NOEL <sub>hpg</sub> $\mu g\ a.s./bee\ per\ day$	kg a.s./ha	1	ETR > 1

The calculations below based on mg a.s./seed are relevant only for seed treatments for the treated crop scenario						
Type of assessment	Type of bee	Formula	Endpoint	Application rate AR	twa	Trigger values <sup>2</sup>
Acute oral exposure adult bees	Honey bee	$ETR_{\text{acute adult oral}} = AR * SV / LD_{50 \text{ oral}}$	Acute oral $LD_{50}$ $\mu\text{g a.s./bee}^1$	mg a.s./seed	-	$ETR > 0.2$
	Bumble bee	$ETR_{\text{acute adult oral}} = AR * SV / LD_{50 \text{ oral}}$		mg a.s./seed	-	$ETR > 0.036$
	Solitary bee	$ETR_{\text{acute adult oral}} = AR * SV / LD_{50 \text{ oral}}$		mg a.s./seed	-	$ETR > 0.04$
Chronic oral exposure adult bees	Honey bee	$ETR_{\text{chronic adult oral}} = AR * SV * twa / 10 \text{ d } LDD_{50}$	Chronic oral $10 \text{ d } LDD_{50}^{3,1}$ $\mu\text{g a.s./bee per day}$	mg a.s./seed	1	$ETR > 0.03$
	Bumble bee	$ETR_{\text{chronic adult oral}} = AR * SV * twa / 10 \text{ d } LDD_{50}$		mg a.s./seed	1	$ETR > 0.0048$
	Solitary bee	$ETR_{\text{chronic adult oral}} = AR * SV / 10 \text{ d } LDD_{50}$		mg a.s./seed	1	$ETR > 0.0054$
Chronic oral exposure larvae	Honey bee	$ETR_{\text{larvae}} = AR * SV * twa / NOEL_{\text{larvae}}$	$NOEL_{\text{larvae}}^1$ $\mu\text{g a.s./larvae per developmental period}$	mg a.s./seed	1	$ETR > 0.2$
	Bumble bee	$ETR_{\text{larvae}} = AR * SV * 10 * twa / NOEL_{\text{larvae}}$		mg a.s./seed	1	$ETR > 0.2$
	Solitary bee	$ETR_{\text{larvae}} = AR * SV * twa / NOEL_{\text{larvae}}$		mg a.s./seed	1	$ETR > 0.2$
Sublethal, Development of hypopharyngeal glands	Honey bee (nurse)	$ETR_{\text{hpg}} = AR * SV * twa / NOEL_{\text{hpg}}$	$NOEL_{\text{hpg}}$ $\mu\text{g a.s./bee per day}$	mg a.s./seed	1	$ETR > 1$

Notes: It is not considered possible to derive a default twa factor for the initial risk assessment tiers for bumble bee larvae as some bumble bee species feed larvae only once with pollen and hence a default twa of 1 should be used. However residue decline in nectar may be an option to refine the risk assessment. A twa is not applicable for solitary bee larvae as these tend to be fed on one day only, hence exposure will be a once-off exposure.

<sup>1</sup> If the honeybee endpoint is used as a surrogate in the assessment of bumblebees and solitary bees then divide the endpoint by 10.

<sup>2</sup> The protection goal is met if the calculated ETR value is smaller than the trigger.

<sup>3</sup> The chronic 10-d endpoint is expressed in terms of  $\mu\text{g a.s./bee per day}$  (lethal dietary dose). The same endpoint is in literature often referred to as 10-d  $LC_{50}$ .

The specific protection goals are met if the ETR calculations result in values smaller or equal to the trigger. ETR values greater than the trigger require further refinement of the risk assessment (see 3.7. [Higher tier risk assessment](#)).

**On completion of the risk assessment proceed to 3.8. [Assessment of uncertainties and finalisation of the risk assessment](#).**

**Exposure factor tables for different scenarios for solid formulations:**

**Table X1b:** Exposure factors for seed treatments. The original table X1 can be found in [Appendix X](#).

Scenario	Exposure factor
Plants at the field margin	Maize with deflector: 0.0168 Maize without deflector: 0.168 Oilseed rape with deflector: 0.0066 Oilseed rape without deflector: 0.066 Cereals with deflector: 0.0099 Cereals without deflector: 0.099 Sugar beets with deflector: 0.00003 Sugar beets without deflector: 0.0003
Adjacent Crop	Maize with deflector: 0.0081 Maize without deflector: 0.081 Oilseed rape with deflector: 0.0033 Oilseed rape without deflector: 0.033 Cereals with deflector: 0.0048 Cereals without deflector: 0.048 Sugar beets with deflector: 0.000015 Sugar beets without deflector: 0.00015

Note: for risk assessments for those crops those are not listed here, the factors for maize should be used.

**Table X1c:** Exposure factors for granular applications. The original table X1 can be found in [Appendix X](#).

Scenario	Exposure factor
Treated crop*	0.3
Weeds in the field	$0.3 \times f_{dep}$  Take the relevant deposition factor ( $f_{dep}$ ) value from table X2 below.
Plants at the field margin	0.096
Adjacent crop	0.045

\*Relevant only for granules for broadcast application after emergence and not relevant for granules applied before emergence.

**Table X2:** Deposition factors to be used for the weeds in the treated field scenario (original title: Deposition factors for bird and mammal plant food items according to BBCH growth stages (derived from FOCUS, 2001)).

Crop	Relevant principal BBCH growth stage	Deposition Factor ( $f_{dep}$ )
Bare soil	Not applicable	-
Bulb vegetables	$\geq 4$	0.6
Bush and cane fruit (not tabulated, surrogate value from vineyard)	$\geq 1$	0.6
	$\geq 2$	0.5
	$\geq 4$	0.3
Cereals	$\geq 3$	0.5
	$\geq 4$	0.3
Cotton	$\geq 5$	0.25
Fruiting vegetables	$\geq 5$	0.3
Grassland	Not applicable	-
Hop	$\geq 1$	Not applicable**
	$\geq 2$	0.5
	$\geq 4$	0.3
Leafy vegetables	$\geq 5$	0.3
Legume forage	$\geq 5$	0.3
Maize	$\geq 3$	0.5
	$\geq 4$	0.25

**Table X2:** Deposition factors to be used for the weeds in the treated field scenario (original title: Deposition factors for bird and mammal plant food items according to BBCH growth stages (derived from FOCUS, 2001)).

Oilseed rape	$\geq 3$	0.3
	$\geq 4$	0.25
Orchards	$\geq 1$	0.8
	$\geq 2$	0.6
	$\geq 4$	0.3
Ornamentals/nursery (not tabulated, surrogate value from leafy vegetables)	$\geq 5$	0.3
Potatoes	$\geq 4$	0.3
Pulses	$\geq 5$	0.3
Root and stem vegetables	$\geq 4$	0.3
Strawberries*	$\geq 4$	0.4
Sugar beet	$\geq 4$	0.25
Sunflower	$\geq 3$	0.5
	$\geq 4$	0.25
Vineyard	$\geq 1$	0.6
	$\geq 2$	0.5
	$\geq 4$	0.3

\*The strawberry scenario is different from other arable fields, because the crop is typically grown in rows separated by broad bare soil strips, with either crop-directed treatments using three-nozzle fork sprayer (fungicides, insecticides) or between-row treatments (herbicides).

\*\*No consideration of interception for hops before side shoot formation, because it is cultivated like an arable crop at this early stage.

Notes: a scenario for pre-emergence applications (bare soil) when weeds are present is missing from the table. A  $f_{dep}$  of 1 should be used for those situations.

**Table Jxx:** Shortcut values for seed treatments and granules applied before emergence (soil incorporated) The original tables J6, J7 and J8 can be found in [Appendix J](#).

Scenario	Treated crop (seed treatments and granules applied before crop emergence) and Succeeding crop or Permanent crop next year			Plants in field margins	Weeds in the field (application after emergence of weeds)	Weeds in the field (application before emergence of weeds)
	SV (µg)			SV(µg)	SV(µg)	SV(µg)
Category	Crop attractive for pollen and nectar	Crop attractive for pollen, only	Plants attractive for pollen and nectar	Crop attractive for pollen and nectar	Plants attractive for pollen and nectar	Plants attractive for pollen and nectar
HB forager acute	0.70	N/A*	0.70	3.7	3.7	0.35
HB forager chronic	0.54		0.54	2.9	2.9	0.27
HB nurse	0.29	0.012	0.28	2.1	2.1	0.15
HB larva	0.40	0.002	0.40	2.2	2.2	0.20
BB adult acute	0.90	0.03	0.87	6.5	6.5	0.46
BB adult chronic	0.78		0.75	5.9	5.9	0.40
BB larva	0.20	0.04	0.16	2.6	2.6	0.11
SB adult	0.49	0.01	0.48	2.3	2.3	0.17
SB larva	0.93	0.39	0.54	30.8	30.8	0.57

Notes:

If the succeeding crops are not defined, consider that the crops are attractive for both the pollen and nectar. In case that the application is before emergence of weeds then the shortcut values for weeds in the field and application before emergence can be used. However, it should be assessed whether the application before emergence of weeds is realistic and that it is clearly described in the GAP how to ensure that weeds are not emerged at the time of application.

Please note that the shortcut values for adjacent crops are independent from the application method. The shortcut values for the adjacent crop can be found in table Jyy.

\*: not applicable as the pollen consumption of forager HB is negligible. For a risk assessment for adult HB, the SV for nurse should be used.

**Table Jyy:** SV table for granules applied after emergence (broadcast application). The original tables J4, J6 and J7 can be found in [Appendix J](#).

Scenario	Treated crop and adjacent crop		
Category	SV ( $\mu\text{g}$ )		
	Crop attractive for pollen and nectar	Crop attractive for pollen, only	Crop attractive for nectar, only
HB forager acute	7.6	N/A*	7.6
HB forager chronic	5.8		5.8
HB nurse	3.8	0.92	3.0
HB larva	4.4	0.15	4.3
BB adult acute	11.2	2.3	9.4
BB adult chronic	9.9		8.1
BB larva	4.5	3.0	1.7
SB adult	5.7	0.78	5.2
SB larva	33.6	29.9	5.8

**Table Jyy:** SV table for granules applied after emergence (broadcast application). The original tables J4, J6 and J7 can be found in [Appendix J](#).

Scenario	Succeeding crop or Permanent crop next year			Weeds in the field (after emergence of weeds) + plants in field margins	Weeds in the field (before emergence of weeds)
	SV (µg)			SV(µg)	SV(µg)
Category	Crop attractive for pollen and nectar	Crop attractive for pollen, only	Crop attractive for nectar, only	Plants attractive for pollen and nectar	Plants attractive for pollen and nectar
	HB forager acute	0.70	N/A*	0.70	3.7
HB forager chronic	0.54	0.54		2.9	0.27
HB nurse	0.29	0.012	0.28	2.1	0.15
HB larva	0.40	0.002	0.40	2.2	0.20
BB adult acute	0.90	0.03	0.87	6.5	0.46
BB adult chronic	0.78		0.75	5.9	0.40
BB larva	0.20	0.04	0.16	2.6	0.11
SB adult	0.49	0.01	0.48	2.3	0.17
SB larva	0.93	0.39	0.54	30.8	0.57

Note: if the adjacent crops or the succeeding crops are not defined, consider that the crops are attractive for both pollen and nectar. In case that the application is before emergence of weeds then the shortcut values for weeds in the field and application before emergence can be used. However, it should be assessed whether the application before emergence of weeds is realistic and that it is clearly described in the GAP how to ensure that weeds are not emerged at the time of application.

\*: not applicable as the pollen consumption of forager HB is negligible. For a risk assessment for adult HB, the SV for nurse should be used.

### 3.4. Risk assessment for accumulative effects

In order to test for accumulative effects a study has to be carried out with two treatment groups. One group should be exposed to a concentration equal to the 48 h LC<sub>50</sub> (e.g. derived from the 10-d chronic study) and the second concentration should be one quarter of the 48h LC<sub>50</sub>. The study design should be similar to the 10-d chronic LC<sub>50</sub> study as proposed in the GD. The test measures the uptake of active substance until 50% mortality is reached (after about 2 days in the high concentration and after about 8 days in the low concentration). Assuming that equivalent toxic load produces the same level of mortality then the amount of active substance taken up should be the same in both treatment groups.

If the overall amount of active substance taken up in the low concentration group is greater than in the high concentration group than this an indication of fast elimination and metabolism of the substance and hence no concern of accumulative effects.

If, however bees in the low concentration reach 50% mortality at a lower dose than in the high concentration group then this is an indication of accumulative effects i.e. the effect is enforced by exposure time. The difference should be statistically significant with a confidence level of  $p=0.05$ . If the result reveals a non-statistically significant difference than it needs to be proven that it was possible with the test design to detect a 35% difference with a power of 80%.

In addition it needs to be determined if the half life in the animal is  $\leq 1$  day. To do that calculate the proportion of reference intake (EQL/EQH) and read the half life in Firgure O3.

In case that a substance has accumulative properties then proceed to 3.7. [Higher tier risk assessment](#).

For details on the accumulative assessment see [Appendix O](#).

### 3.5. Assessment of risk from exposure to contaminated water

All bees need water for their metabolism (Nicolson, 2009); however, at the moment it is not possible to quantify the level of exposure for non-*Apis* bees. Moreover, the very high level of water fluxes in honey bees at the colony level should be sufficiently protective for bumble bees and solitary bees. For these reasons, it is proposed to focus the risk assessment for contaminated water on honey bees only.

#### 3.5.1. Assessment of risk from exposure to guttation water

From the available literature and regulatory studies (see also EFSA Panel on Plant Protection Products and their Residues (PPR) (2012a)) effects on bees were observed from exposure to guttation droplets under the following conditions:

1. residues of a highly bee-toxic substance in guttation droplets;
2. high water demand of the bee colony;
3. bee colony close to the field where guttation occurs;
4. no alternative sources of water.

Guttation tends to occur more frequently under high soil moisture and high air humidity. In some crops, such as onions, carrots and sugar beet, guttation (JKI<sup>13</sup> personal communication) is rarely observed, while in others (e.g. maize) guttation occurs frequently. It is not possible on the basis of the available information to rule out exposure to guttation droplets from certain crops or under certain conditions and therefore this, along with potentially high residues, means that the assessment has to currently be conducted for all crops and uses. The risk assessment for the treated crop is worst case

---

<sup>13</sup> Julius Kühn-Institut, Germany.

and the risk from other plants is considered to be covered (e.g. weeds or adjacent crops). Further work should be conducted to identify crops for which exposure to residues in guttation droplets is not relevant. It would also be beneficial to compare different regions in Europe.

Guttation water occurring in treated crops may contain very high pesticide concentrations (EFSA Panel on Plant Protection Products and their Residues (PPR), 2012a), Appendix H). Therefore, the following risk assessment is proposed. It is possible that guttation water of plants other than the treated crop may contain the applied substance (e.g. weeds in the treated field, plants in field margins, adjacent crops, succeeding crops). These other plants are not covered in the scheme below as the risk for the treated crop will pose a greater risk than these other plants.

The screening is based on several worst-case assumptions such as the highest water consumption rate observed in literature at 35°C (Free and Spencer-Booth, 1958) and maximum water solubility as the concentration in guttation droplets. It is considered not necessary to include contact exposure in the screening because the screening step for oral uptake is based on worst-case assumptions and will identify highly bee-toxic substances for higher tier assessments. In higher tier studies, bees will be exposed by oral uptake and contact exposure. Potential effects on other life stages (larvae) will also be assessed in the higher tier studies.

Outlined below is a risk assessment scheme aimed at assessing the risk to honey bees from the consumption of guttation fluid. The lower tiers of the scheme simply assume that guttation fluid contains the active substance at a proportion of the water solubility and that honey bees take and consume it as water. The scheme also assumes that foragers collect guttation fluid and take it to the colony, where it is incorporated into brood food (e.g. royal jelly) and then fed to larvae.

The first part of the scheme assumes that crops produce guttation fluid, forager honey bees collect and consume guttation fluid and that guttation fluid is fed indirectly via brood food to larvae. Whilst these assumptions are true, the extent to which they occur is unknown and hence this leads to uncertainties in the scheme. The assessment has to be conducted for all active substances and application methods.

The uncertainties include the following:

1. The degree to which guttation occurs. The scheme, as presented, assumes that guttation occurs in every crop albeit within the guttation period. The scheme does not currently specifically consider the likely occurrence of guttation; for example, does it occur all of the time in all crops that are treated or in only a percentage of treated crops? (Please note that this issue is covered in the exposure flow chart (box 2); however, it is a generic issue and hence appropriate to all uses.)
2. The degree to which honey bees forage guttation fluid. The scheme assumes in the lower tiers that honey bees will forage on and collect/consume guttation fluid. The scheme considers that honey bees may not forage on guttation fluid and may collect/consume water from other sources in preference only in the highest tier (field study).
3. The use of guttation fluid in royal jelly and other brood food. The scheme assumes that guttation fluid is used in brood food. It is unknown to what extent this may occur.

All of the above points mean that the initial tiers of the scheme are precautionary and hence are likely to result in many failures and the need for higher tier studies. Guidance is provided regarding how to carry out higher tier exposure and effect studies. However, it is uncertain as to how practical these are; for example, there is a lack of experience to indicate the precise environmental conditions required to ensure that guttation occurs and that the concentration in the fluid is appropriate (i.e. equivalent to a 90th percentile). This issue is addressed by requesting five studies for seed treatments, whereas for spray applications two studies are recommended.

The above points indicate that further information is required to make the following scheme more robust. Further information is required on the following:

4. likely occurrence of guttation in terms of crop/calendar year combinations (see box 2 of the flow charts);
5. likely use of guttation fluid by honey bees, including the likelihood that it will be fed via brood food to larvae.

**The sequence for the risk assessment is the following:**

(Please see text below, “Exposure assessment and risk assessment flow chart”, for further details on each of the points).

Please note that calculated ETR and HQ values should always be reported to one more additional decimal place than the trigger value.

**1. Check whether exposure is negligible.**

If exposure is concluded to be negligible then a low risk to bees from guttation can be concluded.

**2. Check whether guttation occurs for < 10% of location/calendar year combinations.**

If it is less than 10%, then the exposure is considered as negligible; otherwise go to point 3. If no data are available then also go to point 3.

**3. Calculate the ETR for adult and larvae consuming guttation water based on conservative assumptions.**

**The ETR values for adult bees are calculated as follows:**

Acute oral adult LD<sub>50</sub> (OECD 213, 1998)

$$ETR_{acute} = W * PEC / LD_{50} \quad (1)$$

where W = 11.4 µL/bee per day and is the uptake of adult bees. Where the PEC is the concentration in the guttation water in µg/µL and is assumed to be 100% of the water solubility for the acute risk assessment in the first tier (see [Appendix T](#)). The LD<sub>50</sub> is the oral LD<sub>50</sub> in µg per adult bee.

Chronic adult (10-day LC<sub>50</sub>)

$$ETR_{chronic} = W * PEC / LC_{50} \quad (2)$$

Development of hypopharyngeal glands (HPGs) (NOEC 10-day LC<sub>50</sub>)

$$ETR_{hpg} = W * PEC / LC_{50} \quad (3)$$

where W = 11.4 µL/bee and is the uptake of adult bees and PEC is the concentration in the guttation water in µg/µL and is assumed to be 54% of the water solubility for the chronic risk assessment in first tier (see [Appendix T](#)). The LC<sub>50</sub> is the LC<sub>50</sub> (in µg/bee per day) based on an exposure period of 10 days. The NOEC on effects on development of hypopharyngeal glands is expressed in µg/bee per day and based on an exposure period of 10 days (see [Appendix O](#) for details).

**The ETR for larvae is calculated as follows:**

$$ETR_{chronic} = W * PEC / NOEC \quad (4)$$

where W is 111 µL for larvae (consumed over five days). The PEC is the time-weighted average concentration in the guttation water in µg/µL over five days. The PEC used in the initial risk

assessment is 72% of the water solubility (see [Appendix T](#)). The NOEC (in µg per bee) is based on an exposure period of five days (duration of exposure to water from oral uptake in the test is five days).

In the above scheme the PECs are based on using water solubility of 100% for the acute assessment, 54% of water solubility for the chronic PEC for adults and 72% of water solubility for the chronic PEC for larvae, for seed treatments, spray applications and granules (see [Appendix T](#)).

**The calculated ETRs should be compared with the acute ETR trigger of 0.2, the chronic ETR trigger of 0.03, the ETR (HPG) of 1 and the larval ETR trigger of 0.2** (for details on the trigger value see [Appendix M](#)).

If the ETR value is smaller or equal to the trigger, then the protection goal is met and go to 3.8. [Assessment of uncertainty and finalisation of the risk assessment](#); otherwise proceed in the risk assessment. Before conducting higher tier studies it is an option to refine the exposure estimate as outlined under point 4 (see also Risk assessment and exposure flow chart below).

#### 4. Refinement of the exposure calculation

The exposure estimate can be refined with residues measured in the crop of concern (see Figure 1). The PEC guttation needs to cover the 90<sup>th</sup> percentile in guttation fluid for the crop of concern. The location, growth stage and environmental conditions need to be considered.

For the chronic assessment of adult bees the peak concentration should be used unless there is information which could justify the use of a 10 day twa PEC (EFSA: evidence of no long-term effects after short-term exposure including time to onset of effects and decline of compound in guttation fluid can be used to prove that the twa approach is appropriate).

For spray and granular applications it is proposed to use the PEC pore water scenarios as a first refined approximation of the concentration in guttation fluid (90<sup>th</sup> percentile scenarios for the three regulatory zones are available (see EFSA Panel on Plant Protection Products and their Residues (PPR), 2012b).

For seed treatments it is proposed to refine the exposure estimate by conducting field studies and to measure the concentrations in guttation water.

Using these exposure data, the above ETR should be recalculated.

**5. The calculated ETRs should be compared with the acute ETR trigger of 0.2, the chronic ETR trigger of 0.03, the ETR (HPG) of 1 and the larval ETR trigger of 0.2** (for details on the trigger value see [Appendix M](#)).

The protection goal is met if the ETR value is smaller than the trigger values; if not, proceed with field studies. For details see [Appendix U](#).

#### Exposure assessment and risk assessment flow chart:

The first step in the flow chart is to check whether the substance is applied after the guttation period (**box 1**). If this is the case, there is no exposure.

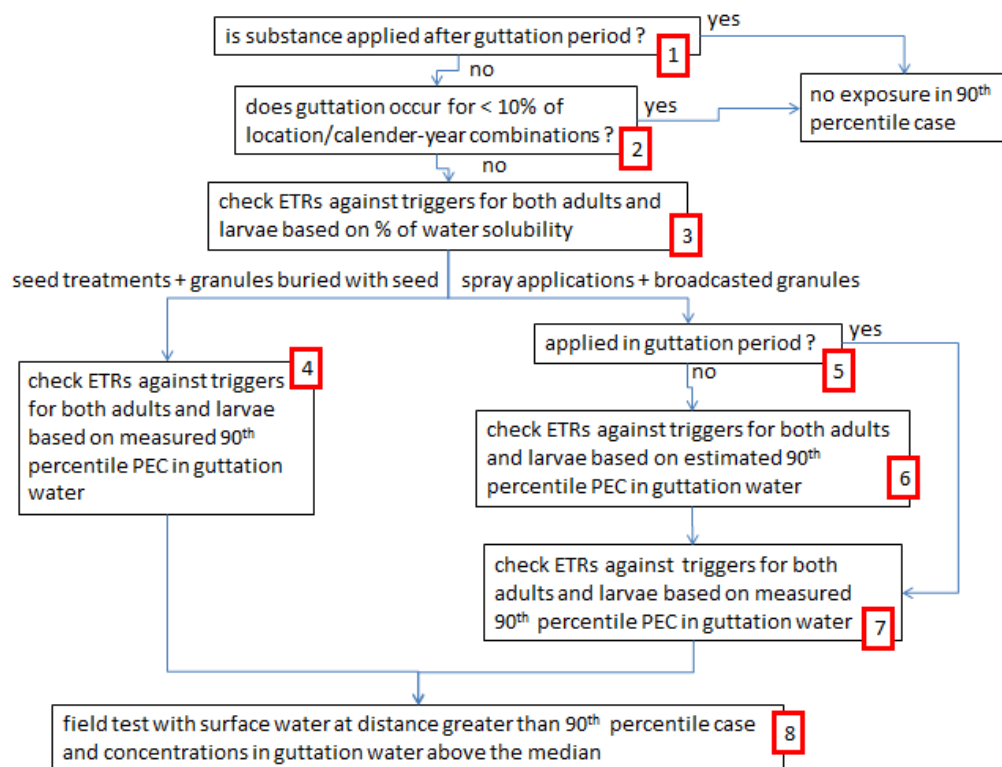
In **box 2** it is checked whether guttation water occurs for less than 10% of the location/calendar year combinations. If so, there is unlikely to be exposure for the 90<sup>th</sup> percentile case.

The following hypothetical example should illustrate the approach. Assume that the area of use of the substance consists of 1000 fields grown with this crop and consider a time series of 10 years for the assessment of occurrence of guttation water. Assume that we can assess whether or not any guttation occurs for this crop in a calendar year when grown on these 1000 locations in these 10 years (e.g. via

some simulation model). It could then be checked whether any guttation occurs for less than 10% of these  $10 \times 1000 = 10000$  cases. If this were the case, the conclusion is that there will be no exposure to guttation water in the 90<sup>th</sup> percentile case (considering the statistical population of colonies at the edge of treated fields as the exposure assessment goal as described in [chapter 2](#)).

It may be possible to include information on the daily temperature in determining whether exposure to guttation water may occur as it is well known that bees forage for nectar and pollen usually only above 12 C. The foraging activity of honey bees is low at ambient temperatures below 12–14°C (Kevan and Baker, 1983; Winston, 1987).

However, this threshold does not apply to water foraging, i.e. collection for water occurs at temperatures less than 12°C. Therefore, it is probably not feasible to refine the risk assessment based on air temperature. At this moment, there is no detailed guidance for box 2. So it will be usually necessary to proceed with the next step (**box 3**) and calculate the acute and chronic ETR.



**Figure 1:** Flow chart for the assessment of the risk resulting from guttation water. The numbers of the boxes are used in the text for their identification

After **box 3**, the flow chart has two branches: one for the seed treatments and the granules buried with the seed (left) and one for the spray and broadcasted granule applications. For the seed treatments and the granules buried with the seed, the next step is to refine the exposure by field measurements on five locations to assess the 90th percentile PEC in guttation water (**box 4**).

The assessment for the spray and broadcasted granule applications starts with the check whether the substance is applied in the guttation period (**box 5**). If not, the percentage water solubility is replaced with an estimated 90th percentile concentration in guttation water (**box 6**).

The EFSA Panel on Plant Protection Products and their Residues (PPR) (2012b) developed a tiered approach for assessing 90<sup>th</sup> percentile pore water concentrations in the top layer of soil for annual crops under conventional and reduced tillage (assuming ploughing over 20 cm every year). Scenarios were selected for the three regulatory zones (south–centre–north) for simulations with numerical

models. These models calculate uptake of substances by the crop assuming passive uptake based on the concept of the transpiration stream concentration factor (TSCF). This concept assumes that the concentration of substance in the transpiration stream of the plant is a constant fraction (i.e. this TSCF) of the concentration in the water that is taken up by the plants. It is proposed to use these scenarios in combination with a TSCF of 1 and to assume that the concentration in the guttation water is equal to the concentration in the transpiration stream of the plant. Because this approach has so far not been tested, it is proposed to multiply simulated peak concentrations in the transpiration stream with a model uncertainty factor. Uncertainties are also related to the concentration of the compound in the guttation droplet compared with the transpiration stream. As a starting point, an uncertainty factor of 5 is suggested. Once such tests for a range of conditions and substances have become available and have shown that the approach is conservative enough, this model uncertainty factor may be lowered. For systems other than annual crops under conventional or reduced tillage, no pore water scenarios are available. So these cannot be dealt with in this tier and have to be referred to higher tiers.

If the simulations with the numerical models do not result in acceptable risk, the next step is to perform field experiments to assess the 90<sup>th</sup> percentile concentration in the guttation water (**box 7**). Residue measurements should aim at measuring the decline of the concentrations in guttation water with time accurately, starting at the first occurrence of guttation after application and a sampling frequency that decreases with time.

For the applications in the guttation period, this can be done by performing five field experiments and taking the highest PEC resulting from these five experiments. For spray and broadcasted granule applications that get into box 7 via box 6, these have to be targeted to the 90<sup>th</sup> percentile combination of soil and weather conditions based on the EFSA pore water scenarios used in the simulations. This is likely to lead to the requirement that the field study has to be carried out in a soil with low organic matter content and at a location with a relatively low temperature (see EFSA Panel on Plant Protection Products and their Residues (PPR) (2012b)). It may be useful to use the databases used by EFSA Panel on Plant Protection Products and their Residues (PPR) (2012b) for the selection of the location (see <http://eusoils.jrc.ec.europa.eu/library/Data/EFSA/>). As described before the EFSA Panel on Plant Protection Products and their Residues (PPR) (2012b) only considered annual crops under conventional or reduced tillage. For the other systems (e.g. permanent crops) it is proposed to base the 90<sup>th</sup> percentile conditions on the assumption that these occur under conditions of a combination of a low organic matter content and a relatively low temperature in the area of use of the substance. It is proposed to perform at least two experiments in the area of use of the substance targeted to measure concentrations for 90<sup>th</sup> percentile cases.

From these experiments both the peak concentration and the 5- and 10-day twa concentrations could be derived (note that this has the consequence that the 90<sup>th</sup> percentile peak and the 90<sup>th</sup> percentile twa concentration may be based on different experiments). The 10-day twa can be used to refine the exposure assessment for the adults provided that the use of a twa is justified (e.g. evidence of no long-term effects after short-term exposure including time to onset of effects and decline of compound in guttation fluid can be used to proof that the twa approach is appropriate)

If all these steps have not demonstrated that the SPGs are achieved, the conclusion has to be that guttation water, if used as the only water source, is likely to lead to unacceptable effects. However, if given the choice, bees prefer permanent water sources (streams, ditches, ponds, rivers) over temporary water sources like guttating plants. So, in the presence of such permanent water sources high concentrations in the guttation water are unlikely to lead to adverse effects in the hive. Therefore, in **box 8** field studies are proposed under 90<sup>th</sup> percentile worst-case conditions with respect to the presence of permanent water sources both for seed treatments and spray and granule applications. This means that the assessment moves to the landscape level and the main driver for the effect assessment then becomes the distance of the hive to the nearest water source. Therefore, it is proposed to conduct field studies in which the distance to the nearest permanent water source is equal to or larger than the 90<sup>th</sup> percentile case in the area of use of the substance.

These distances can be assessed via global information system (GIS) procedures. The concentrations in the guttation water are expected to play only a minor role at this level of the risk assessment. Therefore, it suffices if the concentrations in the guttation water are above the median case for the area of use of the substance. In these field studies both the concentrations in the guttation water and the effects on the beehive have to be assessed. The selection of the soil and meteorological conditions for these field studies can for the spray and broadcasted granule applications that are not applied in the guttation period be selected based on the EFSA pore water scenarios used in **box 6**. For the seed treatments the selection can be based on the field experiments performed in **box 4**. For the number of fields/replicates to achieve a sufficient power to detect effects, please see chapter 4.

### **Risk mitigation for exposure to guttation**

From the available information it is evident that effects on bees from exposure to guttation water were observed only when no alternative sources of water were in the vicinity of the hive. The provision of water could mitigate the risk.

The distance of the colony to the field where guttation occurs is also of importance. Guttation was observed very frequently in grasses and in the vegetation outside of the field. Such vegetation could be more attractive for bees to collect guttation water than the crop plants. Furthermore, the available data suggest that bees prefer permanent water sources to guttation droplets. Therefore, a vegetated buffer strip and permanent water bodies in the vicinity of the field could mitigate the risk from guttation water. It could be an option to restrict uses (planting of seed treated crops) to fields where permanent water bodies such as ponds or streams are in the close vicinity. However, the available information is not sufficient to give an exact recommendation on the minimum distance to the next permanent water body that is needed to avoid that bees use guttation droplets from treated fields. Research would be needed to investigate the distance at which permanent sources of water are preferred over guttation droplets collected in the field.

In principle it would also be possible to develop a tier based on a landscape-level approach for guttation water considering all the other guttating plants in the foraging area, e.g. based on a criterion that less than a specified percentage of the water foragers will collect contaminated guttation water. However, current knowledge seems insufficient to develop such an approach.

Another option is to provide the bee colonies with an alternative water source. This should be considered at MS level. At this moment it is not yet clear whether this is acceptable across the EU.

Overall, it is concluded that more information is needed to decide on the efficiency of different risk mitigation options.

### **3.5.2. Assessment of risk from exposure to surface water**

As bees will drink from surface water present in the agricultural environment, it is proposed to consider the possible effects of consumption of surface water by bees. In the first instance, it is proposed to base this on checking whether the triggers for the acute and chronic adult ETR and larvae ETR are met as calculated with Eqns 1, 2, 3 and 4 from the assessment of exposure to guttation water above using again a daily water consumption  $W$  of 11.4  $\mu\text{L}$  for adult bees and 111  $\mu\text{L}$  (five days) for larvae.

As regards the PEC, it is suggested to use the initial PEC in surface water as calculated by FOCUS. It is also possible to use directly the regulatory acceptable concentration (RAC) from the aquatic risk assessment if the RAC is available from higher tier aquatic risk assessments.

**The calculated ETRs should be compared with the acute ETR trigger of 0.2, the chronic ETR trigger of 0.03, the ETR (HPG) of 1 and the larval ETR trigger of 0.2 (for details on the trigger value see [Appendix M](#)).**

The protection goal is achieved if the calculated ETR values are smaller or equal to the trigger values and it can be proceeded with 3.8. [Assessment of uncertainty and finalisation of risk assessment](#).

It is expected that the RAC from the aquatic risk assessment is low enough that it will not lead to any effects on bees drinking from surface water. Only in case of substances which are particularly toxic to bees compared with aquatic arthropods (crustaceans and insects) could there be a risk to bees. In such cases a potential risk would be indicated by the first tier calculation above.

If the triggers are not met, the exposure in surface water can be mitigated following the procedures described by FOCUS (FOCUS, 2001, 2007b, a). Please note that this does not imply acceptance of these FOCUS procedures by EFSA because EFSA never reviewed FOCUS (2001) which formed the basis for FOCUS (2007b); (FOCUS, 2007a).

### 3.5.3. Assessment of risk from exposure to water in puddles

Bees may also consume water from puddles; in fact, there is some evidence to indicate that they even seem to prefer puddle water over water from streams and ditches. EFSA Panel on Plant Protection Products and their Residues PPR Panel (2012a, p. 218) reviewed the assessment of the concentrations in puddle water by EFSA (2008b) and concluded that it may not be sufficiently conservative. EFSA Panel on Plant Protection Products and their Residues (PPR) (2012b) recommended that the concentrations in the puddle water are estimated from the concentrations in the runoff water from the FOCUS runoff scenarios (R1, R2, R3, R4; see FOCUS, 2001) relevant for the use.

It is proposed to check as a first tier whether the triggers for the acute and chronic ETR for adult and the ETR for larvae are met as calculated with Eqns 1, 2, 3 and 4 from the assessment of exposure to guttation water using, again a daily water consumption  $W$  of 11.4  $\mu\text{L}/\text{bee}$  and 111  $\mu\text{L}/\text{larvae}$  (5-day larvae) using the concentrations in the runoff water from the four FOCUS runoff scenarios<sup>14</sup>. The peak concentration of each of the relevant R1–R4 scenarios should be calculated and the highest value should be taken. The justification for this conservative approach is that EFSA has not yet evaluated the appropriateness of these FOCUS scenarios. Please note that FOCUS (2001) provided guidance for running these scenarios only for spray applications; guidance for running them for seed treatments and granules can be found in EFSA (2004).

**The calculated ETRs should be compared with the acute ETR trigger of 0.2, the chronic ETR trigger of 0.03, the ETR (HPG) of 1 and the larval ETR trigger of 0.2** (for details on the trigger value see [Appendix M](#)).

The protection goal is achieved if the calculated ETR values are smaller or equal to the trigger values and it can be proceeded with 3.8. [Assessment of uncertainty and finalisation of risk assessment](#).

The concentrations in the runoff water of the R1–R4 scenarios may be considerably higher than the concentrations in the surface water of these scenarios. This is because FOCUS (2001) assumes that only 20% of the upstream catchment of the stream is treated with the substance and that concentrations from runoff events generate small water volumes that may then be strongly diluted in the streams. Moreover, the normal risk mitigation measure used for surface water (runoff reduction by buffer strips) is not relevant for the consumption of puddle water by the bees. It is therefore desirable to develop a probabilistic higher tier approach for the concentration in puddle water that is targeted at the 90<sup>th</sup> percentile worst-case exposure for the hives at edges of treated fields in the area of use of the substance. This approach has to combine the likelihood of occurrence of puddles in the treated fields in the first months after application of the substance with the concentrations in the puddle water. However, the development of such an approach was not possible within the time frame of the writing

---

<sup>14</sup> This assessment differs from the birds and mammals Guidance Document. It is proposed that the assessment of oral exposure from puddle water in the birds and mammals Guidance Document is revised when the birds and mammals Guidance Document is updated.

of this Guidance Document as it would require a considerable amount of work and expertise in the field of soil physics, which was not available to the workgroup

### 3.6. Risk assessment scheme for metabolites

Sinclair (2009) investigated the toxicity of metabolites in relation to the parent compound of several PPPs (60 a.s. and 485 transformation products) to aquatic organisms and demonstrated that the majority (70%) of transformation products either have a similar toxicity to the parent compound or are less toxic. However, a significant proportion (30%) were more toxic than their parent compound and 4.2% of transformation products were more than an order of magnitude more toxic. Over 90% of the observed increases in toxicity of the metabolite could be explained by the presence of a toxophore, differences in accumulation (i.e. hydrophobicity) or differences in mode of action (for example active components of pro-PPP or highly reactive metabolites). Furthermore, the investigation showed that a transformation product that is more hydrophobic than its parent compound and does not have pesticidal activity is unlikely to be more toxic than its parent to sensitive species that have a receptor site relevant to the parent mode of action. This information is integrated in the risk assessment scheme below.

The proposed scheme does not assess the potential risk from metabolites that may be formed in the soil and occur in guttation fluid, or formed in water or honeydew. When drafting the scheme it was decided to focus on metabolites that may occur in pollen and nectar as these will be the major exposure routes. Depending upon the design of the plant metabolism study may mean that metabolites present in the soil and subsequently taken up by the plant *may* not be covered. If the plant metabolism study includes exposure of the soil, then this route *may* be covered. Similarly, if the study is designed to assess metabolism in following crops, then soil metabolites *may* be addressed. Further work is required to develop a scheme that covers all potential metabolites.

As a starting point the information from plant metabolism studies is used. These studies are designed to identify metabolites at usually one point in time. Each metabolite exceeding 10% (total radioactive residues or TRRs) or 0.01 mg/kg is identified in the plant metabolism study. These studies do not necessarily cover the flowering of the crop. In the following scheme, the metabolism in the crop is extrapolated to other plants, e.g. adjacent crops or weeds. This leads to uncertainties in the assessment, but in the absence of other data it is proposed to use the plant metabolism studies in the first tier.

If a well-designed field effect study is conducted and the presence of metabolites was confirmed then the risk to metabolites is considered to be covered and no separate assessment for the metabolites needs to be performed.

The assessment of the risk from oral uptake of metabolites in pollen and nectar needs to be assessed for honey bees, bumble bees and solitary bees.

1. Identify plant metabolites from plant metabolism studies in which the parent substance is applied in the same way as for the intended use. For the following crops this should include application to bare soil. Please note that if data on occurrence of metabolites in pollen and nectar are available, then the assessment should focus on these metabolites and it is not necessary to test other plant metabolites identified in the plant metabolism studies. Are there any identified metabolites formed in amounts of > 10% (TRR) or 0.01 mg/kg?

**Yes: Go to 2.**

**No: No further assessment is required.**

2. Is it clear that the toxophore relevant for the toxicity to bees has been lost from the molecule (see Note 1)?

**Yes: No further assessment is required.**  
**No or unclear: Go to 3.**

- Calculate the acute and chronic ETR values based on 10 times higher toxicity than the parent compound. Multiply the shortcut value for the parent compound with the maximum percentage of the metabolite (TRR) observed in plant metabolism studies in any matrix analysed (except roots) to estimate the exposure. The following equations should be used:

$$\text{EXPmet} = \text{Ftrr} \times \text{M}(\text{met})/\text{M}(\text{par}) \times \text{SVpar} \times \text{AR} \text{ (application rate)}$$

EXPmet = Exposure to metabolite

Ftrr = fraction of metabolite formed

M(met) = molar mass of the metabolite

M(par) = molar mass of the parent molecule

SV(par) = shortcut value for the parent molecule

AR = application rate of the parent molecule (the application rate should be expressed in the same units as in the assessment of the parent compound, i.e. kg/ha for all types of applications and scenarios except the treated crop scenario for seed treatments where the unit is mg/seed)

The ETR values need to be calculated for adult (acute and long-term) and larvae as outlined in the risk assessment schemes for the parent compound.

Please note that the shortcut value and the application rate are already included in the EXPmet and hence double counting needs to be avoided in the ETR calculation (replace the AR and SV by EXPmet in the ETR equation).

Example:

ETRchronic adult for parent compound:  $\text{ETR}_{\text{chronic}} = \text{AR} \cdot \text{Ef} \cdot \text{SV} \cdot \text{twa} / 10\text{d LDD}_{50}$

ETRchronic adult for the metabolite:  $\text{ETR}_{\text{chronic}} = \text{EXPmet} \cdot \text{Ef} \cdot \text{twa} / 10\text{d LDD}_{50}$

**The calculated ETRs should be compared with the acute ETR trigger of 0.2 (Bumble bee trigger = 0.036, Solitary bee trigger = 0.04), the chronic ETR trigger of 0.03 (Bumble bee trigger = 0.0048, Solitary bee trigger = 0.0054), the ETR (HPG) of 1 and the larval ETR trigger of 0.2 (for details on the trigger value see [Appendix M](#)).**

Calculated first tier ETR values smaller than the trigger values?

**Yes: Go to 4.**

**No: No further assessment is required.**

- Determine the acute and chronic toxicity to adult bees and larvae specific for the metabolite (e.g. experimentally derived or QSAR) and calculate the first-tier ETRs (repeat the calculation in point 3 with the new endpoint). First tier ETR trigger values breached?

**Yes: Consider higher tier refinement.**

**No: No further assessment is required.**

#### **Note 1: Identification of toxophore**

Substances that have a specific mode of action, such as pesticides, contain a structural feature or moiety that gives the toxic property. This structural feature is referred as the toxophore, or toxophoric moiety. The substance causes toxicity through the interaction of its toxophore with a biomolecular site

(e.g. receptor). Substances that are structurally similar could contain the same toxophore (or may yield a common toxophore upon metabolism) and may therefore have a common toxic effect.

For the assessment of the metabolite it may be possible for the applicant to provide a reasoned case as to whether the molecule contains a toxophore or it has been lost following transformation. Toxophores for each of the major classes of PPPs have been identified by looking for substructural similarities within a pesticidal class by Sinclair (2009), which can be used to support argumentation. A number of ways have been identified to define domain of applicability, which may be used to decide whether or not toxophores are present (Dimitrov et al., 2005; Jaworska, 2005; Netzeva, 2005; Nikolova and Jaworska, 2005). If cannot be clearly shown that the toxophore is not present in the molecule, it should be assumed that the toxophore remains and that the molecule has a specific mode of action.

### **3.6.1. Alternative information replacing experimental studies**

The principles for assessing metabolites should in essence be the same as those for active substances. However, in contrast to the active substance, data requirements for metabolites do not always have to be addressed by experimental studies. Applicants are invited to address the open questions by any other available information in support of a scientific and rational assessment. If chemical analysis confirms that the metabolite was present in the pollen and nectar of the original test (e.g. field study), then it can be concluded that the risk from the metabolite is addressed by this study providing that exposure of foragers to the required concentration has been achieved. Furthermore, for this extrapolation to be valid it is also important that the time period after the measured metabolite concentration was of sufficient length for observation of effects. The appropriateness of the concentration of a metabolite, as well as the duration of exposure, should be regarded in relation with metabolism studies in plants (reference should be made to studies provided in the residue section).

### **3.6.2. Toxicity testing with metabolites**

For metabolites which require experimental studies, the same testing scheme as for active substances is generally required except an acute contact study. The acute contact study with metabolites is not required because exposure to metabolites will be predominantly via oral route. As regards the issue of accumulative toxicity, if the active substance is considered to fail the Haber's law test, then it is assumed that the metabolite(s) will as well. This is accepted as being the worst case. In this situation, when the risk from the active substance is refined, it is important to consider the risk from the metabolite(s) as well.

### **3.6.3. Refined risk assessment for metabolites**

In principle, the risk assessment process for metabolites will be similar to that for active substances, albeit recognising that risk assessment cases will not always require specific study data for certain metabolites. If preliminary risk assessments indicate potential concerns then, as for parent molecules, risk refinement is possible either by refining effect concentrations or by refinement of the exposure concentration.

If higher tier studies have been conducted with the active substance, or a relevant formulation, these studies may have also assessed the risk from the metabolites. It is advised that if a higher tier study, e.g. field study, is being carried out then appropriate analysis should be conducted so that an assessment of both the exposure and effects of any metabolites can be made. If the metabolites are of lower toxicity than the parent, then the risk from the metabolites is considered to be covered in the field study with the parent compound and confirmation of presence of these metabolites can be waived.

### 3.7. Higher tier risk assessment

If concern is raised at the first tier, i.e. a HQ or ETR is breached or the active substance indicates the potential for accumulative effects, then refinement is required. If as a result of the risk assessment for accumulative toxicity concern has been raised, then higher tier studies are required, for example field studies.

No stepwise approach is offered in this guidance document (see introduction to this chapter).

It may be possible to find a safe use by introducing risk mitigation measures or it may be appropriate to further refine the exposure estimate and use these data in a refined risk assessment, i.e. replace the default values with crop/compound specific values (i.e. see [Appendix N](#) and [Appendix S](#)). It may, alternatively be appropriate to carry out a field effects study (see Appendices [O](#), [P](#), [Q](#) and [U](#)).

If any HQ or ETRs are breached, before planning effects field studies, it is recommended to investigate first possibilities to refine the exposure estimates. For example, for oral route of exposure (pollen and nectar) the actual residue levels of the active substance can be determined in pollen and nectar (see [Appendix G](#)) and these data can be considered in a refined SV (a refined Monte-Carlo simulation will be necessary to obtain such a refined SV). This refinement is likely result in a considerably lower SV for the treated crop for those cases when the pesticide is used before the flowering of that crop. Also, properties such as low persistence or low potential for mobility in plants will likely result in lower residue levels in pollen and nectar. Other options may also be considered. For details on those options, the relevant chapters of the guidance document such as [Appendix H](#), [Appendix N](#), [Appendix G](#) or [Appendix S](#) needs to be consulted. Examples of such refinements (2<sup>nd</sup> tier options) are listed below. It needs to be noted that some of those options are relatively straightforward, while others (e.g. those which would require landscape analysis) may require considerable effort and no detailed guidance for them could be given in this document.

- Refine residue levels with measurements of pollen/nectar
- Refine twa factor with residue decline data (consult FOCUS, 2006)
- Refine nectar sugar content with field measurements
- Refine pollen consumption with laboratory/field measurements
- Refine dustiness of solid formulations (Heubach a.i.)
- Refine dust/spray deposition with field measurements
- Refine PECs for succeeding crops by pore water model
- Conduct exposure field studies (for contact exposure)
- Refine spray/dust drift with stochastic model
- Analyse coverage of weeds in the field
- Analyse coverage of attractive adjacent crops
- Analyse coverage of attractive succeeding crops

**Following the higher tier risk assessment, go to 3.8. [Assessment of uncertainty and finalization of the risk assessment.](#)**

### **3.8. Assessment of uncertainty and finalisation of the risk assessment**

Analyse uncertainties in the risk assessment as well as the underlying data to determine the uncertainty in the assessment and in particular whether the SPG will be met (see [chapter 4](#)). Summarise all data, associated risk quotients and uncertainties and conclude on the risk assessment. An analysis of underlying uncertainties is not necessary if the screening step or first tier assessments indicate that the specific protection goals are met.

## 4. Uncertainty analysis

### 4.1. Approaches for characterising uncertainty in higher tier assessments<sup>15</sup>

Regulation (EC) No 546/2011 lists in Annex I, Part I (Uniform principles for evaluation and authorisation of chemical plant protection products) general principles for the evaluation of information under point 1.4: *“In interpreting the results of evaluations, Member States shall take into consideration possible elements of uncertainty in the information obtained during the evaluation, in order to ensure that the chances of failing to detect adverse effects or of under-estimating their importance are reduced to a minimum. The decision-making process shall be examined to identify critical decision points or items of data for which uncertainties could lead to a false classification of risk.”* This implies that uncertainties in the data should be considered.

Regulation (EC) No 1107/2009 refers for decision-making to Annex VI of Directive 91/414.

Point 2.5.2.1 in Annex VI to Directive 91/414/EEC states that no authorisation shall be granted unless it is ‘clearly established’ that no unacceptable impact occurs. The term ‘clearly establish’ implies a requirement for some degree of certainty. First tier assessments use standardised scenarios and decision rules which are designed to provide an appropriate degree of certainty. Higher tier assessments are not standardised, and so the degree of certainty they provide has to be evaluated case by case. The need for risk assessments to include characterisation of uncertainty has also been emphasised at senior policy levels in the EU<sup>16</sup>, see also Stirling (2010).

Methods for characterising uncertainty can be grouped into three main types:

- Qualitative methods: using words to describe the certainty of an outcome, or to describe how different the true outcome might be compared with an estimate.
- Deterministic methods: generating deterministic quantitative estimates of impact for a range of possible scenarios. This shows the range of possible outcomes (e.g. a range of ETRs) and can be accompanied by qualitative descriptions of their relative probabilities (traditional ‘worst-case’ assessments are an example of this).
- Probabilistic methods: these give numeric estimates of the probabilities of different outcomes (Luttik, 2011). These probabilities may be estimated statistically (e.g. when quantifying measurement or sampling uncertainty, or as outputs from probabilistic modelling). However, they may also be estimated subjectively, by expert judgement.

All uncertainties affecting an assessment should be considered at least qualitatively. To reduce the risk of overlooking important uncertainties, it is recommended that each part of the assessment (e.g. different lines of evidence, different inputs to calculations, etc.) be systematically considered and all of the sources of uncertainty listed, together with a description of the magnitude and direction of their potential influence on the expected level of impact. As well as evaluating each individual source of uncertainty, it is also essential to give an indication of their combined effect. It is recommended that a tabular approach be used to facilitate and document this process, as illustrated in Tables 1 and 2. This is based on an approach used in some EFSA opinions (EFSA, 2005, 2007b, a, 2008a), but adapted to increase clarity by introducing separate columns to describe uncertainties that act in different directions.

<sup>15</sup> After paragraphs 6.8 and 6.9 of bird and mammal guidance document (EFSA, 2009).

<sup>16</sup> E.g. “Even though it is not a subject that lends itself easily to quantification, I would urge you to take account of the risk manager’s need to understand the level of uncertainty in your advice and to work towards a systematic approach to this problem.” (Madelin, 2004).

Research in social science has shown that there is a general tendency for experts to underestimate uncertainties. It is therefore important that risk assessors should be aware of the potential magnitude of common uncertainties in the assessment of risks to organisms. For example, assessors should be aware of the potential magnitude of measurement uncertainties (e.g. methods used for determining the number of dead bees (i.e. forager mortality) and of the potential magnitude of sampling uncertainty associated with small and moderate sized datasets).

In some cases, a qualitative evaluation of uncertainties may be sufficient to establish clearly (i.e. with sufficient certainty) that unacceptable levels of impact will not occur, as is required by the ‘unless’ clause in Annex VI<sup>17</sup>. In other cases, a purely qualitative evaluation of uncertainty may not give a sufficiently clear picture of the range of possible outcomes. In such cases, one option is to obtain additional data to reduce uncertainty. This may usefully be targeted on the uncertainties that appeared largest in the qualitative evaluation. However, an alternative option is to refine the characterisation of the uncertainties progressively, by evaluating some of them using first deterministic methods and then, if necessary, probabilistic methods. This implies a tiered approach to the treatment of uncertainties, which starts by evaluating all uncertainties qualitatively and progresses either by reducing uncertainty (by obtaining additional data) or by refining the evaluation of selected uncertainties (either deterministically or probabilistically), until the point at which it can be ‘clearly established’ whether an unacceptable impact will occur (as required by the ‘unless’ clause in Annex VI).

**Table 2:** Tabular approach recommended for qualitative evaluation of uncertainties in refined assessments. The +/- symbols indicate whether each source of uncertainty has the potential to make the true risk higher (+) or lower (–) than the outcome of the refined assessment. The number of symbols provides a subjective relative evaluation of the magnitude of the effect (e.g. +++ indicates an uncertainty that could make the true risk much higher). If the effect could vary over a range, lower and upper evaluations are given (e.g. +/-+). If possible, the user should indicate the meaning of different numbers of symbols (e.g. two symbols might be used to represent a factor of 5, and three symbols a factor of 10). See Appendix V. for some practical examples

Source of uncertainty	Potential to make true risk lower	Explanation	Potential to make true risk higher	Explanation
Concise description of first source of uncertainty	Degree of negative effect (e.g. --- –	Short narrative text explaining how this factor could make true risk lower		
Second source of uncertainty			Degree of positive effect (e.g. +++)	Short narrative text explaining how this factor could make true risk lower
Add extra rows as required for additional sources of uncertainty	–	Note: many uncertainties may act in both positive and negative directions	+	
Overall assessment	Narrative text describing the assessor’s subjective evaluation of the overall degree of uncertainty affecting the assessment outcome, taking account of all the uncertainties identified above. The overall assessment should be a balanced judgement and not simply a summation of the plus and minus symbols.			

It is unlikely that it will ever be practical—or necessary—to quantify all uncertainties, so every deterministic or probabilistic assessment should be accompanied by a qualitative evaluation of the unquantified uncertainties. Also, it should be remembered that deterministic and probabilistic methods

<sup>17</sup> Commission Regulation (EU) No 546/2011 of 10 June 2011 implementing Regulation (EC) No 1107/2009 of the European Parliament and of the Council as regards uniform principles for evaluation and authorisation of plant protection products.

often require assumptions (e.g. about distribution shapes) that are themselves uncertain, and these additional uncertainties should be included in the qualitative evaluation. Therefore, every refined assessment should contain at least a qualitative evaluation of uncertainties.

The overall magnitude of uncertainty associated with an assessment will often be very large. This should not be regarded as implying a failure of risk assessment; on the contrary, it provides essential information for decision-making (Madelin, 2004; Stirling, 2010).

It should be noted that for pesticides for which several different types of refined assessment are used, the uncertainties affecting each one will be different. In such cases it is recommended that the uncertainties affecting each approach be evaluated separately. The contribution of the multiple assessment approaches (multiple lines of evidence) in reducing overall uncertainty can then be evaluated by weight-of-evidence in the final risk characterisation (see next section).

Appendix V. provides some further information on the types of issues that should be considered when determining the uncertainty in higher tier studies. [Appendix V](#) also contains a brief worked example.

In summary, it is recommended that:

- Every refined risk assessment should be accompanied by at least a qualitative evaluation of the uncertainties affecting it, using a systematic tabular approach. In assessments with multiple lines of evidence, the uncertainties affecting each line of evidence should be evaluated separately.
- In cases where qualitative evaluation of uncertainty is not sufficient to determine whether it is clearly established that no unacceptable impact will occur, the assessor may either (a) seek further data to reduce the uncertainty or (b) refine the evaluation of the existing uncertainties using quantitative methods (which can be either deterministic or probabilistic).

#### **4.2. Risk characterisation and weight-of-evidence assessment**

Risk characterisation is the final step of risk assessment. At this point, all relevant information or evidence that has been gathered is used to produce an overall characterisation or description of the risk, in a form that is suitable for decision-making.

To be useful for decision-making, the risk characterisation should focus on evaluating whether the relevant protection goals are satisfied for the pesticide under assessment: the magnitude of effects on colonies should not exceed 7 % reduction in colony size and forager mortality should not be increased compared with controls by a factor of 1.5 for six days or a factor of 2 for three days or a factor of 3 for two days.

Often, risk characterisation will involve combining several different types of refined assessment, each providing a separate indication of the risk. For example, an applicant might submit a refined exposure assessment, together with some additional toxicity studies and/or a proposal for mitigation. These need to be integrated in an overall risk characterisation that takes appropriate account of each, so as to provide the best basis for decision-making. This process of combining available 'lines of evidence' to form an integrated conclusion or risk characterisation is frequently referred to as 'weight-of-evidence' assessment (e.g. EC (2002a); Hull and Swanson (2006)). This term reflects the principle that the contribution of each line of evidence should be considered in proportion to its weight.

It is recommended that the following approach is taken regarding a weight-of-evidence assessment:

- Consider all relevant lines of evidence, including the first tier assessment. Retention of the first tier assessment is appropriate in all cases, as it is relevant to consider whether it was borderline or failed by a large margin.

- Evaluate the uncertainties associated with each line of evidence. This should be done by applying the approaches described in the preceding section to each line of evidence separately. The characterisation of overall uncertainty for each line of evidence is then used in the weight-of-evidence assessment, as in principle the weight given to each line of evidence should be proportional to its certainty.
- Form overall conclusions by using expert judgement to combine all lines of evidence, weighted according to their certainty, and give more weight to the most certain, but also take due account of the less certain. High certainty implies high weight. If one line of evidence implies a much narrower range for the risk than another line of evidence (i.e. higher certainty), then the true risk is most likely to fall inside the range of the former.
- Be sure to take full account of the uncertainties and to include a fair description of the range of possible outcomes in the final risk characterisation. Identify the outcome that is considered most likely, but do not give it more emphasis than is justified by the evidence.
- If different lines of evidence conflict (e.g. a high ETR but no effects in a field study), this should be considered a form of uncertainty. No line of evidence should be completely discounted unless it is wholly invalid or irrelevant. Instead, as stated above, each line of evidence should contribute to the overall conclusion in proportion to its certainty.
- If the overall characterisation of risk is expressed qualitatively, choose words very carefully to describe the outcome and its uncertainty as clearly as possible. For example the phrase ‘on balance’ is often used to focus on one of several possible outcomes, e.g. “on balance, it is concluded there will be no mortality”. This type of statement is not appropriate, because it fails to communicate the degree of certainty (e.g. ‘on balance’ could mean 51 % certainty, or 99 %).<sup>18</sup>
- A weight-of-evidence assessment is inevitably subjective. Different assessors may vary in their weighing of the evidence, especially when uncertainty is high. Therefore, it is essential to document the assessment in detail, including the outcome and uncertainty for each lines of evidence considered, and to explain how they were combined to reach conclusions about the overall outcome and its uncertainty.

It is recommended that a systematic tabular approach to documenting the weight-of-evidence assessment, such as that illustrated in Table 2. The tabular format provides a concise yet clear summary of the lines of evidence considered and how they were combined. It also helps the reader to evaluate whether the assessment was balanced, and aids consistency of approach between pesticides.

It should be noted that Table 2 summarises the major types of uncertainty for each line of evidence, and not just the overall uncertainty. This is recommended because it helps the assessor to take account of some important strengths and weaknesses of different types of refined assessment (see, for instance, EFSA (2009)).

The subjectivity of weight-of-evidence assessment can impede the formation of an independent view when this is based on the assessment of another person. Therefore, when a weight-of-evidence assessment is submitted by an applicant, it would be prudent for the regulatory authority to conduct its

---

<sup>18</sup> Note that the standard of evidence required by the ‘unless’ clause is ‘clearly establish’, which is much stronger than ‘on balance’.

own weight-of-evidence assessment separately, compare the conclusion with that of the applicant, and consider the reasons for any differences.

It is sometimes objected that characterising uncertainty is unhelpful in decision-making. In fact, it is essential for risk assessors to characterise uncertainty, as is clear from Directive 91/414/EEC ('clearly establish') and from policy statements by the EC (Madelin, 2004). Furthermore, practical options exist for dealing with uncertainty in decision-making. Two of the principal options are to request more data to reduce uncertainty, or to request more refined evaluation or analysis of the existing uncertainty. A third option is to counter the uncertainty by applying risk mitigation options, so that the chance of adverse impacts is limited to an acceptable level.<sup>19</sup> However, choosing between options for dealing with uncertainty involves risk management considerations outside the scope of this document such as the acceptability of effects, the degree of certainty required and potentially other factors such as the cost and time required for further refinement, the need to respect legal deadlines for authorisations, and the consequences of risk mitigation or non-authorisation (e.g. reduced efficacy, reduced choice of pest control options in agriculture, risk of resistance, etc.).

In summary:

- Every refined risk assessment should conclude with an overall characterisation of risk, in terms relevant for decision-making. It is recommended to begin with the consideration of whether the evidence makes any mortality or reproductive effects unlikely. Where this is not satisfied, attention should turn to characterising the levels of mortality and reproductive effects that may occur, and using this to evaluate whether there is a high certainty that the magnitude of effects on colonies should not exceed 7% reduction in colony size and that forager mortality should not be increased compared with controls by a factor of 1.5 for six days or a factor of 2 for three days or a factor of 3 for two days.
- The overall characterisation of risk should be derived by a qualitative weight-of-evidence assessment considering all relevant lines of evidence and their uncertainties using a systematic tabular approach (e.g. Table 2). If the overall characterisation is expressed qualitatively (in words) rather than quantitatively, great care should be taken to describe the outcome and its uncertainty as clearly as possible.
- The first tier assessment should always be included as one of the lines of evidence and given appropriate weight (this will be higher for acute risks of sprayed pesticides than for other types of assessment).

---

<sup>19</sup> "In cases where both the potential risk and scientific uncertainties are high, the risk manager may conclude that a precautionary approach is appropriate." (Madelin, 2004).

**Table 3:** Tabular approach recommended for qualitative weight-of-evidence assessment, summarising the conclusion and uncertainties for several lines of evidence and using them to develop an overall conclusion. See Appendix C., Tables C3 and C4 for practical examples. The +/- symbols indicate whether each source of uncertainty has the potential to make the true risk higher (+) or lower (-) than the indicated outcome. The number of symbols provides a subjective relative evaluation of the magnitude of the effect (e.g. - - - might indicate an uncertainty that could reduce risk by an amount equivalent to reducing a TER by about a factor of 10). If the effect could vary over a range, lower and upper evaluations are given (e.g. -/++ or +/-+).

	Lines of evidence ( <i>add more columns if appropriate</i> )		
	First tier assessment ( <i>should always be included</i> )	Second line of evidence	<i>Add one column for each line of evidence</i>
Main contributions to uncertainty:			
Concise description of first major source of uncertainty	+ and – symbols (see legend)		
Second uncertainty			
Add one row for each major source of uncertainty			
Conclusions for individual lines of evidence	Insert overall assessment for each line of evidence		
Overall conclusion	Insert overall conclusion giving appropriate weight to each line of evidence, taking account of their relative certainty (more uncertainty = less weight). The overall conclusion should be a balanced judgement and not simply a summation of the plus and minus symbols.		

## **5. Exposure assessment for bees resulting from consumption of nectar and pollen and assessment of contact exposure**

### **5.1. Exposure assessment for consumption of nectar and pollen entering the hive**

#### **5.1.1. Specification of the exposure assessment goal**

As described in chapter 2, the proposed goal of the exposure assessment is to provide concentrations corresponding to a 90<sup>th</sup> percentile worst case for the hives at the edges of treated fields in the area of use, in the context of registration at EU level. The exposure assessment described in the following sections is based on this 90<sup>th</sup> percentile, as agreed by risk managers.

The total area to be considered for assessing this 90<sup>th</sup> percentile depends on the type of registration. Options include (i) the whole EU (e.g. for seed treatments), (ii) one of the regulatory zones, (iii) a certain climatic zone or (iv) a Member State. Usually the selected option is linked to the concept of a safe use of significant size. Let us consider, for example, an application of an insecticide in strawberries: the issue is then whether the SCoFCAH considers a safe use in strawberries in, for example, Greece sufficient for EU registration or would like to have a safe use in the whole southern zone. This may be different for different types of applications of the substance and will need to be clarified at a later stage. This guidance will further refer to the total area to be considered as ‘the area of use of the substance’.

As described in chapter 2, the exposure assessment goal is defined as the colonies at the edges of treated field in the area of use of the substance. As will be described below, the exposure of such colonies may be caused not only by residues in nectar and pollen from plants in the treated field, but also by residues in nectar and pollen from other plants, e.g. attractive adjacent crops or attractive succeeding crops. For such other plants it becomes a point of debate whether the spatial statistical distribution should be defined as (A) the hives at the edge of the treated fields or (B) the hives at the edge of the adjacent or succeeding crops. The populations A and B will be different. For example, not all fields with a certain attractive succeeding crop in an area of use will have had the treated crop as its precursor crop. In order not to complicate the exposure assessment by such shifts in the definition of the spatial population of the hives, we propose to stick to the same definition of the spatial population of the hives for all types of plants, i.e. those at the edge of fields treated with the substance considered (option A). This is justified because, in principle, this population exists, e.g. even if the treated crop is followed by an unattractive crop; there may be a hive at the edge of this field next year because of other attractive crops in the landscape.

Please note that this specification of the exposure assessment goal applies not only to the risk resulting from consumption of nectar and pollen entering the hive, but also to the risks resulting from consumption of honeydew, guttation water, surface water and puddle water. However, this specification does not apply to the risk resulting from consumption of nectar during foraging because this risk might be greater for colonies that are at some distance away from the treated field.

#### **5.1.2. Relationship between the exposure assessments of honey bees, bumble bees and solitary bees**

This chapter deals with the exposure assessment of bees through consumption of nectar and pollen. Except for this first part, the chapter considers only the exposure assessment of the honey bees. As will be described below, this exposure assessment focuses on the concentration in nectar and pollen in the beehive (which is an average of the concentrations in all types of attractive plants in the foraging area). We consider the approach described for the honey bees also valid for bumble bees because they form a nest which can be considered the equivalent of a hive with respect to exposure. However, the approach is not yet operational for the bumble bees because we are unable to provide guidance on the attractiveness of different plant species to bumble bees (whereas this attractiveness plays an important role in the approach).

The approach is, of course, not applicable to the solitary bees. The first problem for the solitary bees is that they do not fit into the exposure assessment goal described above. It is proposed to consider as the exposure assessment goal the populations of solitary bees living at the edges of treated fields. As will be described below, the approach for the honey bees is based on approaches for the different types of attractive plants in the foraging area. Following our proposal for the exposure assessment goal of the solitary bees, it seems defensible to base the exposure assessment for the solitary bees on the approaches described below for the different types of attractive plants. It should be noted that this is a quite conservative exposure assessment goal for the solitary bees because only a small proportion of all solitary bees will live at the edges of treated fields.

### 5.1.3. Selection of the ecotoxicologically relevant type of concentration

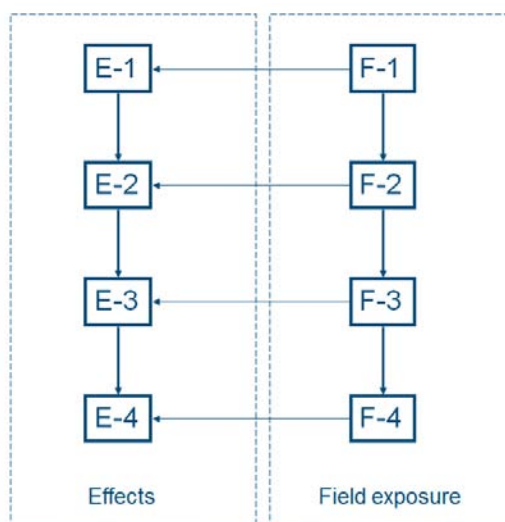
As described by EFSA Panel on Plant Protection Products and their Residues (PPR) (2010), any assessment of the risk to organisms has to be based on concentrations that are most relevant for the effect (called the ecotoxicologically relevant concentrations, abbreviated ERCs). This part of the guidance deals with the risk to colonies of honey bees resulting from consumption of nectar and pollen in the hive. This consumption is considered an important driver for possible effects on colonies. Such effects are likely to be related not to concentrations in nectar and pollen collected by an individual bee but to the average concentration in the nectar and pollen entering the hive. Therefore, it is proposed to assess the maximum average concentration entering the hive over time. An alternative would be to consider the average concentration in the honey or pollen present in the hive. However, this would require that the history of the hive before the application of the substance (and also the behaviour of the beekeeper) be part of the exposure assessment. This would complicate the exposure assessment considerably. It should be kept in mind that the maximum average concentration entering the hive over time will be higher than the maximum average concentration present in the hive over time. So the type of ERC proposed above is likely to be on the conservative side.

### 5.1.4. Principles of linking of exposure and effect assessment

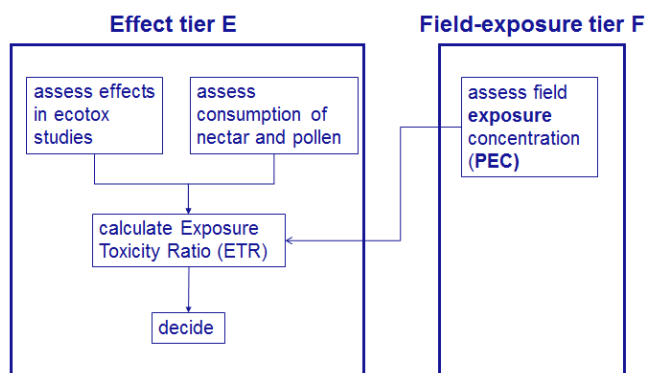
The risk assessment schemes for the honey bees in Section 3 contain in the lower tier assessment of ETR values, which are ratios of exposure and toxicity concentrations. Thus, they require assessment of exposure concentrations. In the higher tiers, they require semi-field and field studies that should be carried out at exposure levels exceeding the 90th percentile hive at the edge of treated fields. It is the purpose of the exposure assessment to feed the appropriate exposure concentrations into the risk assessment schemes.

The underlying principle behind the linking of exposure and effects in this risk assessment is the concept of parallel tiered assessment of effect and exposure, as described in Figure 8 of the EFSA protection goal opinion (EFSA Panel on Plant Protection Products and their Residues (PPR), 2010). Figure 2: shows a simplified version of this figure. Figure 3 zooms in on a combination effect and exposure assessment tier using the evaluation of an ETR quotient in a lower effect tier as an example.

Figure 4: shows two possible conceptual models for possible routes through the combined effect and exposure assessment schemes (Boesten et al., 2007). In the 'ladder model', the level of sophistication of the effect assessment is strictly linked to the level of sophistication of the exposure assessment. In principle this is undesirable, because changes in the exposure assessment may also influence the effect assessment (e.g. the design of higher tier effect studies). It is also more cost-effective to have freedom to refine either the effect assessment or the exposure assessment (i.e. the criss-cross model). So the risk assessment for the exposure of honey bees via nectar and pollen has been set up based following the criss-cross model as much as possible.

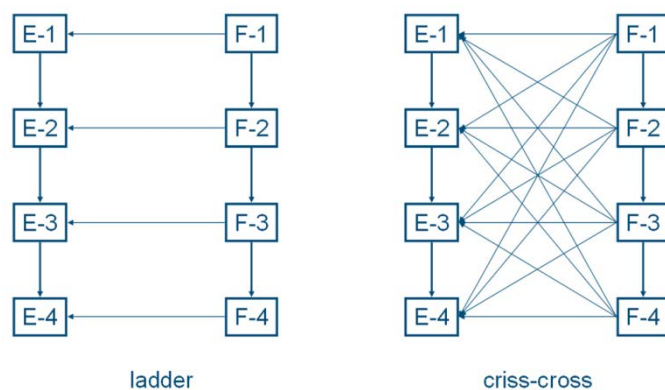


**Figure 2:** Combined tiered effect and exposure schemes for addressing a risk assessment problem. The boxes E-1 to E-4 are four effect tiers and the boxes F-1 to F-4 are four tiers for assessment of exposure in the field ('F' from 'field'). Downwards arrows indicate movement to a higher tier. Horizontal arrows from the exposure to the effect scheme indicate delivery of field exposure estimates for comparison with effect concentrations in the effect scheme (after Boesten et al., 2007)



**Figure 3:** Schematic representation of activities in a combination of effect and exposure tiers, using an effect tier based on an exposure toxicity ratio (ETR) as an example. Note: PEC is the acronym for predicted environmental concentration, but it may also be based on measurements.

Let us consider, as an example, Step 3 of the [risk assessment scheme for spray applications](#) from chapter 3. In this step, it is checked whether  $ETR_{adult}$  is above or below 0.03. This can be done, in the first tier, based on the default conservative exposure estimates. If these lead to an  $ETR_{adult}$  above 0.03 (i.e. potentially harmful for adults), the risk assessor can then choose to go to higher tier effect studies or to go to higher tier exposure (including risk mitigation), as is described in Step 7 of the same risk assessment scheme.



**Figure 4:** Diagrams of two different conceptual models of possible routes through combined effect and exposure assessment schemes. The boxes E-1 to E-4 are four effect tiers and the boxes F-1 to F-4 are four tiers for assessment of exposure in the field. The left part shows routes in which each effect tier is at the same level of sophistication as the exposure tier (called the ‘ladder’ model). The right part shows all possible routes (called the ‘criss-cross’ model). Downward arrows indicate movement to a higher tier. Arrows from right to left indicate delivery of field exposure estimates to the indicated effect tiers (after Boesten et al., 2007)

### 5.1.5. The need for an exposure assessment at landscape level

Bees from a hive at the edge of a treated field sample nectar and pollen not only from the treated field, but also from other fields. Effects on colonies are likely to be related not to concentrations in nectar and pollen collected by an individual bee but to the average concentration in the nectar and pollen entering the hive (which is the target of the proposed exposure assessment). This average concentration depends on the concentrations in nectar and pollen in the whole foraging area of a hive and on the sampling strategy of its foragers.

Appendix E. describes a first simple model for assessing the average concentration entering a hive, considering a foraging area that consists of different types of crops, i.e. a landscape-level approach. At this stage, there is not yet a consensus on a model for obtaining the average concentration in the hive based on the spatial distribution of concentrations in nectar and pollen in the foraging area of the hive. There is also no consensus on the size of the foraging area of a hive, although this will be at least in the order of the radius of one to three kilometres around a hive. Therefore, we propose a conservative approach assuming that bees in a hive forage exclusively on one type of plant (treated crop or other plants in treated field or adjacent crop, etc.). This conservativeness is likely to have a large effect on the resulting concentrations, and may thus also have a large effect on the acceptability of a risk resulting from a certain use. This is especially the case because the conservativeness of the exposure in higher tier effect experiments is to a large extent based on restricting the foraging area as much as possible to the treated field (e.g. by using *Phacelia* or application in tunnels). Therefore, we recommend developing guidance for a landscape-level exposure assessment in the near future.

There is one exception to this conservative approach: if the 90<sup>th</sup> percentiles of the nectar and pollen concentrations are determined via field exposure studies (with analysis of residues in both the treated field and in bees entering the hive) then it is considered acceptable to include (to a limited extent) the dilution in the nectar caused by alternative foraging (see [Appendix E](#) for details).

### 5.1.6. The hierarchy of the exposure assessment

We propose structuring the exposure assessment first on the basis of the application method of the substance and next on the type of plants that may generate the nectar and pollen. The justification for first addressing the application method is that this may have a very large effect on the exposure (e.g. dusts being generated only by seed treatments or granules), and that it is linked to a certain use, and thus to the regulatory decision-making (see EFSA Panel on Plant Protection Products and their Residues (PPR) (2012b), for similar considerations with respect to the exposure assessment for soil organisms).

For the justification for addressing type of plants generating nectar and pollen, let us consider, for example, the concentration in nectar. Bees may sample nectar from (i) the treated crop, (ii) weeds in the treated field, (iii) adjacent crops, (iv) plants in field margins and (v) plants growing during the next growing season in the treated field. The nectar concentrations of these type of plants may differ greatly. For example, if a spray application occurs only after the flowering period of the treated crop, this is likely to lead to low or negligible exposure in the treated crop, but not necessarily low concentrations in weeds in the treated field, because the weeds in the treated field may flower during application. Spray drift from orchards outside the treated field may be about 20% of the applied rate in the first metres (FOCUS, 2001), and may be deposited on plants that are flowering during the time of application. These examples indicate that different types of plants result in different types of exposures, and thus require different exposure assessment flow charts.

The next two sections will provide an overview of the exposure assessments for spray and solid applications. This overview includes the different types of plants for which exposure assessments should be performed.

Risk mitigation via exposure mitigation has played an important role in regulatory risk assessment/management for honey bees for decades. It is therefore an essential part of exposure assessment procedures. Thus, risk mitigation measures have been integrated at the appropriate points in the exposure assessments (see [Appendix N](#) for details).

### 5.1.7. Overview of the exposure assessment for spray applications

As described in section 5.1.1, the PEC in nectar and pollen must be assessed for all the different types of plants that may be sampled by bees. Figure 5 shows how this assessment works if a refined risk assessment for exposure via pollen and nectar is necessary (as indicated by the risk assessment scheme for spray applications described in [chapter 3.2](#)). As shown in Figure 5, the PECs of all of the types of plants in boxes 1 through 5 have to be considered. Each of these boxes refers to an exposure assessment for which flow charts are given in Appendix N. All these flow charts should be followed in parallel, and the risks resulting from each type of exposure should be evaluated. These flow charts contain many different higher tier options that allow for a more realistic exposure assessment than in the first tier; they also contain a considerable number of risk mitigation options (see [Appendix N](#) for the details).

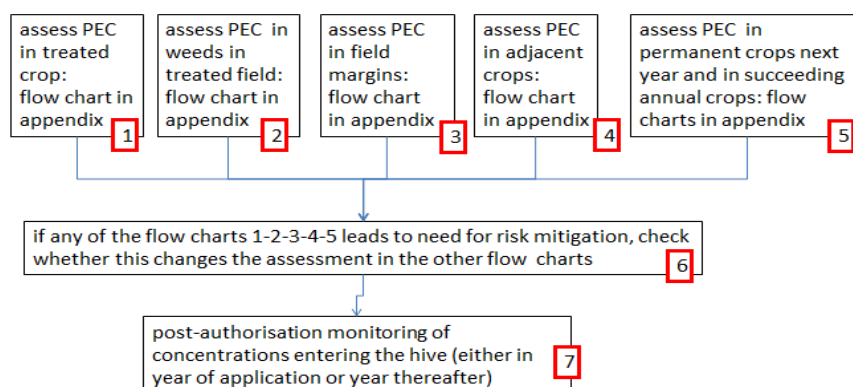
A complication: The flow charts for the exposure from the different types of plants contain many risk mitigation options (e.g. ‘restrict application to post flowering’). If such an option is necessary to conclude an acceptable risk, the use of the substance changes, and this may in turn have an effect on the exposure assessment for the other types of plants. Therefore, as Box 6 indicates, if this is the case, the boxes in other flow charts should be checked iteratively, and this process should continue until the assessments in the each of the boxes are consistent with each other.

Risk managers may wish to have some form of post-authorisation monitoring to ensure that the risk is indeed acceptable, or to confirm the underlying risk assessment. Article 66 of EC Regulation 1107/2009 offers this possibility (‘Producers of Plant Protection Products shall undertake post-authorisation monitoring on the request of the competent authorities.’). Therefore, Box 7 in Figure 5: offers the possibility of assessing the actual exposure based on monitoring of concentrations in the nectar and pollen entering hives at the edge of treated fields. Such monitoring data must, of course, be targeted to the exposure assessment goal (i.e. 90th percentile of hives at edges of treated fields in the area of use of the substance). They also have to be targeted to the most critical area of the exposure assessments in the lower tiers (e.g. if the most critical area was the concentrations in a succeeding crop then the monitoring should target hives at edges of fields of this succeeding crop). This leads to the following provisional and non-exhaustive list of monitoring requirements:

- The use in the whole foraging area (provisionally set as a circle around the hive with a radius of three kilometres) should be representative of the use in the area

- of use of the substance, and all farmers should follow the risk mitigation measures on the label, as the concentration in the hive is influenced by the use in the entire foraging area.
- The use of the product in the foraging area during the monitoring period should be recorded.
  - In view of possible effects of weather conditions, monitoring data should be available for more than one year.
  - For assessment of exposures in adjacent crops, monitoring should include measurements of wind direction on the day(s) when the substance is applied to the treated field.
  - For assessment of exposures in field margins, monitoring should include information on occurrence of field margins around the treated field, in relation to the wind direction on the day(s) when the substance is applied to the treated field.
  - The time course of the concentrations in nectar and pollen entering the hive should be followed by sampling returning foragers (e.g. with a vacuum cleaner). For monitoring in the same year as initial applications this should begin before application(s) of the substance and continuing until the concentration has clearly passed its maximum value. For monitoring the year after application, this should start before flowering of the crop and again continuing until the concentration has clearly passed its maximum value. At the end of the exposure assessment study the concentrations in the stores in the hive should be measured, as well.
  - It is advisable to perform the monitoring mainly in areas with high intensity of use of the substance because this intensity is likely to influence the 90<sup>th</sup> percentile case.

From the results of such monitoring studies, the 90<sup>th</sup> percentile should be derived using appropriate statistical analyses based on the spatial population as previously defined, using all relevant information. In principle, it is of course also possible to perform a few such studies pre-registration. However, this would require agreement from risk managers to apply the substance pre-registration in a number of fields distributed in an area of some 30 km<sup>2</sup>, in view of the estimated 3-km radius required for the foraging area.



**Figure 5:** Scheme for the exposure assessments for the PECs in nectar and pollen collected by the bees after spray applications.

The scheme in Figure 5: does not consider the PEC in adjacent crops and field margins in the year(s) following the year of application because for spray applications these PECs will be smaller than those in the treated field in the year(s) following the year of application. The scheme chart also does not consider weeds in the year after application in permanent crops and in succeeding annual crops (either in year of application or in year after application) because the concentrations in the nectar and pollen in these weeds are also expected to be smaller than those in the weeds in the application period.

## 5.1.8. Overview of the exposure assessment for solids

### 5.1.8.1. Introduction

Solids are defined as seed treatments, pellets, granules, etc. Solid formulations (e.g. wettable powders) that are mixed with water and then sprayed are part of the spray exposure assessment. EU regulations (article 3, item 17) prescribe that PPPs that are used as seed treatments are registered at the EU level, not at zonal or MS levels. This is based on the concepts (i) that the use of the PPP is linked to the coating of the seed, not to the sowing of the seed, and (ii) that there should be free trade of treated seeds across the EU. So the area of use of the substance for seed treatments is the whole surface area in the EU where the crop will be grown from the treated seed in question.

At first glance, one might think that the exposure assessment of granules can be based on the exposure assessment of seed treatments. However, the assessment of the concentrations in pollen and nectar resulting from granule applications has similarities with both that resulting from spray applications and that resulting from seed treatments. The similarities with the spray applications are that the substance is usually applied to the whole soil surface (not only to the seeds) and that registration decisions are made at the national level. The similarity with the seed treatments is that granule application also leads to dust emission. So the exposure assessment for the granules contains elements of both the spray applications assessment and seed treatments assessment.

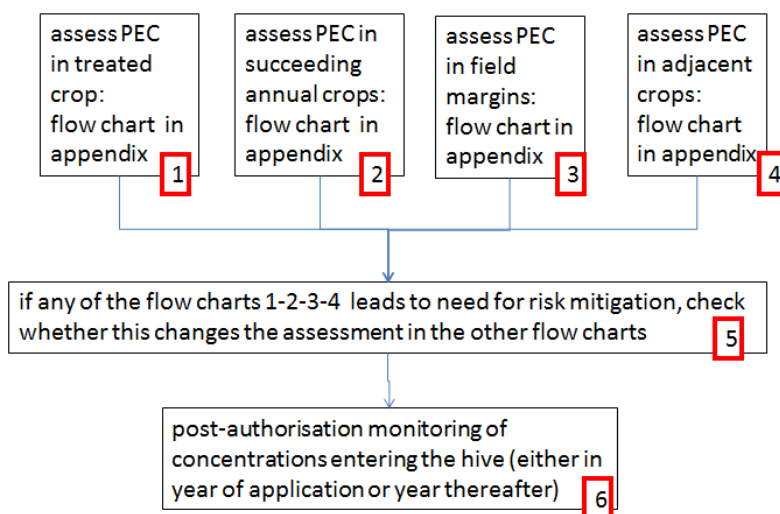
### 5.1.8.2. Exposure assessment for seed treatments

Following the same reasoning as for the spray applications, the PEC in nectar and pollen after seed treatments has to be assessed for all the different types of plants that may be sampled by bees. The scheme in Figure 6 shows the same types of plants as for the spray applications (in Figure 5: ) except the weeds in the treated field. The weeds in the treated field are unlikely to be an issue in view of the application via the seed treatment, in that no weeds will be present in the field when the crop is sown. Also, uptake via the roots of weeds is likely to be negligibly small in the application year because the substance is concentrated around the treated seed. Admittedly, weeds may lead to higher exposure in the treated field than the treated crop if the treated crop does not flower (but the weeds do). However, there is currently no up-to-date guidance for soil exposure resulting from seed treatments. The EFSA Panel on Plant Protection Products and their Residues (PPR) (2012b) developed such guidance for spray applications but not for other types of applications (such as seed treatments). Therefore, we recommend developing such guidance for seed treatments and using this to assess the uptake by the weeds in the treated field. Until this has happened, we suggest ignoring this exposure scenario in the seed treatment assessment.

The flow chart in Figure 6 (in box 6) also contains the option of post-authorisation monitoring as in Figure 5: See section 5.1.7 for guidance on monitoring procedures.

The mechanism of exposure in the treated crop (box 1), and in succeeding annual crops (box 2), differs completely from that in the field margin and in an attractive adjacent crop (boxes 3 and 4). The treated crop is exposed because its seed is coated with the substance which leads to uptake by the roots of the crop. This substance is then taken up and transported to the nectar and pollen of the treated crop. Similarly, the roots of succeeding crops may take up soil residues from seed treatments. However, plants in field margins and of an attractive adjacent crop are exposed through the dust that is generated by sowing the treated crop and which is deposited on them. See Appendix N. for a detailed description

of boxes 1 to 4 of the flow charts. These flow charts contain many higher tier options that allow for a more realistic exposure assessment than in the first tier (see [Appendix N](#) for the details).



**Figure 6:** Flow chart for the exposure assessments for the different types of plants sampled by the bees after seed treatments.

In principle, it is possible that dust deposition will occur on bees that are foraging on honeydew in field margins or in adjacent crops, or that such dust deposition will contaminate honeydew, which is then taken up by foraging bees. We propose that the exposure of honeydew due to dust deposition not be assessed, because we expect that it will lead to a lower level of exposure than from exposure via flowering plants in the field margins.

### 5.1.8.3. Exposure assessment for granules

Granules can be applied in different ways: (i) simply broadcasted, (ii) incorporated into the soil or (iii) buried with the seed. They can be applied both in permanent and in annual crops. When buried with the seed, the similarity in behaviour of the substance with the seed treatments is of course greater than for the other application methods. If granules are broadcasted after the emergence of the crop and the weeds, there are more similarities with spray applications. The guidance intends to cover all granule application methods. During application, dust is formed from the granules, which can then be deposited onto the crop (if present) or onto plants in field margins or adjacent crops. In view of these possibilities, we propose to use the spray applications scheme (Figure 5) to assess the concentrations in nectar and pollen from the different types of plants. This means only that the exposure assessment for the granules considers the same types of plants as sources of nectar and pollen as the exposure assessment for spray applications. This does not mean that the exposure assessment for the granule applications is identical to that for the spray applications; the exposure assessment for granules is further explained in Section 3.3 of Appendix N. The first screening steps for the infield scenarios (i.e. treated crop, weeds) are very conservative for granules because it is unlikely that a granule grain will end up in the flowers, and because the dust deposition onto the treated field is probably only a small fraction of the dose. See [Appendix N](#) for further details on the exposure assessment of granules. Please note that also flow charts for the granules in Appendix N contain a number of higher tier exposure options that allow for a more realistic exposure assessment than in the first tier.

## 5.2. Exposure and risk assessment resulting from contact exposure

### 5.2.1. Exposure assessment goal and combination with effect assessment

In the contact exposure assessment, the spatial unit to be assessed is the population of foragers present in a hive at the edge of a treated field. The statistical spatial population of spatial units consists of all

forager populations in hives at edges of treated fields in the area of use of the substance. The exposure assessment was based on the 90<sup>th</sup> percentile of all these populations of foragers (to be consistent with the exposure assessment goal for the population in the hive as used in section 5).

The next step is to define the type of exposure concentration to be assessed. This is the mass of substance to which a single forager is exposed (usually expressed in µg).

The effect assessment is based on the requirement that the mortality percentage of the whole forager population should be less than a certain value; let us call this value  $M_{acc}$  (the acceptable mortality).

So conceptually the problem is to combine the cumulative frequency distribution of the mass of substance to which a single bee is exposed with the dose response curve, and then calculate the average mortality using this distribution. The calculation procedure is straightforward: plot the mortality percentage as a function of the exposure percentile and calculate the average mortality over the full range of the exposure (see Verdonck et al. (2003) and see Figure M3 for an example of such a plot).

[Appendix M](#) describes a conservative approach based on a linear cumulative probability density of the mass to which a bee is exposed in combination with a linear dose-response curve. This results in a percentage mortality ( $M$ ) that is directly proportional to the cumulative exposure percentile ( $F_e$ ). This gives the equation:

$$M = 2M_{acc}F_e \quad (1)$$

where  $M_{acc}$  is the acceptable mortality (%). The background is that this equation gives an average mortality (for  $F_e$  between 0 and 1) equal to  $M_{acc}$  (see Figure M3).

The above proposed guidance should be seen as an interim solution while there is no further information on the cumulative frequency distribution of exposure available (see [Appendix M](#)). If a reliable cumulative frequency of contact exposure becomes available, there is no need for these simplifying assumptions. At such a time, the LD<sub>50</sub> curve and the cumulative frequency distribution can be combined into a plot of the mortality as a function of the exposure percentile and the resulting average mortality can be calculated from the area under the curve (AUC).

### 5.2.2. HQ approach

For decades, the risk assessment for contact exposure has been based on the HQ quotient defined as:

$$HQ = A/LD_{50} \quad (2)$$

where  $A$  is the application rate (g/ha), and the LD<sub>50</sub> is the mass per bee at 50 % mortality (µg). The HQ is an integral measure for the combined effect and exposure assessments. The proposed guidance makes use of the HQ approach as much as possible.

Risks for contact exposure should be assessed not only in the treated field but also in field margins and in adjacent fields. The exposure may be less than in the treated crop because only part of the dosage will be deposited onto the field margins or the adjacent fields. In such cases, a broader definition of the HQ is necessary:

$$HQ = f_{dep} A/LD_{50} \quad (3)$$

where  $f_{dep}$  is the fraction of the dose deposited on the type of plants that the foragers visit. For an attractive treated crop, the average  $f_{dep}$  is, of course, 1, but for plants in field margins and adjacent crops it may be considerably less than 1.

### 5.3. Spray applications

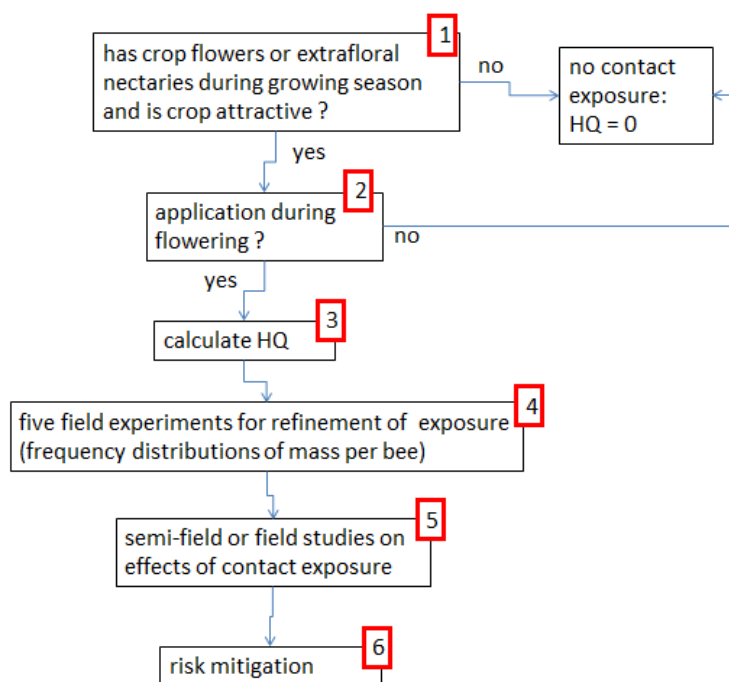
#### 5.3.1. Introduction

Measurements by Koch and Weisser (1997) showed that contact exposure resulting from spray applications is highest during application and decreases considerably within one hour after application. This is probably because the water sprayed during application usually evaporates in the first hour after application (see [Appendix N](#) section 3.2) and most contact exposure is the result of bees coming into contact with the spray liquid.

The principle of the proposed scheme (below) is that there will be only contact exposure in attractive plants.

#### 5.3.2. The treated crop

The approach for the treated crop is described in the flow chart of Figure 7: Box 1 tests whether the crop attracts bees. If not, the risk assessment for contact exposure can be skipped. If it does attract bees, whether application is during flowering is checked (box 2). If not, there is again no risk for contact exposure and the rest of the assessment can be skipped. The assessment for the treated crop scenario can be skipped also for non-crop directed applications (i.e. when the crop itself is not oversprayed). If the substance is applied during flowering, the HQ has to be assessed with Eqn 1 or Eqn 2 with  $f_{dep} = 1$  (box 3). As explained in [Appendix M](#),  $HQ < 4 M_{acc}$  for downwards spraying and  $HQ < 8 M_{acc}$  for sideward/upwards spraying.



**Figure 7:** Flow chart for the contact exposure in the treated crop after spray applications. The box numbers are used in the text to identify the boxes

If the HQ calculation does not lead to acceptable risk, the exposure may be refined (box 4). This refinement should be based on five field studies, where the product is applied in line with the GAP and bees are actively foraging in the crop when the treatment is applied. It is also acceptable to perform studies with tracers, such as fluorescein. The purpose of the five field studies is to assess the 90<sup>th</sup> percentile case of the cumulative frequency of mass per bee (i.e. the exposure in the study that shows the highest exposure out of the five). The five locations should be representative for the crop of concern and of the proposed use pattern of the product.

See [Appendix M](#) for further details on these field studies. The data from each trial should be transformed into a cumulative frequency of mass per bee (as in Figures M3 or M4) and the highest curve of the five should be combined with the LD<sub>50</sub> curve to assess the average mortality following the procedure as described in Appendix M.

It should be noted that the above field studies (if, for example, performed with a traces such as fluorescein) are valid for the application technique and crop considered and thus have broader scope than the risk assessment of a single substance.

In the case that the refinement of the exposure in box 4 does not lead to acceptable risk, the next step is to perform (semi-)field experiments on the effects of contact exposure (box 5).

When a field effect study is performed, samples of foragers returning to the colonies should be obtained. The study is considered to have appropriate exposure if the cumulative frequency distribution of residue on the foragers is at least the same as the 90<sup>th</sup> percentile from the preceding residue studies in box 4.

If the field effect studies do not lead to acceptable risk, risk mitigation measures are needed (box 6). For example, a warning sentence: “Do not use when bees are actively foraging”.

It is possible that a honey bee colony may be located next to a field that is not attractive to foraging honey bees. The flow chart of Figure 7 would then lead to HQ = 0 based on box 1. Whilst it is accepted that the field itself is not attractive to foraging honey bees, it is possible that honey bees could fly across the field in order to gain access to a flowering crop. If the honey bees fly across the field whilst the field is being sprayed, it is possible that foraging honey bees may fly through the cloud of spray that results from spraying process. This cloud will contain residues of pesticides. Whilst this situation has occurred, and may have contributed to incidents of bee die-off, the likelihood in terms of frequency of occurrence is unknown (moreover, the measurements by Koch and Weisser (1997) indicate that it is unlikely that bees fly through the cloud of spray). Owing to the lack of further information regarding the frequency of occurrence, in terms of either temporal or spatial occurrence, it has been decided not to include this potential exposure pattern in the exposure assessment and associated risk assessment.

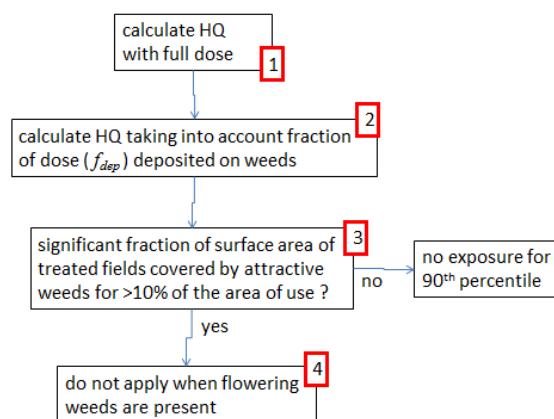
### 5.3.3. Weeds in the treated field

The contact exposure assessment for weeds in the treated field starts with a conservative approach: calculate HQ for the full dose (box 1 in Figure 8: ) using  $HQ < 4M_{acc}$  once again, for both downwards and sideward/upwards spraying. If this does not lead to an acceptable risk, the HQ calculation can be refined by including  $f_{dep}$  based on the fraction of the dose deposited on the weeds (based on Appendix E of EFSA, 2009).

In the case of sideward/upwards spraying, the exposure is based on the measurements for downwards spraying because the contact exposure of the bees while foraging on weeds is expected to be more similar to the conditions in the Koch and Weisser experiment with downwards spraying on *Phacelia* than to the conditions in the Koch and Weisser experiment with sideward/upwards spraying in apples (see Appendix M.). Moreover, the experiment with downwards spraying resulted in higher exposure, and thus a more conservative approach for the risk assessment.

If the boxes 1 and 2 in Figure 8 do not lead to an acceptable risk, it may be checked whether it is likely that a significant fraction of the surface area of the treated fields is covered by weeds at the application time. If this is likely in less than 10% of the area of use of the substance, no weeds will occur in a 90<sup>th</sup> percentile case and thus their role in the contact exposure can be ignored (box 3; see Section 2.3 of [Appendix N](#) for further considerations with respect to this box).

If this does not lead to an acceptable risk, the risk can be mitigated by not applying when flowering weeds are present (box 4). See chapter 9 for details on [risk mitigation measures](#).



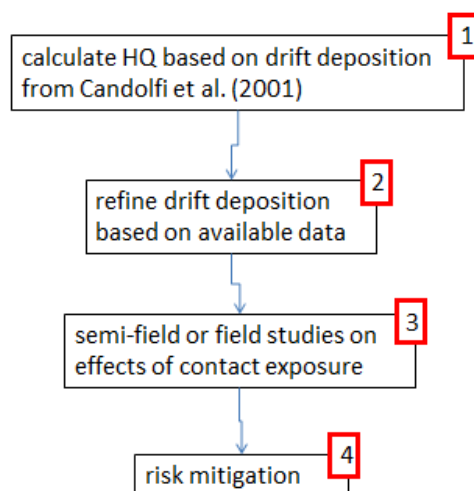
**Figure 8:** Flow chart for the contact exposure for weeds in the treated field after spray applications. The box numbers are used in the text to identify the boxes

A consequence of this risk assessment could be that the farmers decide to remove all plants from underneath trees in orchards, which may also have adverse effects on pollinators.

### 5.3.4. Plants in field margins

As described at the end of [Appendix N](#), the contact exposure assessment for the plants in the field margin has the additional complication that the mass deposited onto the field margins depends on factors such as the wind speed and wind angle. As described at the end of the section: 'Determining a trigger value for an acute contact exposure' in [Appendix M.](#), in the absence of further probabilistic analysis, we propose to use the 90th percentile of the mass deposited in the field margin for the exposure assessment of the population of foragers from a hive at the edge of a treated field. Please note that this 90th percentile is a different 90th percentile than the one mentioned in the introduction of this chapter. In the introduction it is stated that the contact exposure assessment goal is based on the 90th percentile exposure of all forager populations in the area of use of the substance.

We assume that all foragers from a hive forage on the attractive plants in the field margin (conservative assumption). For plants in field margins it has to be considered that there may be field margins all around the treated field, and that the assessment of the local 90<sup>th</sup> percentile exposure should consider the effect of the wind angle on the deposition. However, in the absence of better alternatives, it is proposed to take the spray drift deposition figures by Candolfi et al. (2001) for a single application at distance of one metre for downwards spray applications (in field crops) and at a distance of three metres for sideward and upwards applications (in fruit crops and grapevine) for both single and repeated applications. These are based on downwind measurements, and thus are likely to approach a local 90th percentile. This gives  $f_{dep}$  values of 2.77% for field crops, 29.2% for early fruit, 15.7% for late fruit, 2.7% for early grapevine, 8.0% for late grapevine and 19.3% for hops. These figures can be improved by analysing all relevant drift data available in literature, and we recommend that this be done.



**Figure 9:** Flow chart for the contact exposure for plants in field margins after spray applications. The box numbers are used in the text to identify the boxes

The flow chart in Figure 9 starts with box 1, in which the HQ is calculated with Eqn 3, using the above  $f_{dep}$  values. This should be tested based on  $HQ < 4M_{acc}$  for both for downwards and sideward/upwards spraying. Sideward/upwards spraying should be tested against the criterion for downwards spraying because the contact exposure for the bees in the field margin is expected to be more similar to the conditions in the Koch–Weisser experiment with downwards spraying on *Phacelia* than to the conditions in the Koch–Weisser experiment with sideward/upwards spraying in apples (see [Appendix M](#)), as mentioned above.

The next step (box 2) is to analyse all relevant available drift data in order to refine the drift deposition factor. The target should be to select such a drift deposition that the acceptable mortality is not exceeded for the 90th percentile population of foragers. Please note that this is a generic refinement which is not linked to a specific substance.

If box 2 does not lead to acceptable risk, the next step is to perform (semi-)field experiments on the effects of contact exposure (box 3) similar to those for the risk assessment for the treated crop. As in the studies for the treated crop, the contact exposure of the bees should be measured and be at least as high as expected in the 90th percentile exposure case.

If the risk is still not acceptable, risk mitigation measures are needed to reduce the spray drift onto the field margins (box 4 in Figure 9).

### 5.3.5. Adjacent crops

In the case of an attractive adjacent crop, the forager population will forage on the whole adjacent crop surface area, not only on the crop plants close to the treated field. As described in Appendix H., it is proposed to consider a 50-metre width of the adjacent crop field. Let us consider, as a worst case, only treated fields with an attractive adjacent crop downwind on the day of application (though only a fraction of the treated fields will have downwind attractive adjacent crops). Following the same approach as for the plants in the field margin, the local 90th percentile deposition has to be assessed. The 90th percentile of exposure within this field will be at five metres distance from the border of the adjacent crop field and the treated field. Considering this, the exposure of bees in the adjacent crop will always be lower than in the field margins. Thus, the assessment for adjacent crops is covered by the assessment for the field margins.

## 5.4. Seed treatments

### 5.4.1. Introduction

The assessment for seed treatments, below, also includes granules which are drilled or buried in the soil with the seed.

### 5.4.2. The treated crop

Effects resulting from contact exposure via dust in the treated field have been studied by Girolami and co-workers (see, for example Girolami et al. (2013)), including residue analyses of the exposed bees. Girolami et al. (2013) showed that effects of neonicotinoids were observed in a cloud with an ellipsoidal shape with about 20 metres diameter when deflectors that direct the dust cloud towards the soil surface were used.

It is possible that a honey bee colony may be located next to a field that is to be drilled with treated seed. Whilst it is accepted that the field itself is not attractive to foraging honey bees, it is possible that honey bees could fly across the field in order to gain access to a flowering crop. If the honey bees fly across the field whilst the treated seed is being drilled, it is possible that foraging honey bees may fly through the cloud of dust that results from drilling process. This cloud may contain residues from the treated seed and hence foraging honey bees could be exposed to pesticides. Whilst this situation has occurred and may have contributed to incidents, the likelihood in terms of frequency of occurrence is unknown.

Based on the exposure assessment goal, the target is to assess whether the mortality of a forager population from a hive at the edge of a treated field will exceed the acceptable mortality resulting from the contact exposure with this dust cloud (considering hives at edges of all treated fields in the area of use, and assessing the 90th percentile case of all these hives). This could be done by simulating the movement of the cloud over the field during the sowing process, and by simulating the flights of the forager population during the sowing process, considering all hives at edges of treated fields in the area of use of the substance. In view of time constraints, such simulations could not be carried out. Owing to this lack of information regarding the frequency of occurrence, in terms of either temporal or spatial occurrence, it has been decided not to include this potential exposure scenario in the exposure assessment and associated risk assessment.

### 5.4.3. Weeds in the treated field

It is expected that no weeds are present during sowing, and therefore no assessment of weeds is required.

### 5.4.4. Plants in field margins

There are no measurements available that relate the mass of substance to which a single forager is exposed to the dust deposition onto surfaces. In the absence of better alternatives, it is proposed that this exposure be based on that measured by Koch and Weisser (1997) for downwards spraying, but to assume that the exposure is three times higher (so to use  $E = 1/3$  in Eqn M-11, which leads to  $HQ = 1.3M_{acc}$ ). In the study of Koch and Weisser (1997), it was demonstrated that exposure to spray liquid is reduced very quickly after application. Dust may remain longer, however, and as a result be more available to bees on plant surfaces. Moreover, dust particles may stick to the hairs of foragers. In order to take into account potential greater effects from contact exposure to dust than to spray liquids it is proposed to use this safety factor of 3. This could be refined in future when data become available from dedicated experiments analogous to the study of Koch and Weisser.

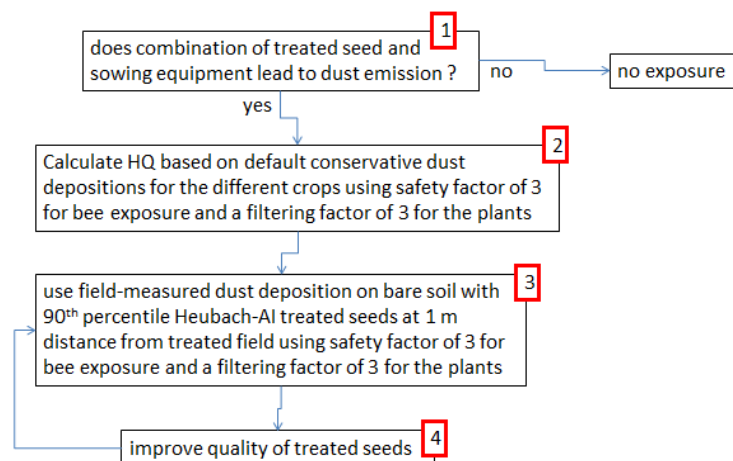
Following the same approach as for the spray contact exposure in the field margins (as described at the end of Appendix M.) leads to the requirement to base the  $f_{dep}$  values for dust deposition on downwind measurements representing a 90th percentile worst case.

It is proposed that the risk assessment be based on a certain type of sowing equipment (assuming that this is the intention of the risk managers). The first step in the risk assessment is then to check whether the combination of treated seed and sowing equipment leads to dust emission (box 1 of Figure 10). This can be based on [Appendix C](#).

The next step (box 2) is to evaluate HQ based on conservative dust deposition figures as described in Appendix H, and to use a filtering factor of 3 to account for the fact that the plants in the field margins catch more substance than bare soil (see [Appendix H](#)). This leads to  $f_{dep}$  values of 1.7% for maize, 0.66% for oilseed rape, 0.99% for cereals and 0.003% for sugar beets for drills with deflectors and to  $f_{dep}$  values of 17% for maize, 6.6% for oilseed rape, 9.9% for cereals and 0.03% for sugar beets for drills without deflectors.

If this does not lead to acceptable risk, it is recommended (box 3) that a portion of treated seed be found that has an approximately 90<sup>th</sup> percentile Heubach-AI value, considering the seed treatment facilities that are relevant for the area of use of the substance (see section 3.2 of [Appendix N](#) for further guidance on this selection). This 90<sup>th</sup> percentile is based on the exposure assessment goal described in the introduction of this chapter (90<sup>th</sup> percentile of the statistical population of all forager populations in hives at edges of treated fields in the area of use of the substance). A field experiment should then be carried out (box 3) with this portion of treated seed, in which the dust deposition at one metre distance from the treated field is measured (see Appendix N. 3.2 for guidance on how this field experiment should be carried out). The depositions derived from this experiment can be used to refine the dust deposition onto plants in the field margin (still using the filtering factor of 3 and the safety factor of 3 for the dust, so  $HQ = 1.3M_{acc}$ ).

If this does not lead to acceptable risk, then it may be an option to attempt to improve the quality of the treated seeds (box 4).



**Figure 10:** Flow chart for the contact exposure for plants in field margins after seed treatments. The box numbers are used in the text to identify the boxes

### 5.4.5. Adjacent crops

As for the spray applications, the 90<sup>th</sup> percentile exposure considering a forager population of a certain hive will always be lower for the adjacent crop than for the field margin, so this risk is covered by the assessment presented above.

## 5.5. Granules

### 5.5.1. Introduction

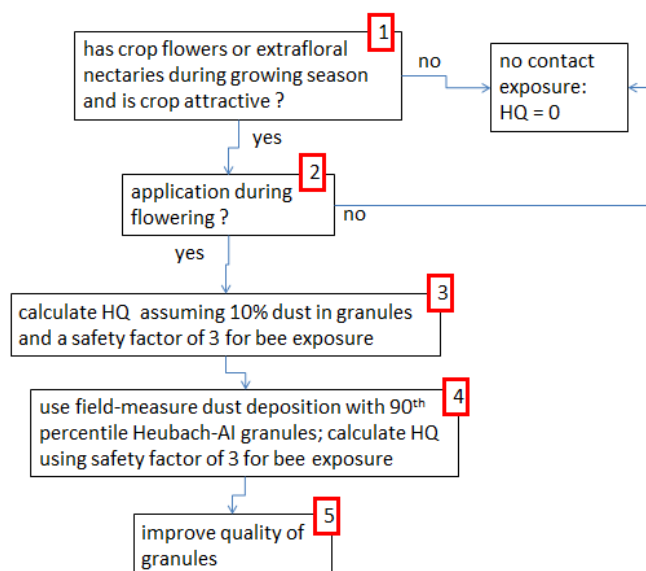
The assessment below is for granules which are applied via broadcast application (granules that are drilled or buried in the soil with the seed are part of the risk assessment for seed treatments as described above).

### 5.5.2. The treated crop

Broadcasted granules may lead to contact exposure due to the dust formed by these granules. Dust clouds from granules may lead to contact exposure similar to that for the seed treatments, but this is not considered here (see the seed treatments for the reasoning as to why not). Here the risk is assessed for dust from granules deposited on the treated crop leading to contact exposure of foragers.

Boxes 1 and 2 for the contact exposure assessment for the treated crop after granule applications are the same as for the spray applications (Figure 11), i.e. checking whether exposure will occur. The next step (box 3) is to calculate the HQ in the same way as for downwards spraying, using the safety factor for bee exposure due to dust deposition (so to use  $E = 1/3$  in Eqn M-11, which leads to  $HQ = 1.3M_{acc}$ ). Furthermore, it is assumed, as a conservative approach, that granules contain 10 % dust, so the  $f_{dep}$  is set to 0.1.

If box 3 does not lead to acceptable risk, it is proposed to find a portion of granules that has an approximately 90th percentile Heubach-AI value, considering all producers of granules that are relevant for the area of use of the substance (see section 3.2 of [Appendix N](#) for further guidance on this selection). Note: If there is only one producer, there is of course no need to find the 90th percentile granule portion. With this portion of granules a field experiment should be carried out (box 4) in which the dust deposition in the treated field is measured. Again,  $HQ = 1.3M_{acc}$  should be used. If this does not lead to acceptable risk, then it may be an option to attempt to improve the quality of the granules (box 5).



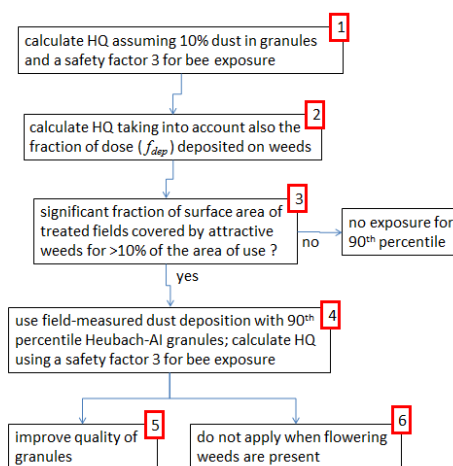
**Figure 11:** Flow chart for the contact exposure for the treated crop after a granule application. The box numbers are used in the text to identify the boxes

### 5.5.3. Weeds in treated field

Contact exposure resulting from attractive weeds cannot be ignored in case of granules. The flow chart presented is a combination of the flow charts for weeds in treated field after spray application (Figure 7) and for the treated crop after granule application (Figure 11).

The first step (box 1 in Figure 13) is to calculate the HQ as for downwards spraying, using the safety factor for bee exposure due to dust deposition (so to use  $E = 1/3$  in Eqn M-11, which leads to  $HQ = 1.3M_{acc}$ ). Furthermore, it is assumed as a conservative approach that granules contain 10% dust, so the  $f_{dep}$  is set to 0.1. The next step (box 2) is to correct for the fraction deposited on weeds (based on Appendix E. of EFSA, 2009). If this does not lead to an acceptable risk, it may be checked (box 3) whether it is likely that a significant fraction of the surface area of the treated fields is covered by weeds at the application time. If this is likely in less than 10% of the area of use of the substance, no weeds will occur in a 90<sup>th</sup> percentile case and thus their role in the contact exposure can be ignored (see Section 2.3 of [Appendix N](#) for further considerations with respect to this box).

The next step (box 4) is to measure the dust deposition for a 90th percentile Heubach-AI granule portion (see previous section for guidance). If these steps do not result in acceptable risk, there is either the option to improve the quality of the granules (box 5) or not to apply when flowering weeds are present (box 6).

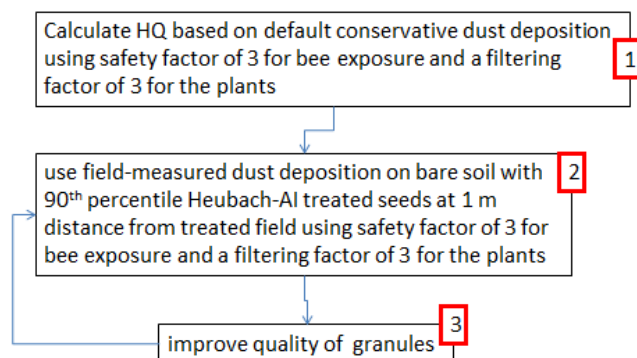


**Figure 12:** Flow chart for the contact exposure for weeds in the treated field after a granule application. The box numbers are used in the text to identify the boxes

### 5.5.4. Field margins

The assessment for the field margins can be based on an approach that is very similar to that for the field margins for seed treatments. The first step (box 1 in Figure 13: ) is to calculate the HQ based on a conservative dust deposition; a figure of 9.6% can be used for granules (see Appendix H), using the safety factor for bee exposure due to dust deposition (so to use  $E = 1/3$  in Eqn M11), which leads to  $HQ = 1.3M_{acc}$ . A filtering factor of 3 has to be used to account for the fact that the plants in the field margins catch more substance than bare soil (see [Appendix H](#)).

The next step (box 2) is to perform a field experiment on dust deposition onto bare soil with 90th percentile Heubach-AI granules at 1 metre distance from the treated field, and to recalculate the HQ based on this data (using  $HQ = 1.3M_{acc}$  and a filtering factor of 3 for the deposition on the plants as above). The last step (box 3), if an acceptable risk has not been reached, is to improve the quality of the granules.



**Figure 13:** Flow chart for the contact exposure for weeds in the field margins after a granule application. The box numbers are used in the text to identify the boxes.

### 5.5.5. Adjacent crop

As for the spray and seed treatment applications, the risk assessment for the adjacent crop is likely to be less critical than that for the field margins and hence is covered by the assessment presented above.

## 6. Effects assessment

Outlined below are laboratory, semi-field and field effects studies for either honey bees, bumble bees or solitary bees; detailed guidance is provided in [Appendix O](#).

In order to ensure that the regulatory risk assessment is sufficiently robust, it is conventional to use only internationally agreed and adopted or noted guidelines in regulatory risk assessment. In using internationally agreed and adopted guidelines, it is assumed that the studies themselves are sufficiently reliable, repeatable and reproducible. However, given the terms of reference and the need to develop a risk assessment, it was necessary to draft guidelines in all of the above areas. This is solely because of the lack of available guidelines. It is appreciated that this is not desirable as the study design may not be ideal; however, the draft guidelines are considered to be appropriate until internationally agreed and adopted guidelines are available. It is proposed that the following draft guidelines should be used until such time that internationally agreed and adopted guidelines are available.

### 6.1. Honey bee effects studies

#### 6.1.1. Laboratory studies

Appendix O presents details of how to carry out acute oral, acute contact, chronic adult toxicity studies and larval toxicity studies. In addition, there is guidance on how to determine the accumulative potential of the active substance. Only two of these studies are internationally recognised and adopted. The other guidelines presented in Appendix O are based on the current state of knowledge; however, it is accepted that the details of the procedures are likely to change as experience grows and as guidelines are adopted.

##### 6.1.1.1. Acute oral and contact toxicity study

This study should be carried out according to OECD 213 and 214. It is important that note is taken of paragraph 20 of this guideline and that all sublethal effects are recorded. Observations should be made as frequently as possible, and it is suggested that once every four hours would be appropriate. In addition, note should be made of the need to continue the study including the observation period up to 96 hours if the mortality continues to rise (increase in mortality by >15% in the 24-48 h period). A detailed report of all sublethal and behavioural effects should be made, as well as an outline of how these were done, e.g. frequency and duration of observation.

##### 6.1.1.2. Chronic toxicity study with adult bees

The guideline outlined in Appendix O is based largely on the approaches of (Decourtye et al., 2005), (Suchail et al., 2001), Thompson H (Food and Environment Research Agency, personal communication, 2012) and (CEB, 2012). The study basically consists of newly emerged worker bees, and these are offered a known weight of a given concentration (or controls) for 10 days. Observations of mortality and behaviour should be carried out at daily intervals up to 10 days. A detailed report of all sublethal and behavioural effects should be made, as well as an outline of how these were done, e.g. frequency and duration of observation. As regards sublethal and behavioural effects, it is proposed that effects on the HPGs are determined. Observation of effects on HPGs development is recommended in order to cover potential effects on brood care, which would otherwise not be covered in the lower tier assessment. The data are used to determine primarily the LC<sub>50</sub> (mg/kg) for the 10d chronic adult mortality and the NOEC (mg/kg) for HPG development should also be determined. Both should be presented as µg/bee/day.

##### 6.1.1.3. Test to determine accumulative potential of the active substance

In order to determine if an active substance has the potential for accumulative effects, i.e. whether an active substance has the same level of effect or response under two exposure regimes, a modified chronic study as outlined above should be carried out. Full details are provided in Appendix O. The results of this study will indicate whether an active substance has accumulative effects and, if so, then, according to the risk assessment scheme, there is a need to consider the risks further.

#### 6.1.1.4. Larvae toxicity studies

It is proposed to use a repeated dose exposure test. An OECD guideline for such a repeated dose study is under development. Until finalisation of the repeated dose study the study protocol of the single dose study (OECD 2013) can be followed except dosing the larvae repeatedly. If a single dose study is available then expert judgement is needed on whether it can be used in the risk assessment. The endpoint used in the risk assessment proposed of the current Guidance Document is based on larvae survival until day 7.

The resulting endpoint is a NOEC<sub>larvae</sub> in terms of µg/larvae/development period.

**Endpoints from the laboratory studies**—the endpoints from the above studies should be collated as follows:

Toxicity study	Endpoint
LD <sub>50</sub> contact	µg/bee
LD <sub>50</sub> oral	µg/bee
LC <sub>50</sub> adult	µg/bee per day
NOEC development of hypopharyngeal glands	µg/bee per day
NOEC larvae	µg/larvae <sup>20</sup>
Indication of accumulative effects	Yes/no

Please see [Appendix O](#) for further details.

#### 6.1.2. Semi-field and field studies

Full details as to how to carry out semi-field and field studies and how to use them in risk assessment are provided in Appendix O. These studies are based largely on existing guidance (e.g. EPPO (2010) and (OECD, 2007));. However, various additions have been made to try to address the weaknesses highlighted in EFSA PPR Panel 2012a EFSA Panel on Plant Protection Products and their Residues (PPR) (2012a) for example increased replication to ensure that the studies have sufficient power to detect the required effect, clarification as to what are the primary (and secondary) assessment endpoints.

In carrying out semi-field and field studies it is important to ensure that adequate exposure has been achieved and it is therefore necessary to carry out residue studies to determine the residues in pollen and nectar in honey sacks and pollen sacks of bees entering the hive if the risk is caused by oral exposure and the residues on the bees entering the hive if the risk is caused by contact exposure (similar to procedures described in [Appendix G](#)).

### 6.2. Bumble bees effects studies

#### 6.2.1. Lower tier studies

Currently, validated test protocols are not available for bumble bees. However, it is considered feasible to conduct the acute oral and contact toxicity tests on adult bumble bees.

For the chronic and the larvae toxicity tests, it is proposed that the honey bee studies and associated endpoints be used as surrogates for bumble bees until internationally agreed and adopted guidelines are available for these tests.

<sup>20</sup> Please note that the risk assessment schemes consider the oral exposure of the larvae over the entire developmental period while the larvae are feeding. Therefore, the toxicological endpoint needs also be expressed as the sum of mass of the residue consumed by larvae during the entire testing period.

### 6.2.1.1. Adult oral and contact toxicity study

This should be carried out according to OECD 213 and 214 with specific adaptations to bumble bees.

**Endpoints from the laboratory studies**—the endpoints from the above studies should be collated as follows:

Toxicity study	Endpoint
LD <sub>50</sub> contact	µg/bumble bee
LD <sub>50</sub> oral	µg/bumble bee
LC <sub>50</sub> adult*	mg/kg—this should be converted to µg/bee per day
NOEC larvae*	µg/larvae
Indication of accumulative effects	Yes/no

\*Using the endpoints of the studies with honey bees as a surrogate for bumble bees.

Please see [Appendix P](#) for further details on the acute oral and contact toxicity studies.

### 6.2.2. Higher tier studies

Higher tier tests are required when concerns have not been adequately resolved at lower tiers. The choice and design of any higher tier study should be such that it addresses concerns highlighted at lower tiers. Owing to the lack of agreed guidelines, it is not possible to recommend a specific study; therefore, Appendix P. presents a range of possible studies that have been used. It is recognised that these need to be fully developed and validated, and therefore the guidance provided in Appendix P. is likely to develop as experience grows. In the development of the internationally agreed guideline, it is recommended that the following endpoints are covered.

1. E1: total reproductive output by bumble bee colonies;
2. E2: queen versus male production by bumble bee colonies;
3. E3: queen hibernation survival by bumble bees; (at the moment there are no ecotoxicological studies which have addressed this point);
4. E4: nest “founding” success the following spring by bumble bee queens (at the moment there are no ecotoxicological studies which have addressed this point).

It is proposed that the following higher tier studies should be considered until such time that internationally agreed guidelines are available. It should be noted that, whichever studies are carried out, it is important to link them to the SPGs (see [chapter 2](#)) and hence all stages as outlined above are covered at an appropriate exposure concentration.

#### 6.2.2.1. Study with microcolonies in laboratories conditions

This test is designed to study the effects of chronic exposure at environmental relevant concentration on colony survival, drones production and foraging behaviour (Mommaerts et al., 2010), (Laycock et al., 2012). Consequently, they can be used to detect effects on E1 and partly on E2 (only male production). This laboratory test is recommended as a second step of the risk assessment when an HQ or ETR is breached or the active substance indicates the potential for accumulative effects. The use of microcolonies in the risk assessment studies with bumble bees can be justified by the relatively low cost, the ease of use and the possibility of working with replicates under standardised conditions.

#### 6.2.2.2. Greenhouse or tunnel studies

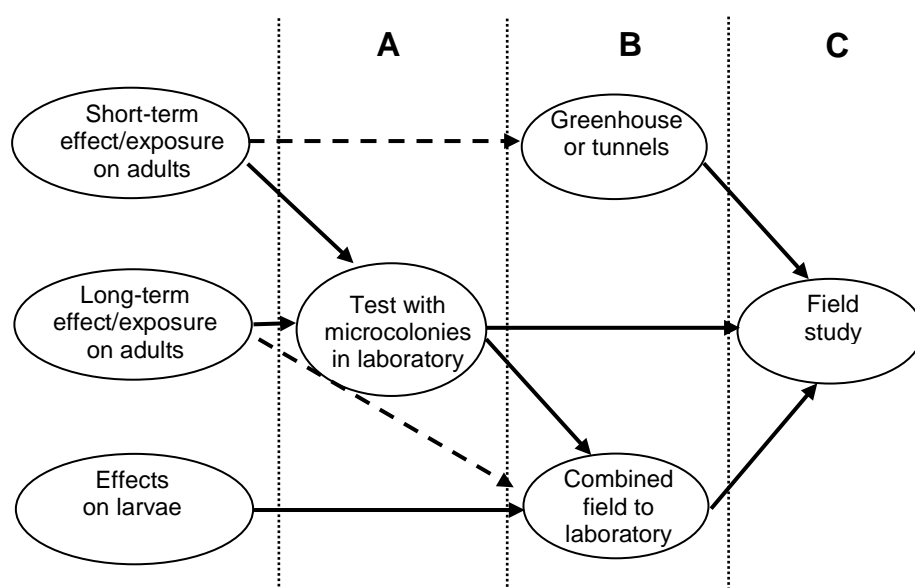
The OECD semi-field study for honey bees can be readily adapted to bumble bees. Owing to the limitations of semi-field tests (e.g. the restricted forage source and the limited capacity to detect long-term effects), as for honey bees, it is proposed that semi-field studies have a limited use in the risk assessment and decision-making process.

### 6.2.2.3. Combined field-to-laboratory studies

Bumble bee colony development and reproductive output can be studied with the protocols based on Whitehorn et al. (2012) and Gill et al. (2012). In Whitehorn et al. (2012), the phase of exposure takes place in controlled laboratory conditions, while the development of the colony takes place in field conditions. In Gill et al. (2012), the oral and contact exposure to two different compounds of freely flying and foraging bees was evaluated.

### 6.2.2.4. Field studies

The aim of these studies is to get more insight into the risks for bumble bee colonies under more realistic, field-related conditions. The number of such studies performed so far is very low (EFSA Panel on Plant Protection Products and their Residues (PPR), 2012a) and none completely addressed the endpoints suggested to meet the protection goal. As long as a new protocol to study the effect of pesticide on bumble bees is not available and validated, the combined field-to-laboratory studies should be used.



**Figure 14:** Schematic overview proposed for bumble bees of the different higher tier tests for the different concerns highlighted in the first tier studies. If there is more than one concern, the applicant should carry out the most comprehensive study, i.e. the study should be designed to address all the concerns raised at lower tiers. The level of realism of the test increased from A to C. The broken line indicates an optional way

## 6.3. Solitary bees effects studies

### 6.3.1. Lower tier studies

At the moment official test protocols are not available for solitary bees. However, it is feasible to conduct the acute oral and contact toxicity tests in adults of solitary bees.

For the chronic and the larvae toxicity tests, it is proposed that the honey bee studies and associated endpoints as surrogate for solitary bees until an internationally agreed and adopted guidelines are available for these tests.

#### 6.3.1.1. Adult oral and contact toxicity study

This should be carried out according to OECD 213 and 214 with specific adaptations to solitary bees.

**Endpoints from the laboratory studies** —the endpoints from the above studies should be collated as follows:

Toxicity study	Endpoint
LD <sub>50</sub> contact	µg/solitary bee
LD <sub>50</sub> oral	µg/solitary bee
LC <sub>50</sub> adult*	mg/kg—this should be converted to µg/bee per day
NOEClarvae*	µg/larvae
Indication of accumulative effects*	Yes/no

\*Using the endpoints of the studies with honey bees as a surrogate for solitary bees.

Please see [Appendix Q](#) for further details.

### 6.3.2. Higher tier studies

Higher tier tests are required when concerns have not been adequately addressed at lower tiers. The choice and design of any higher tier study should be such that it addresses concerns highlighted at lower tiers. Here, a range of possible tests available in literature up to now are proposed. They need to be fully developed and validated. In the development of the internationally agreed guideline, it is recommended that the following factors are covered:

1. E1: cell production rate;
2. E2: offspring production and sex ratio;
3. E3: progeny survival and post-emergence performances in the next spring;

It is proposed that the following higher tier studies should be considered until such time that internationally agreed guidelines are available. It should be noted that which ever studies are carried out that it is important to link them to the SPGs (see [chapter 2](#)) and hence all stages as outlined above, are covered at an appropriate exposure concentration.

#### 6.3.2.1. Study on larvae in higher tier laboratories conditions

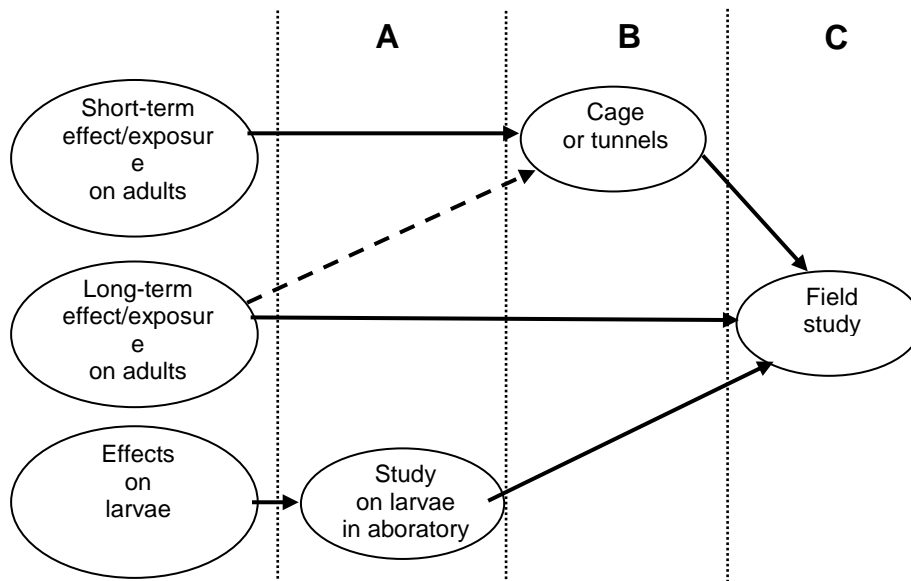
This test is designed to study the effects of pesticide to bee larvae at environmentally relevant concentration in laboratory conditions. This test is recommended when concerns on brood are highlighted at lower tiers using honey bees as surrogate. In this case the risk for solitary bees could be higher than *Apis mellifera* because, unlike honey bee larvae that feed primarily on secretions (brood food or royal jelly) from nurse bees, the larvae of solitary bees are exposed directly to pesticide.

#### 6.3.2.2. Tunnel or cage studies

A protocol mainly based on the study of Ladurner et al. (2008) is proposed. Foraging activity and parental investment of each nesting female are measured in this test.

#### 6.3.2.3. Field studies

Owing to the short foraging range of solitary bees, field tests can be easily feasible compared with honey bees. However, at the moment only one field study on solitary bees is available in the literature (Torchio, 1973).



**Figure 15:** Schematic overview proposed for bumble bees of the different higher tier tests for the different concerns highlighted in the first tier studies. If there are more than one concern, the applicant should carry out the most comprehensive study, i.e. the study should be designed to address all the concerns raised at lower tiers. The level of realism of the test increased from A to C. The broken line indicates an optional way

## 7. Trigger values

The risk assessment scheme and associated trigger values need to ensure that the protection goal (negligible effects on colonies; see [chapter 2](#)) is achieved at all levels of the tiered risk assessment.

In defining the SPGs reference has been made to the level of mortality that colonies next to a treated crop can sustain over a certain time period without undue harm (i.e. the colony will not be lost).

In order to determine if a PPP and its associated use pose an acceptable risk, and hence the SPG can be met, it is necessary to develop appropriate trigger values.

Currently, in risk assessments carried out under Regulation 1107/2009, an HQ, approach is used to determine whether the acute risk from a pesticide applied as a spray poses an ‘acceptable’<sup>21</sup> risk. An HQ is the ratio between the application rate in g/ha and the LD<sub>50</sub> oral or LD<sub>50</sub> contact in µg/bee, i.e.  $\text{g/ha} \div \text{LD}_{50}$ . If the resulting ratio is 50 or less, then the risk is deemed to be acceptable. A key issue to consider is whether a HQ of 50 or less is comparable to the protection goal.

The HQ trigger has been reviewed by Mineau et al. (2008) and Thompson and Thorbahn (2009). There are several limitations (see Appendix R. in EFSA Panel on Plant Protection Products and their Residues (PPR), 2012a) which make it difficult to link the HQ of 50 to the suggested protection goal of negligible effects on colonies. Therefore, an alternative method to derive trigger values is suggested in the current Guidance Document and described in Appendix M.

It was considered appropriate to use the same trigger values for solid formations as for spray formulations (see [Appendix M](#)).

The risk assessment scheme and associated trigger values enable an assessment that, if met, would protect  $x$  of sites (i.e. treated fields) where honey bee colonies are situated on the edge of treated fields. The trigger values are set so that an individual colony can tolerate an impact on foragers of a certain magnitude for a certain period of time (for negligible effects this is for example an increase of average daily mortality compared to controls by a factor of 1.5 for six days).

In order to calculate trigger values which should ensure that the protection goals are met, it was necessary to find information on background mortality of foragers under natural conditions. In the published literature only seven studies were found in which natural background levels of forager mortality could be derived. In five studies information was given on the forager mortality or on lifespan of foragers, and in two studies only the total lifespan of adult bees was given. In order to increase the dataset, these two studies were also included in the analysis and the forager lifespan was calculated assuming that the in-hive lifespan is 20 days. The average daily forager mortality rate ranged from 5.3% to 20.8%. The 10th percentile was 7.9% and the median value was 13% (see [Appendix K](#)). The conservativeness of the trigger value depends on the choice of the background mortality. The lower the number of natural background mortality that is chosen for derivation of the trigger value the more conservative will be the resulting trigger value. Given the limited dataset it is proposed to use the lowest background mortality rate found in literature to derive the trigger values. This may be refined further as soon as more studies become available. For the calculation of the trigger values and further details see [Appendix M](#).

If honey bee endpoints are used as a surrogate for bumble bees and solitary bees, then an extrapolation factor should be applied. A factor of 10 is considered appropriate according to Arena and Sgolastra (2013) (*in prep.*) A systematic review followed by a meta-analysis was performed to compare the

---

<sup>21</sup> The term ‘acceptable’ is not defined, i.e. it is not related to a level of mortality or sublethal effects.

sensitivity to pesticides of *Apis mellifera* with that of other bee species. A dataset including 18 different species (*Apis* spp., stingless bees, bumble bees and solitary bees), the contact LD<sub>50</sub> from 45 substances, the oral LD<sub>50</sub> from 19 substances and the LC<sub>50</sub> from three substances was built. The sensitivity ratio between the endpoint for the species *a* (*Apis mellifera*) and the species *s* (other than *Apis mellifera*) was calculated for a total of 145 case studies (a case study is defined as a unique pair combination of pesticide, endpoint and exposure for *Apis mellifera* and another bee species). A pesticide was included in the analysis if the same endpoints (LD<sub>50</sub> contact/oral or LC<sub>50</sub> values) were measured for honey bees and other bee species in the same study. Endpoints from different studies were included in the analysis if the test design was identical and observation of mortality was conducted at the same time intervals. The meta-analysis showed a high variability of sensitivity among bee species but in about the 95% of the cases the sensitivity ratio was below a factor of 10.

### The following trigger values are proposed for honey bees:

The trigger values for acute oral toxicity and chronic oral toxicity and the larvae are for ETRs (ratio of exposure and toxicity,  $ETR = \text{exposure}/\text{toxicity}$ ). The trigger value for acute contact toxicity are for HQs.  $HQ = \text{application rate (in g a.s./ha)}/\text{toxicity } (\mu\text{g a.s./bee})$ .

In order to conclude that the protection goal is met, the calculated HQ or ETR value needs to be lower than the suggested trigger value.

Acute oral toxicity (LD<sub>50</sub>):  $ETR < 0.2$

Acute contact toxicity (LD<sub>50</sub>):  $HQ$  (downwards spray)  $< 42$ ,  $HQ$  (upwards and sideward spray)  $< 85$

Chronic oral toxicity (LC<sub>50</sub>):  $ETR < 0.03$

Development of hypopharyngeal glands (NOEC):  $ETR < 1$

Larval toxicity (NOEC):  $ETR < 0.2$ .

The endpoint for development of HPGs is used as a measure of potential sublethal effects on brood care and ensuing adverse effects on brood. The endpoint for development of HPGs is based on a concentration that does not cause effects in the laboratory study compared with controls (NOEC). Therefore, the protection goal of negligible effects is achieved if the 90<sup>th</sup> percentile exposure estimate does not exceed the NOEC. Uncertainties remain with regard to quantification of effects on brood care. Ideally, such uncertainties should be quantified and translated into an assessment factor. Unfortunately, such data were not available and the trigger value should be revised in future when data become available.

The endpoint for larval toxicity is based on a concentration that does not cause any effects in the laboratory study compared with controls (NOEC). Therefore, the protection goal of negligible effects is achieved if the 90th percentile exposure estimate does not exceed the NOEC. However, there are uncertainties related to potential differences in sensitivity in honey bee subspecies and laboratory to field extrapolation. An assessment factor of 5 is proposed in order to account for these uncertainties (see [Appendix M](#)).

### The following trigger values are proposed for bumble bees:

Bumble bee workers have a longer flight span than honey bee workers and thus lower daily mortality rates. The trigger value calculation was based on a daily background mortality of 4.4% (see [Appendix K](#) on mortality rates). Bumble bee colonies are particularly susceptible to reduction in worker bee numbers because only large colonies produce queens (see Whitehorn et al., 2012). In order to account

for the higher susceptibility to worker losses and differences in sensitivity between different bumble bee species, it is suggested that an additional assessment factor of 5 be added to the trigger value.

Acute oral toxicity (LD<sub>50</sub>): ETR < 0.036

Acute contact toxicity (LD<sub>50</sub>): HQ (downwards spray) < 7, HQ (upwards and sideward spray) < 14

Chronic oral toxicity (LC<sub>50</sub>): ETR < 0.0048

Larval toxicity (NOEC): ETR < 0.2.

An additional assessment factor of 10 should be added to the ETR and HQ trigger values if the assessment relies on the endpoint from honey bees in order to account for potential differences in species sensitivity.

**The following trigger values are proposed for solitary bees:**

The trigger values for acute effects were calculated based on a daily background mortality of 5% (based on a flight span of 20 days for *Osmia* taken from Bosch et al. (2008)). An assessment factor of 5 is suggested in order to account for uncertainties related to potential differences in sensitivity among solitary bees.

Acute oral toxicity (LD<sub>50</sub>): ETR < 0.04

Acute contact toxicity (LD<sub>50</sub>): HQ (downwards spray) < 8, HQ (upwards and sideward spray) < 16

Chronic oral toxicity (LC<sub>50</sub>): ETR < 0.0054

Larval toxicity (NOEC): ETR < 0.2

An additional assessment factor of 10 should be added to the ETR and HQ trigger values if the assessment relies on the endpoint from honey bees in order to account for potential differences in species sensitivity.

Please note that the natural background mortality has a strong influence on the proposed trigger values for acute toxicity (contact and oral) and chronic oral toxicity. The proposed trigger values are based on the lowest values of background mortality found in literature as a precautionary approach because of the low number of studies available. The trigger values include assessment factors to account for uncertainties related to laboratory to field extrapolation and potential differences in species sensitivity. These uncertainties could be reduced if more data become available and the trigger values may be refined in the future.

## 8. Mixture toxicity and toxicity of formulated products with two or more active substances

The following parts of this section are from either the Guidance Document on risk assessment for birds and mammals (EFSA, 2009) or the scientific opinion on the science behind the development of a risk assessment of plant protection products on bees (EFSA Panel on Plant Protection Products and their Residues (PPR), 2012a). In those two documents, in particular in the bee opinion, more background information is provided.

In a recent review for the EC (Kortenkamp et al., 2009), the use of the concentration addition model was proposed as the concept of mixture toxicity that is most relevant for hazard characterisation and ultimately can be integrated into the legislative process for risk management purposes. The use of the concentration addition has also been discussed by Verbruggen and van den Brink (2010). There are two reasons that make the use of this model concept attractive for policy makers. First, the model concept is generally more conservative than the concept of response addition. Nevertheless, the magnitude of the differences at low levels of exposure between the two models is usually small and, hence, the outcome will not be overly conservative. A second reason for the use of concentration addition is that the model concept can make use of existing data such as a NOEC, EC<sub>10</sub> or EC<sub>50</sub> by applying the concept of toxic units (TUs).

The concept of TUs has been recently reviewed by the three non-food committees of the EC (the Scientific Committee on Health and Environmental Risks (SCHER), the Scientific Committee on Emerging and Newly Identified Health Risks (SCENHIR) and the Scientific Committee on Consumer Safety (SCCS)) which defined TUs as “the ratio between the concentration of a mixture component and its toxicological acute (e.g. LC<sub>50</sub>) or chronic (e.g. long-term NOEC) endpoint”. In addition, the toxic unit of a mixture (TUM) has been defined as the sum of TUs of each individual chemical of that mixture. The committees also noted that the TUs concept only refers to a specific organism representative of a group of organisms ecologically or taxonomically relevant for the ecosystem (e.g. algae, daphnids and fish for the freshwater ecosystem) but not to the ecosystem as a whole (SCHER/SCENHIR/SCCS, 2011).

### *Concentration addition (CA)*

The following equation can be used for deriving a surrogate ED<sub>x</sub>, EC<sub>x</sub>, NOEC or NOEL value for a mixture of active substances with known toxicity assuming dose additivity:

$$1/EC_x \text{ (mix) or } 1/NOEC \text{ (mix)} = \left( \sum_i \frac{X(a.s._i)}{EC_x \text{ or } NOEC(a.s._i)} \right)$$

Where:

$X(a.s._i)$  = fraction of active substance [ $i$ ] in the mixture (please note that the sum  $\sum X(a.s._i)$  must be 1)

$EC_x$  or  $NOEC(a.s._i)$  = toxicity value for active substance [ $i$ ] (for the same endpoint).

Where the toxicity value of a formulated product with more than one active substance is available, this value should be compared with the predicted mixture toxicity assuming dose additivity. A different form of the equation is used.

$$\sum_i \frac{X(a.s._i)}{EC_x \text{ or } NOEC(a.s._i)} = \frac{1}{EC_x \text{ or } NOEC(mix)}$$

$X(a.s._i)$  = fraction of active substance [ $i$ ] in the mixture

$EC_x$  or  $NOEC(a.s._i)$  = acute toxicity value for active substance [ $i$ ]

$EC_x$  or NOEC(mix) = measured acute toxicity value for the mixture.

A greater value on the right side of the equation indicates that the formulation is more toxic than predicted from the toxicity of the individual components (active substances and co-formulants of known toxicity). This may be due to, for example, further toxic co-formulants, toxicokinetic interaction or synergism/potential of effect. It may also reflect the inherent variability of toxicity testing. In all these cases, the use of the  $EC_{50}$  for the formulation (together with appropriate exposure estimates; see Step 4) is recommended for the first tier assessment, because it cannot be excluded that such effects would also occur after exposure of animals to residues in the environment.

If endpoints are available from both, active substance and formulation studies then the lower endpoint should be used in the risk assessment. Dismissing the  $EC_{50}$  of the formulation from the risk assessment would only be acceptable at a Higher Tier if any observed greater toxicity in the test could be clearly and unambiguously ascribed to a factor that would not be relevant under environmental exposure conditions.

If, in contrast, the measured toxicity of a formulation is lower than predicted, the predicted mixture toxicity should be used in the first-tier risk assessment, together with appropriate exposure estimates.

For the first tier it is assumed that all peaks will occur at the same moment and are not separated in time. In case the trigger value is not met in higher tiers the predicted exposure patterns can be taken into account (see for example calculations Table 4).

**Table 4:** Example for a mixture of two compounds (all concentrations in  $\mu\text{g/L}$ ). Values printed in bold are above the trigger value of 0.1 and additional risk assessment should be considered

Days	1	2	3	4	5	6	7	8
Concentration compound A	0.9	0.8	0.7	0.6	0.5	0.4	0.3	0.2
Concentration compound B	0	0	0	2.3	1.2	0.6	0.3	0.1
Toxicity compound A	10	10	10	10	10	10	10	10
Toxicity compound B	8	8	8	8	8	8	8	8
Toxicity mixture	10	10	10	8.41	8.59	8.8	9	9.33
TER mixture	0.09	0.08	0.07	<b>0.34</b>	<b>0.19</b>	<b>0.11</b>	0.07	0.03

## 9. Risk mitigation options

### 9.1. Risk mitigation for bees

If a risk to honey bees, bumble bees and/or solitary bees is predicted, then the risk may be refined with substance-specific data, for example residue trials and/or bee toxicity studies (see chapters 5 and 0 for further details). An alternative way to refine the risk is to reduce the exposure via the use of risk mitigation measures. Reference is made to such measures in the exposure flow charts in chapter 5 and its associated appendices. The aim of this chapter is to highlight what risk mitigation measures are possible and what issues need to be considered when developing such measures.

Currently the only harmonised risk mitigation phrase aimed at reducing the exposure and hence risk to bees is the following SPe8 from Annex V of 1999/45/EC:<sup>22</sup>

*Dangerous to bees./To protect bees and other pollinating insects do not apply on flowering crops./Do not use where bees are actively foraging./Remove or cover beehives during application and for (state time) after treatment./Do not apply when flowering weeds are present./Remove weeds before flowering./Do not apply before (state time).*

This phrase, or at least parts of it, is considered to cover risk mitigation for honey bees,<sup>23</sup> bumble bees and solitary bees. It is, however, potentially more appropriate to mitigate risks from spray applications rather than those from applications of soils, i.e. granules, seed treatments, etc. Outlined below are a few points regarding specific phrases within the SPe8 phrase:

- It may be appropriate to add the wording ‘... except as directed on [crop]’ following ‘.. crop plants when in flower,’ where use is on several crops—but use on only some of these crops poses a risk to bees.
- There is uncertainty regarding the practicality of the phrase ‘Remove or cover beehives during application and for [state time] after treatment’, as it may result in an impact on honey bee colonies, for example from overheating. There are also practical difficulties as beekeepers may not live or be in the vicinity of their hives at the time of application. This risk mitigation measure is, of course, not relevant for bumble bees and solitary bees.
- The phrase ‘Do not apply before (state time)’ is potentially unclear, and hence clarification on the label would be required whether ‘time’ implies time of day, time of year or time in relation to crop development. It should also be noted bumble bees and solitary bees may forage at different times of the day and hence this phrase may protect one group but not the others.
- The recommendation ‘remove weeds before flowering’ is likely to have undesired side effects such as removing a source of nectar and pollen, which in turn may impact on honey bees, solitary bees and bumble bees. Further data would be needed to determine the wider impact of such risk mitigation. It is therefore, recommended that MSs consider the wider implications of this risk mitigation measure before implementation on product labels.

In addition to the above points, the SPe8 phrase does not cover all exposure scenarios, e.g. adjacent crops. Therefore, if risks are highlighted as part of the risk assessment process, then it may be necessary to develop bespoke risk mitigation phrases to address the concern(s) highlighted. The

<sup>22</sup> This phrase is still relevant under 1107/2009/EC (see Article 65.1).

<sup>23</sup> Feral honey bees have not been considered specifically in the risk assessment schemes. However, feral bees can be an important source of pollination as well as honey bees. It is considered that the following phrases should protect not only honey bees from specific colonies but also feral honey bees.

precise wording of any phrase needs to be clarified at MS level and it should be noted that these phrases should be notified to the EC if they are used for authorisations (1107/2009, Article 65.3).

### 9.1.1. Important factors to consider when developing risk mitigation measures

Outlined below are some issues that should be considered when developing such mitigation measures:

- Ensure that all risk mitigation phrases are workable and enforceable.
- Always ensure that the risk mitigation phrase is seen by the relevant person. This is usually straightforward for spray formulations, where the risk mitigation can be stated on the product label. However, it is more complicated for treated seeds. For measures relevant to the sowing process of treated seed, the risk mitigation phrases should be on the bag with treated seed or accompanying document and not only on the seed treatment product label; see 1107/2009, Article 49.4.
- For bee-attractive succeeding crops, these risk mitigation phrases should accompany plants that are grown from treated seed and then sold on to an end-user.

### 9.1.2. Definitions that may be useful in determining when risk mitigation can be used

In developing risk mitigation measures, it is important to define key elements such as flowering. Presented below are some suggestions regarding possible definitions of flowering, MSs may wish to develop their own definitions.

*Definition flowering (bloom)*

Flowers in which the stamen or pistils are visible.

A crop is considered a flowering crop when the first flowers are open (BBCH 60)

*Definition flowering crop—orchard*

An orchard is considered a flowering crop when more than 1% of the flowers in an orchard are flowering.

*Definition flowering crop—field crops*

The crop is considered a flowering crop when more than two plants (crop and/or weed plants) per square metre are flowering.

*Definition flowering crop—flower bulbs/bulb flowers*

A crop is in flower when more than 1 % of the plants in a field is flowering. In Dutch agricultural practice, this means that a crop is considered to be flowering when more than two plants per linear metre of a field are flowering.

*Definition flowering weeds*

When there are five or more open weed blooms per m<sup>2</sup> on average for the area being measured.

### 9.1.3. Possible risk mitigation measures and associated phrases

Presented below are risk mitigation measures and associated phrases for the exposure scenarios considered in the exposure and risk assessment chapters. Please note that no assessment of the risk to bees from honey dew is proposed in the current Guidance Document because the available information was not sufficient to produce a robust risk assessment scheme for this exposure route. However, recommendations for risk mitigation were included below which MSs could follow in case that there are concerns about risk to bees from exposure to honey dew:

- a. risk from spray applications
  - i. mitigating the risk from the application to the treated crop

- ii. mitigating the risk from the application to treated weeds in the field
  - iii. mitigating the risk from bees foraging the field margin
  - iv. mitigating the risk from bees foraging adjacent crops
  - v. mitigating the risk from succeeding or following crops
  - vi. mitigation the risk from aphid (or other insects) honeydew
  - vii. mitigating the risk from guttation
  - viii. mitigating the risk from surface water
  - ix. mitigating the risk from soil
  - x. mitigating the risk from drinking water from puddles
- b. risk from solid applications
- i. mitigating the risk from the application to the treated crop
  - ii. mitigating the risk from the application to treated weeds in the field
  - iii. mitigating the risk from bees foraging the field margin
  - iv. mitigating the risk from bees foraging adjacent crops
  - v. mitigating the risk from bees foraging succeeding or following crops
  - vi. mitigation the risk from aphid (or other insects) honey dew
  - vii. mitigating the risk from guttation
  - viii. mitigating the risk from surface water
  - ix. mitigating the risk from soil
  - x. mitigating the risk from drinking water from puddles.

#### 9.1.4. Mitigating the risk from spray applications

##### 9.1.4.1. Mitigating the risk from the application to the treated crop

If there is a direct risk via spray application on a flowering crop, all or parts of the harmonised SPe8 risk mitigation phrase presented above may be appropriate.

##### 9.1.4.2. Mitigating the risk from the application to treated weeds in the field

The SPe8 phrase includes a reference to removing weeds; therefore, it may be possible to use this phrase if a risk to bees foraging treated weeds is predicted. However, the above point regarding possible adverse effects on biodiversity should be noted. Alternatively, the phrase “do not use where bees are actively foraging” also addresses this risk and permits flowering weeds to be left in place. For permanent crops, e.g. vines and orchards, it may be possible to restrict use to situations where flowering weeds are unlikely, for example via the use of the following French phrase:

*Restrict the use of the preparation to vineyards/orchards with grass ground covers or bare soil.*

##### 9.1.4.3. Mitigating the risk from bees foraging the field margin

If a risk is predicted from spray application on to a field margin, then it may be appropriate to consider the use of drift reducing measures, for example:

*Dangerous to bees./To protect bees and other pollinating insects, [specify risk mitigation measure, e.g. 90 % drift reducing spray nozzles, a buffer zone of x m, ...] must be used.*

*Do not apply when field margins are flowering*

##### 9.1.4.4. Mitigating the risk from bees foraging adjacent crops

If a risk is predicted from spray application on to an adjacent crop, then it may be appropriate to consider the use of drift reducing measures, for example:

*Dangerous to bees./To protect bees and other pollinating insects, [specify risk mitigation measure, e.g. 90 % drift reducing spray nozzles, a buffer zone of x m, ...] must be used.*

*Do not apply when the adjacent crops are flowering*

9.1.4.5. Mitigating the risk from succeeding or following crops

If a risk to succeeding non-permanent or following crops is predicted, it may be appropriate to propose a waiting period for bee-attractive succeeding crops and hence a phrase along the following lines may be used:

*Due to the risk to bees, bee-attractive crops should not be sown or planted within a period of [x] after [application/sowing/planting in the field].*

It is not possible to mitigate the risk from permanent succeeding crops.

9.1.4.6. Mitigation the risk from aphid (or other insects) honeydew

If there is concern about exposure to honeydew (based on information on use of a substance and substance properties), it may be appropriate to mitigate the risk via the use of the SPe8 phrase and hence prevent spraying when bees are actively foraging the crop. Alternatively, it may be appropriate to recommend that aphids are controlled prior to the formation of aphid honeydew. However, this may lead to an increase in insecticide use which in turn may lead to other risks to bees.

9.1.4.7. Mitigating the risk from guttation

From the available information, it is evident that effects on bees from exposure to guttation water have only been observed when no alternative sources of water were in the vicinity of the hive. The provision of water could therefore mitigate the risk.

The distance of the colony to the field where guttation fluid occurs is also of importance. Guttation fluid was observed very frequently in grasses and in the vegetation outside the treated crop. Such vegetation could be more attractive to bees to collect guttation water than the crop plants. Furthermore, the available data suggest that bees prefer permanent water sources to guttation droplets. Therefore, a vegetated buffer strip and permanent water bodies in the vicinity of the field may mitigate the risk from guttation water.

In light of the above, it could be an option to restrict uses (e.g. planting of seed treated crops) to fields where permanent water bodies such as ponds or streams are in the close vicinity. However, the available information is not sufficient to give an recommendation on the minimum distance to the next permanent water body that is needed to avoid that bees use guttation droplets from treated fields. Research would be needed to investigate the distance at which permanent sources of water are preferred over guttation droplets collected in the field.

Overall it is concluded that more information is needed to decide on the efficiency of different risk mitigation options and that this should be determined at MS level.

9.1.4.8. Mitigating the risk from surface water

If a risk is predicted from bees drinking from contaminated surface water then it is possible to mitigate the risk via reducing the PEC<sub>sw</sub> via further FOCUS modelling and/or risk mitigation options outlined in the FOCUS Landscape and Mitigation Report.<sup>24</sup>

---

<sup>24</sup> FOCUS (2007). "Landscape And Mitigation Factors In Aquatic Risk Assessment. Volume 1. Extended Summary and Recommendations". Report of the FOCUS Working Group on Landscape and Mitigation Factors in Ecological Risk Assessment, EC Document Reference SANCO/10422/2005 v2.0. 169 pp.

#### 9.1.4.9. Mitigating the risk from soil

Whilst it is acknowledged that exposure from residues in the soil to bees that nest in the ground is important, this is not covered in the risk assessment schemes.

#### 9.1.4.10. Mitigating the risk from drinking water from puddles

If a risk from the consumption of water from puddles is predicted, then it is not possible to suggest risk mitigation which will work in every Member State. It is also unknown to what extent the risk can be mitigated.

### 9.1.5. Mitigating the risk from solid applications

#### 9.1.5.1. Mitigating the risk from the application to the treated crop

If a risk is predicted due to residues of the active substance and/or metabolites in nectar and pollen, it may be possible to mitigate the risk to honey bees by advising beekeepers that the crop has been grown from treated seed. This may be problematic owing to the foraging range of honey bees, location of colonies in relation to fields drilled with treated seed, etc. This will not mitigate the risk to other bees.

#### 9.1.5.2. Mitigating the risk from bees foraging the field margin

If a risk from dust has been predicted, then it may be possible to recommend that the treated seed should be of a certain quality and that drilling of treated seed only occurs under certain conditions. For example, the following, or similar, phrases could appear on the label:

*... to reduce dust formation on the seed include sentence on seed treatment product label:*

*Treated seed should have a maximum dust level of [e.g. 0.75] g dust per [e.g. 100 000 seeds] (Heubach method).*

In order to further reduce dust drift during sowing it may be appropriate to include a phrase along the following lines:

*Before sowing:*

*Do not transfer dust from bag into sowing machine.*

*During sowing:*

*Only drill seed when the wind speed is less than 12 km/hour.*

*When using a pneumatic sowing machine, deflectors must lead the air stream towards or into the ground [or other recommendations relevant for the specific crop/sowing machine].*

*Do not apply when the field margins are flowering*

#### 9.1.5.3. Mitigating the risk from bees foraging adjacent crops

If a risk from dust has been predicted, then it may be possible to recommend that the treated seed should be of a certain quality and that drilling of treated seed only occurs under certain conditions. For example, the following, or similar, phrases could appear on the label:

*... to reduce dust formation on the seed include sentence on seed treatment product label:*

*Treated seed should have a maximum dust level of [e.g. 0.75] g dust per [e.g.100 000 seeds] (Heubach method).*

In order to further reduce dust drift during sowing it may be appropriate to include a phrase along the following lines:

*Before sowing:*

*Do not transfer dust from bag into sowing machine*

*During sowing:*

*Only drill seed when the wind speed is less than 12 km/hour.*

*When using a pneumatic sowing machine, deflectors must lead the air stream towards or into the ground [or other recommendations relevant for the specific crop/sowing machine].*

*Do not apply when the adjacent crops are flowering.*

#### 9.1.5.4. Mitigating the risk from bees foraging succeeding or following crops

If a risk to succeeding or following crops is predicted, it may be appropriate to propose a waiting period for bee-attractive succeeding crops and hence a phrase along the following lines may be used:

*Due to the risk to bees, bee-attractive crops should not be sown or planted within a period of [x] after [application/sowing/planting in the field].*

It is not possible to mitigate the risk from permanent succeeding crops.

#### 9.1.5.5. Mitigating the risk from aphid (or other insect) honeydew

See section 11.1.4.6 above.

#### 9.1.5.6. Mitigating the risk from guttation

See section 11.1.4.7 above.

#### 9.1.5.7. Mitigating the risk from contaminated surface water

See section 11.1.4.8 above.

#### 9.1.5.8. Mitigating the risk from contaminated soil

Whilst it is acknowledged that exposure from residues in the soil to bees that nest in the ground is important, this is not covered in the risk assessment schemes.

#### 9.1.5.9. Mitigating the risk from drinking water from puddles

If a risk from the consumption of water from puddles is predicted, then it is not possible to suggest risk mitigation which will work in every Member State. It is also unknown to what extent the risk can be mitigated.

## 10. Sublethal effects

During the public consultation in 2012, many comments were passed regarding the lack of consideration of sublethal effects. After the consultation period, the Working Group (WG) revisited this issue and considered that currently it was not possible to consider sublethal effects in the risk assessment schemes; the reasons for this are as follows:

- There is currently a lack of standardised first tier laboratory studies designed to assess sublethal effects that are directly relevant to effects at the colony level or field scale. (It is acknowledged that the WG is proposing using non-standardised and un-adopted guidelines to assess the chronic toxicity to adults and larvae; however, the proposed laboratory guidelines are based on established draft guidelines and the parameter measured (i.e. mortality) is directly relevant to colony development and survival.)
- It is acknowledged that sublethal effects can be observed in the acute oral and contact studies as well as the chronic study. However, these effects are difficult to assess accurately as small cages are used where bees cannot move very much, fly or perform other tasks. As these studies are carried out in the dark and moved to the light for observations then light may cause additional effects that may compound interpretation of any sublethal effects, i.e. effects seen may be a result of the test design rather than the effect of the test compound. In addition, there is a lack of information regarding the relevance of the effects at the field scale and whether they would impact on the specific protection goals. For example, if excessive cleaning is observed in an acute contact study will the same effect occur under field conditions? Will cleaning be increased as a result of the artificiality of the test conditions or will it be in the same proportion? It is arguable that the confined nature and the unrealistic nature of the application mean that the proportion could be greater and therefore any risk assessment based on this endpoint could be overly protective. Conversely, it could be argued that the confined nature and the fact that the bees are held in the dark may lead to cleaning being lower than under field conditions. The key issue is that there is uncertainty regarding interpretation and hence use of this type of endpoint.
- Related to the above, there was concern regarding how to assess sublethal effects seen in the laboratory studies. For example, if excessive cleaning along with trembling were observed how should this be assessed in higher tier effects or exposure studies? Currently, the only studies that are available are semi-field and field studies and these would consequently be triggered every time a sublethal effect was observed in a laboratory study.

In the draft Guidance Document that went out for public consultation, a homing study was included. The aim of this study was to assess whether bees were adversely affected by sublethal levels of the pesticide so that they did not return to the colony. Following the public consultation, this study was reconsidered by the WG. As a result of this reconsideration, the WG concluded that a homing study, or a variation of it, could provide useful information on a range of sublethal parameters,<sup>25</sup> and in particular could provide information on return rates of foragers. However, there were concerns regarding interpretation and use of the data from this type of study in a regulatory risk assessment. In particular, in order to adequately determine whether the SPGs would be met, information on the proportion of foragers exposed in a normal colony would be needed for a comparison with those not returning from the homing study.

In addition, there were concerns relating the exposure element of the SPG. The risk assessment outlined in chapter 3 is based on the combination of the SPGs as described in chapter 2 and the exposure assessment goal as described in chapter 2. This exposure assessment goal considers the statistical population of all hives located at the edge of treated fields. The basis for this was that incidents caused by both spray and dust were reported for hives next to treated fields. The homing study considers effects on foragers that forage at a long distance (e.g. more than one kilometre) from

---

<sup>25</sup> For example, coordination, memory and orientation as well as potential sublethal effects on the physiology of bees (e.g. the respiratory system (recent publication on the subject), the circulatory system (haemolymph)).

the treated field. So a standard field study is unlikely to be useful in the context of an exposure assessment goal based on hives at the edges of treated fields, e.g. a 90th percentile case for exposure of all hives at the edges of treated fields is likely to occur in an area with a high density of fields treated with the substance considered. Such an area is unlikely to be a 90th percentile case for foragers collecting nectar at, for example, more than one kilometre distance. When considering the homing study, it seems most appropriate to base the exposure assessment goal on the statistical population of all hives in the area of use of the substance. So then the goal would be to assess the 90th percentile case of all these hives. Such a 90th percentile case hive is likely to be located at distance of about one kilometre of an attractive treated field with few alternative foraging possibilities. The exposure assessment procedure for this alternative exposure assessment goal could be developed in future.

The WG did consider a variety of ways to try to address the potential risk from sublethal effects, namely:

- Base the chronic assessment on the NOEC (or EC<sub>10</sub> or EC<sub>20</sub>) rather than the LC<sub>50</sub>. It was felt that, whilst relatively straightforward to do for the 10-day chronic study, this would lead to an overly precautionary risk assessment, as it would be assuming that **all** sublethal effects are directly related to effects in the field. If this approach were adopted, then the trigger value would need to be adjusted so that it would be related to the specific protection goal. In order to do this, information would be required on the relevance not only of the sublethal effect to the survival and development of the colony at field level but also of the proportion of bees exhibiting such symptoms.
- Use of biomarkers was highlighted in the Opinion of the EFSA Panel on Plant Protection Products and their Residues (PPR) (2012a) however, it was felt that this area required further research before incorporating it in to regulatory risk assessment.
- Consideration of sublethal effects that do not result in the death of the bee. It was considered that if a bee exhibited sublethal effects and then later died, then these sublethal effects were less of a concern than if the bee exhibited those symptoms to the end of the study. This would require bees in the laboratory to be marked and monitored carefully throughout. The feasibility of linking any possible endpoint to the SPGs needs further work.

For the above reasons, the WG proposes that the risk assessment should focus on acute and chronic effects on adults and larvae. However, it should be noted that none of the above implies that the WG does not consider that sublethal effects are not important and could play a role in the SPGs not being met. What it means is that currently appropriate regulatory studies that are linked to key relevant sublethal endpoints via an appropriate risk assessment (including trigger values linked to SPGs) are not available to assess them appropriately. It should be noted that in Appendix W, information on sublethal effects is requested. Whilst not currently used in the risk assessments, it is considered that this information should be collected and hence could prevent the need for retesting or carrying out additional studies once a methodology for dealing with sublethal effects has been developed.

There is further consideration of the potential impact of this in the assessment of conservatism (see [Appendix W](#)). The WG highlights this issue as a key research need.

**APPENDICES**

Name	Appendix Title
Appendix A.	NOMENCLATURE FOR EFFECT SIZES
Appendix B.	PROTECTION GOALS
Appendix C.	RELEVANCE OF DUST FOR TREATED SEEDS
Appendix D.	ATTRACTIVITY OF AGRICULTURAL CROPS TO HONEY BEES FOR THE COLLECTION OF NECTAR AND/OR POLLEN
Appendix E.	LANDSCAPE-LEVEL EXPOSURE ASSESSMENT OF THE AVERAGE CONCENTRATION ENTERING THE HIVE
Appendix F.	PESTICIDE RESIDUE LEVELS IN NECTAR AND POLLEN AND THE RESIDUE UNITE DOSES (RUDs)
Appendix G.	PROTOCOL FOR PERFORMING FIELD STUDIES FOR HIGHER EXPOSURE TIERS
Appendix H.	ASSESSMENT OF SPRAY DRIFT AND DUST DRIFT DEPOSITION ONTO FIELD MARGINS AND ADJACENT FIELDS
Appendix I.	ASSESSMENT OF THE PERCENTILE OF A SUBPOPULATION THAT CORRESPONDS TO A PRESCRIBED PERCENTILE OF THE TOTAL POPULATION
Appendix J.	SHORTCUT VALUES FOR THE ESTIMATION OF THE ORAL EXPOSURE VIA NECTAR AND POLLEN
Appendix K.	LITERATURE REVIEW ON DAILY MORTALITY RATE
Appendix L.	USE OF HQ AND ETR APPROACH FOR SOILD FORMULATIONS
Appendix M.	TRIGGER VALUES
Appendix N.	EXPOSURE ASSESSMENT FOR BEES FOR NECTAR AND POLLEN ENTERING THE HIVE
Appendix O.	EFFECT STUDIES-PROTOCOLS, GUIDANCE AND GUIDELINES FOR HONEY BEE, BUMBLE BEE AND SOLITARY BEE
Appendix P.	TEST PROTOCOLS FOR BUMBLE BEES ( <i>BOMBUS TERRESTRIS</i> )
Appendix Q.	TEST PROTOCOLS SOLITARY BEES ( <i>OSMIA CORNUTA</i> AND <i>OSMIA BICORNIS</i> = <i>O. RUFA</i> )
Appendix R.	TEST CROPS TO BE USED
Appendix S.	REFINEMENT OPTION FOR CROP SPECIFIC SUGAR CONTENT
Appendix T.	BACKGROUND TO THE EXPOSURE ESTIMATES AND TRIGGER VALUES USED IN THE RISK ASSESSMENT FOR GUTTATION
Appendix U.	TEST PROTOCOLS TO ASSESS THE EFFECTS OF PESTICIDES IN GUTTATIONS ON HONEY BEES
Appendix V.	ASSESSMENT OF UNCERTAINTY
Appendix W.	ILLUSTRATIVE SCHEME FOR ASSESSMENT OF SUBLETHAL EFFECTS
Appendix X.	INVENTORY OF EXPOSURE DEPOSITION FACTORS (FDEP) TO BE USED FOR THE EXPOSURE

## Appendix A. NOMENCLATURE FOR EFFECT SIZES

Specific protection goals (SPGs) have been formulated based on ecosystem services in accordance with the methodology outlined in the scientific opinion of the EFSA (EFSA Panel on Plant Protection Products and their Residues (PPR), 2010). With respect to honey bees, it is suggested to define the attributes to protect as survival and development of colonies and effects on larvae and behaviour as listed in regulation (EC) No 1107/2009. In addition, abundance/biomass and reproduction were also suggested because of their importance for the development and long-term survival of colonies. Pollination, hive products (for honey bees only) and biodiversity (specifically addressed under genetic resources and cultural services) were identified as relevant ecosystem services.

The viability of each colony, the pollination services it provides and its yield of hive products all depend on the colony's strength and, in particular, on the number of individuals it contains. It is therefore proposed to relate protection goals specifically to colony strength, which is defined operationally as the number of bees it contains, or colony size.

Based on expert judgement, the following nomenclature was defined for the magnitudes of detrimental impacts on colony, or 'effect sizes'.

Effect	Magnitude (reduction in colony size)
Large	> 35 %
Medium	15 % to 35 %
Small	7 % to 15 %
Negligible	3.5 % to 7 %

The variability in sizes among colonies prohibited defining effect sizes in terms of absolute reductions in the numbers of bees in a colony. Experts in the working group unanimously agreed that a proportional reduction in colony size of greater than one-third would be likely to compromise the viability, pollinating capability and yield of any colony; this consideration was used to define an effect as 'large'. The magnitude of a negligible effect was defined with similar regard to biological considerations and also by reference to the potential for experimental detection, because a negligible effect must be statistically distinguishable from 'small effects'. The intermediate effect sizes were then defined arbitrarily at even intervals in the range between 'large' and 'negligible'.

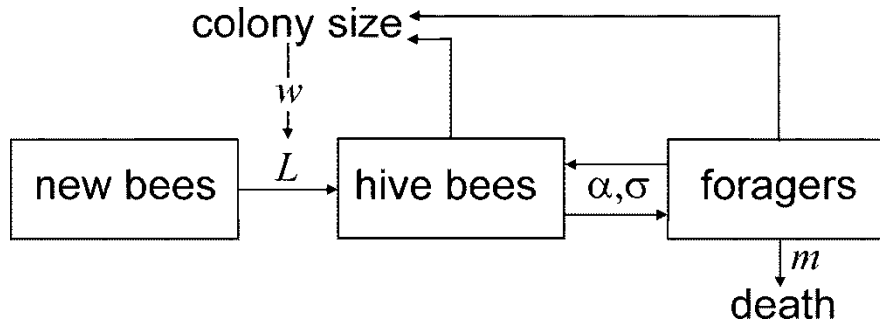
These effect sizes will be used to refer exclusively to impacts on colony size because (as will be shown below) other endpoints, such as mortality rates, may have quite different degrees of biological sensitivity. For example, a 35% change in mortality rates relative to background levels will have a relatively small impact on colony size (see analysis of model of Khoury et al. (2011), below) and would not be similarly considered a large effect. Correspondences will sometimes arise (e.g. the overall rate of background mortality among adult bees is around 3.5%; Khoury et al. assume 15.4% mortality among foragers and 25 % of adults are foragers, which implies that the overall rate is  $15.4 \times 0.25 \approx 3.5\%$ ), but these are coincidental and will not arise across the broad range of effect sizes. The same reasoning means that similar non-correspondences are likely to apply to sublethal endpoints, such as behavioural aspects of performance or fecundity, except in so far as impacts on them cause proportional effects on colony size. However, it will be appropriate in many cases to use the terms (i.e. 'large', 'medium', etc.) to refer to effects on components of colony size, which are delineated by life stages. For example, a 35% reduction in the number of brood in a colony is appropriately referred to as a large impact because it is likely to translate eventually into a similar effect on overall colony size.

The effect sizes defined above have been defined principally by reference to honey bee colonies, but in the case of non-*Apis* bees, they will refer similar to colony-level impacts (other social bees, such as bumble bees) or to population sizes (solitary bees).

In reality, the detrimental effects of pesticides on colony size will be mediated through either mortality or fecundity or both. The effects of pesticides on fecundity are not yet well understood and cannot be properly explored here. However, it is possible to theoretically interrelate effect sizes and mortality by reference to the model of colony dynamics proposed by Khoury et al. (2011). The model of Khoury et al. (2011) is focused on the effects of lifespan and mortality rates of forager bees on colony growth. Values for its parameters can be estimated from published observations; predictions and the behaviour of the model are validated with the experimental data of Rueppell et al. (2009), although the key predictions about the relationship between colony growth and forager mortality are not yet experimentally tested. As calibrated by Henry et al. (2012a), the model is applicable for colonies in autumn and winter, but it can also be calibrated for colonies in spring and summer (Cresswell and Thompson, 2012); (Henry et al., 2012b). According to these solutions to the model, autumn colonies are susceptible to decline caused by increased mortality of foragers (e.g. due to pesticide-induced navigation failure) but colonies in spring/summer are not.

*A theoretical basis for the magnitudes of large, small and negligible effects based on the model of Khoury et al. (2011)*

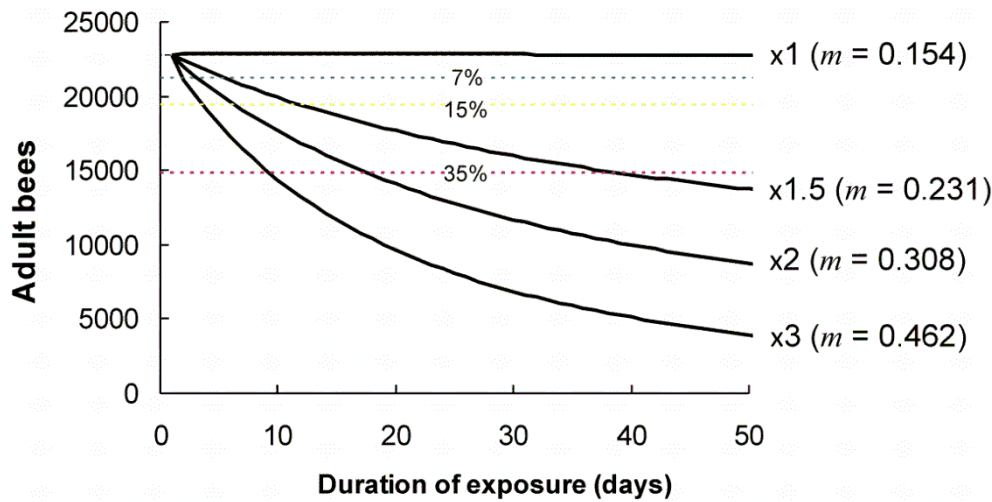
In the honey bee colony, the development of newly hatched adult workers follows a consistent and well-understood pathway. The newly emerged adults are first hive bees, which undertake various duties such as feeding larvae, comb building and cleaning. After a period, hive bees progress to join the workforce of foragers and they normally continue in this role until death. In cases where there is an excess of foragers, bees can reverse their development and return to duties in the hive. The fundamental biology associated with this division of labour can be described mathematically by a simple model (Khoury et al., 2011; Figure A1).



**Figure A1:** A simple description of the distribution of adult workers in a honey bee colony among stages of behavioural development (boxes: new bees, hive bees, foragers). Linking arrows indicate the possible pathways for progression and the nearby italicised parameters govern the daily rates of each transition

Thus, the maximum daily rate at which hive bees are produced is  $L$  bees per day. However, this rate responds to colony size (smaller colonies have a lower capacity to produce hive bees) and the sensitivity of this size dependence is governed by tuning  $w$ . Similarly,  $\alpha$  and  $\sigma$  govern the rates of developmental transitions between hive bees and foragers, and  $m$  governs the daily per capita mortality rate.

In their analysis, Khoury et al. assumed that the rate of background mortality among foragers (i.e. deaths not due to pesticide exposure) was 15.4%, while hive bees did not suffer any mortality. The analysis below examines the impact on colony size of pesticide exposures that elevate the mortality rate by various multiples.



**Figure A2:** Behaviour of the model of a honey bee colony proposed by Khoury et al. (2011) with parameter values set as follows:  $N_0 = 22784$ ,  $L = 2000$ ,  $\alpha = 0.25$ ,  $\sigma = 0.75$ ,  $w = 27000$  and  $m$  set at various multiples of the background rate (Khoury et al., 2011). The y-axis shows the number of adult bees in the colony. In these calculations, the initial number of adult bees is set to equilibrate given background mortality among foragers (see trajectory labelled ‘ $x1m = 0.154$ ’). Other curves show trajectories when elevated rates of mortality due to pesticide exposure are applied continuously (e.g. when an additional 15.4% of foragers are killed daily by pesticide mortality, then the mortality rate is 30.8% (see trajectory labelled ‘ $x2m = 0.308$ ’).

**Table A1:** Extracts from Figure A2: number of days until effect (negligible, small, medium) under various levels of elevated forager mortality due to pesticide exposure ( $\times 1.5$  background,  $\times 2$ ,  $\times 3$ ) as determined by solutions to the model of Khoury et al. (2011). Colony viability is determined here by whether the colony contains at least 5000 adult bees after 50 days (5000 is often considered to be the minimum size suitable for successful overwintering)

Multiple of background mortality	Negligible (reduction in colony size of $\leq 7\%$ )	Small (reduction in colony size of $\leq 15\%$ )	Medium (reduction in colony size of $\leq 35\%$ )	Viable after 50 days?
$\times 1.5$ ( $m = 0.231$ )	6	13	40	Y
$\times 2$ ( $m = 0.308$ )	3	7	18	Y
$\times 3$ ( $m = 0.462$ )	2	4	10	N

## Appendix B. PROTECTION GOALS

Specific protection goals (SPGs) based on ecosystem services were suggested according to the methodology outlined in the scientific opinion of EFSA Panel on Plant Protection Products and their Residues (PPR) (2010). In consultation with risk managers in the SCoFCAH (Standing Committee on the Food Chain and Animal Health), the SPGs for honey bees were set as outlined below.

The attributes to protect were defined as survival and development of colonies and effects on larvae and bee behaviour as listed in regulation (EC) No 1107/2009. In addition, abundance/biomass and reproduction were also suggested because of their importance for the development and long-term survival of colonies.

The viability of each colony, the pollination services it provides, and its yield of hive products all depend on the colony's strength and, in particular, on the number of individuals it contains. It is therefore proposed to relate protection goals specifically to colony strength, which is defined operationally as the number of bees it contains (= colony size).

Based on expert judgement, the following nomenclature was defined for the magnitudes of detrimental impacts on colony, or 'effect sizes'.

Effect	Magnitude (reduction in colony size)
Large	> 35 %
Medium	15 % to 35 %
Small	7 % to 15 %
Negligible	3.5 % to 7 %

The variability in sizes among colonies prohibited defining effect sizes in terms of absolute reductions in the numbers of bees in a colony. Experts in the working group unanimously agreed that a proportional reduction in colony size of greater than one-third would be likely to compromise the viability, pollinating capability and yield of any colony; this consideration was used to define an effect as 'large'. The magnitude of a negligible effect was defined with similar regard to biological considerations and also by reference to the potential for experimental detection, because a negligible effect must be statistically distinguishable from "small effects". The intermediate effect sizes were then defined arbitrarily at even intervals in the range between 'large' and 'negligible'.

The effect sizes defined above have been defined principally by reference to honey bee colonies, but in the case of non-*Apis* bees, they will refer similar to colony-level impacts (other social bees, such as bumble bees) or to population sizes (solitary bees).

**Table B1:** Overview on combinations of magnitude of effects on forager mortality and time to reach point of where the colony may collapse (< 5000 bees in the hive) (for details see [Appendix A.](#))

Multiple of background mortality of forager bees	Negligible (reduction in colony size of ≤ 7 %)	Small (reduction in colony size of ≤ 15 %)	Medium (reduction in colony size of ≤ 35 %)	Viable after 50 days?
×1.5 ( $m = 0.231$ )	6 days	13 days	40 days	Y
×2 ( $m = 0.308$ )	3 days	7 days	18 days	Y
×3 ( $m = 0.462$ )	2 days	4 days	10 days	N

It was agreed in the SCoFCAH to base the specific protection goal on a negligible effect on colonies. For example, an increase in forager mortality by a factor of 1.5 compared with controls could be tolerated for six days (average factor over six days). From day 7 on, the mortality rate would need to be back to control. An increase of a factor of 2 could be tolerated for three days and an increase in mortality by a factor of 3 for two days. After that period of time the mortality of foragers should not exceed background mortality. The effect

on the colony should not exceed 7% compared with controls after two brood cycles. In the risk assessment (e.g. field studies) it needs to be ensured that the effects that are proposed for the SPGs can be assessed. For example, it needs to be ensured by the test design to detect an increase in mortality of more than a factor of 1.5 compared with controls with sufficient statistical power.

It is important to note that effects on colony should not exceed negligible effects also for products that are applied several times (according to the GAP). Risk management options should be considered if the magnitude of effects exceeds 'negligible' effects.

The overall level of protection also includes the exposure assessment goals. Decisions need to be taken on how conservative the exposure estimate should be and what percentage of exposure situations should be covered in the risk assessment. The first aspect of the spatial statistical population is the total area to be considered (e.g. the whole EU, one of the regulatory zones (north–centre–south) or a MS). In view of the terms of reference, we propose to consider each of the regulatory zones (north–centre–south) as the total area for all SPGs. A second aspect of the spatial statistical population is the location of the spatial units (individual bees, colonies or populations) in the landscape in relation to the application of the substance. It is proposed that the risk assessment focuses at field scale to avoid 'dilution' of the spatial population with a large fraction of unexposed hives, for example.

It was decided that the exposure assessment should be done for each of the regulatory zones and it was suggested that representative scenarios should be developed in future

By defining a certain percentile exposure assessment goal (e.g. 90%) it is meant that 90% of all colonies at the edge of a treated field in one regulatory zone should be exposed to less than what is assessed in the risk assessment. For 10% of the colonies at the edge of a field in the regulatory zone the exposure could exceed what was assessed in the risk assessment. For these colonies the protection may not be achieved for substances which are highly toxic to bees (e.g. effects could exceed negligible effects). It was proposed to base the exposure estimates at the 90th percentile, as is done for other groups of non-target organisms. However, there was also the suggestion to have a more conservative exposure assessment goal, such as the 95th percentile. The main concern was to be sufficiently conservative to avoid bee kill incidents. No final decision was taken by the SCoFCAH. The current version of the Guidance Document is based on the 90th percentile. If risk managers decide to choose a higher percentile after the public consultation period then the corresponding exposure values need to be changed in the final version of the Guidance Document.

The risk assessment scheme and associated trigger values enable an assessment that, if met, would ensure that exposure does not exceed a value that could lead to effects which are more than negligible in 90% of sites (i.e. treated fields) where honey bee colonies are situated on the edge of treated fields. The trigger values are set that an individual colony can tolerate an impact on foragers of  $y\%$  effect over  $Z$  time or less. This will ensure that the protection goal related to in-field pollination services of crop plants is met.

It is unclear if honey production would be a more sensitive endpoint than effects on mortality or reduction of colony size. It may be more difficult to assess effects on honey production because there is a high variability depending on the site where the colony is located. Since only negligible effects on the colonies are acceptable, the colony should stay as productive as a non-exposed one.

## Appendix C. RELEVANCE OF DUST FOR TREATED SEEDS

Most of this table is taken from SANCO/10553/2012 rev. 0, 8 March 2012, Guidance Document on the authorisation of Plant Protection Products for seed treatment (Annex I to Appendix VI) (EC, 2012). The last column is added to show relevance for off-field exposure of honey bees. The table is mainly based on seed treatment and sowing practice in the Netherlands.

**Table C1:** Representative coating practice and conditions of use of coated seeds

Crop	Direct sowing or transplanting	If direct sowing outdoors, type of drill (a)	Seed treatment technology (b)	Conclusion on dust formation (and potential risk for non-target organisms)
arable crops				
cereals spring	- Direct sowing	mostly mechanical and pneumatic seed drill equipment, pneumatic with vacuum principle upcoming	seed treatment facilities (fixed or mobile) and on farm treatment basic seed treatment / basic coating	Relevant
cereals winter	- Direct sowing	mostly mechanical and pneumatic seed drill equipment, pneumatic with vacuum principle upcoming	seed treatment facilities (fixed or mobile) and on farm treatment basic seed treatment / basic coating stickers more recently introduced more widely	Relevant
maize, sweet corn, sorghum	Direct sowing	90% vacuum principle	Professional treatment basic seed treatment direct on the seed (active ingredient can be present on the outside surface of the seed)	Relevant
oilseed rape	Direct sowing	mechanical and pneumatic seed drill equipment, pneumatic with vacuum principle upcoming	Professional treatment basic seed treatment / basic coating finishing powder to ensure flowability of seeds	Relevant
sunflower	Direct sowing	both mechanical and pneumatic with and without vacuum technique are possible	Professional treatment basic seed treatment / basic coating finishing powder to ensure flowability of seeds	Relevant
beet (sugar and fodder)	Direct sowing	Pneumatic or mechanical precision drilling equipment	Professional treatment pelleting, with active ingredient not on the outside of the seed but closed in by an inert layer; new development: filmcoating on top of the pellet	not relevant, due to pelleting and filmcoating (and mechanical drilling)
beans, peas	Direct sowing	Pneumatic (mainly vacuum technique) or mechanical precision drilling equipment	Professional treatment basic seed treatment / basic coating	Relevant
cotton	Direct sowing	Vacuum pneumatic drilling equipment	Professional treatment basic seed treatment / basic coating delinting process	Relevant

Crop	Direct sowing or transplanting	If direct sowing outdoors, type of drill (a)	Seed treatment technology (b)	Conclusion on dust formation (and potential risk for non-target organisms)
flax, poppy seed	Direct sowing	mostly mechanical seed drill equipment, pneumatic with vacuum principle upcoming	basic seed treatment / basic coating	Relevant
grasses, grasseed	Direct sowing	both mechanical and pneumatic (vacuum) are possible	basic seed treatment / basic coating	Relevant
alfalfa, caraway, green manure crops	Direct sowing	both mechanical and pneumatic (vacuum) are possible	no seed treatments	Not relevant (no seed treatments)
outdoor vegetables				
onion, carrot, radish	Direct sowing	Pneumatic precision drilling equipment	filmcoating/rotostat for insecticides	Not relevant for insecticides due to high quality coating; maybe relevant for other pesticides
leek	Most sowing in seed beds and transplanting later, approximately 10% direct sowing. Mostly sowing outdoors, some sowing indoors in trays.	Pneumatic precision drilling equipment	filmcoating/rotostat for insecticides	Not relevant for insecticides due to high quality coating; maybe relevant for other pesticides
asparagus	Sowing in seed beds, later transplanted.	yes	filmcoating/rotostat for insecticides	Not relevant for insecticides due to high quality coating; maybe relevant for other pesticides
chicory, endive, lamb's lettuce	Direct sowing	mainly coated seed, pneumatic ; also pelleted seeds, sown mechanically	filmcoating/rotostat for insecticides	Not relevant for insecticides due to high quality coating; maybe relevant for other pesticides
spinach	Direct sowing	mainly mechanically drilled, pneumatic equipment upcoming (both vacuum and gauge pressure principle)	basic coating, partly filmcoating, and sometimes toplayer	Relevant
beetroot	Direct sowing	Pneumatic precision drilling equipment	basic coating	Relevant
greenhouse vegetables				

Crop	Direct sowing or transplanting	If direct sowing outdoors, type of drill (a)	Seed treatment technology (b)	Conclusion on dust formation (and potential risk for non-target organisms)
lettuce, including lettuce-like (radichio rosso, endive, etcetera)	All these crops are only sown and raised to young plants indoors; later transplanted indoors or outdoors.	not applicable	pelleting, with active ingredient not on the outside of the seed but closed in by an inert layer	Not relevant due to indoor sowing
brassica, including head cabbages, Brussels sprouts, cauliflower, broccoli, Chinese cabbage, kale	All these crops are only sown and raised to young plants indoors; later transplanted indoors or outdoors.	not applicable	filmcoating/rotostat, and sometimes top layer	Not relevant due to indoor sowing
fruiting vegetables (tomatoes, cucumber, weet pepper, eggplant, etcetera)	Plant raising only indoors, later transplanted indoors or outdoors. In case of outdoor sowing (e.g. cucumber in Germany) vacuum systems are used.	Pneumatic precision drilling equipment	sometimes fungicide treatments	Not relevant due to indoor sowing
celeriac	Sown indoors, later transplanted outdoors.	not applicable		Not relevant due to indoor sowing
ornamentals				
several ornamental crops from seed	Cultivation both indoors and outdoors; many crops through plant raising indoors; limited crops directly sown outdoors.		filmcoating (high value seeds)	Not relevant for most crops due to indoor sowing; Relevant for some

(a) Mechanical seed drill equipment does not work with air and therefore can not release air flows. With pneumatic seed drill equipment there are two principles: using the vacuum principle and using the gauge pressure principle. When using the gauge pressure principle there is no more air replacement (with potential dust) than with mechanical seed drill equipment. When using the vacuum principle seeds are put in the sowing row by vacuum and the excess air will come free. At conventional corn sowing

machines, this exhaust air was directed upwards. Meanwhile, these machines (mostly) are modified: they have deflectors directing the exhaust air downwards to the soil.

- (b) There is no complete one-on-one relationship crop–seed treatment: which method is used also depends on, for example, the type of pesticide used, the composition of that pesticide and whether multiple pesticides are used, seed type (smooth, rough, etc.) and, to a certain extent, for which market the seed is treated, etc. Also, various terms are used. This table presents an indication. In general, the more valuable the seed is, the higher quality (and more expensive) seed treatment technology can be used. Furthermore, coating means that stickers are used; in basic coating the pesticide can irregularly be distributed over the seed; in film coating a regular layer is spread over the seed (used for somewhat higher valuable seeds); a part of the market has on top of that a top layer (without active ingredient).

In general, doses are lower for fungicide treatments than for insecticide treatments, which means that less coating is needed for fungicide treatments, so there is less coating available for abrasion. On the other hand, a top layer is then not necessary.

## **Appendix D. ATTRACTIVENESS OF AGRICULTURAL CROPS TO HONEY BEES AND BUMBLE BEES FOR THE COLLECTION OF NECTAR AND/OR POLLEN**

The establishment of a complete list of bee plants is difficult because most of the available literature (Ricciardelli d'Albore and Intoppa, 2000); (Contessi, 2005) dealing with bee flora does not try to be exhaustive on the plants that are visited by bees, but to be exhaustive on the plants which provide substantial resources in terms of nectar and pollen for beekeepers. Other data (Free, 1970; McGregor, 1976) focus only on the crops dependent upon or benefited by bee pollination. Moreover, honey bees are generalist and opportunistic pollinators. This means that even lowly attractive crops may be abundantly visited by bees in certain circumstances (e.g. a few varieties of flowering crops available in some area and/or in some period of the year). In this appendix we propose a list of crops visited by bees that is as complete as possible based on the data available in the literature (Free, 1970);(McGregor, 1976);(Ricciardelli d'Albore and Intoppa, 2000);(Contessi, 2005);(Klein et al., 2007); FloraApis website;(Ctgb, 2011).

The list contains an overview of the most agricultural crops in the EU (FAOSTAT (Food and Agriculture Organization), 2010) and it is indicated for each crop whether it is potentially visited by honey bees for the collection of nectar and/or pollen. The table also indicates if the crop is attractive to bumble bees and solitary bees and the presence of extrafloral nectaries.

Within a crop there may be differences depending on the agricultural practice. In general, all crops harvested before the flowering are not attractive to bees, except plants where extrafloral nectaries are present. Some crops (e.g. cauliflower, carrots, chicory) which usually do not flower during normal production, are indicated as attractive to bees because, in some cases, they can be cultivated for seed production. In other case, among the crops harvested before the flowering, some individual plants may flower. These flowering plants need to be removed in case that these flowers are attractive to bees. Otherwise a risk assessment is required.

The cultivation category of the ornamentals contains a large variety of crops. For this category it is assumed that non-flowering species are not attractive to bees while flowering species are attractive to bees.

A number of crops, including prunus, elder, willow, pumpkin, hollyhock, peony and sunflower, and a number of beans, including broad bean (*Vicia*), produce nectar from extrafloral nectarines (nectar glands outside the flower). A number of flowering plants (e.g. cornflower, sunflower), produce extrafloral nectar on the flower bud, even before the plants flowers. Exposure to products harmful to bees should be avoided in these cases. A list of plants with extrafloral nectaries can be found in Keeler (2008).

Due to the opportunistic behaviour of bees, a standard assessment (considering both pollen and nectar) has to be done in the screening and in the 1st tier, except in specific cases as indicated (see footnotes to the table D1).

**Table D1:** List of the main agricultural crops in Europe potentially visited by honey bees for pollen and/or for nectar. In bumblebees and solitary bees, when it is not specifically indicated, the crop can be visited both for pollen and nectar.

Crops	Definition	Honey bees		Bumble bees	Solitary bees	Extrafloral nectaries
		Pollen	Nectar			
Alfalfa	<i>Medicago sativa</i> . A deep-rooted perennial herb used for green fodder, for hay or silage, and for pasture.	+ (1)	+	+	+	
Almonds	<i>Prunus amygdalus</i> ; <i>P. communis</i> ; <i>Amygdalus communis</i> . Produced mainly in Mediterranean countries, the United States and Asia	+	+	+	+	
Anise, badian, fennel, corian (*)	Include: anise ( <i>Pimpinella anisum</i> ); badian or star anise ( <i>Illicium verum</i> ); caraway ( <i>Carum carvi</i> ); coriander ( <i>Coriandrum sativum</i> ); cumin ( <i>Cuminum cyminum</i> ); fennel ( <i>Foeniculum vulgare</i> ); juniper berries ( <i>Juniperus communis</i> ).	+	+	+ (2)	+	
Apples	<i>Malus pumila</i> ; <i>M. sylvestris</i> ; <i>M. communis</i> ; <i>Pyrus malus</i>	+	+	+	+	
Apricots	<i>Prunus armeniaca</i>	+	+	+	+	+
Artichokes (*)	<i>Cynara scolymus</i>	+	+	+ (2)	+	
Asparagus	<i>Asparagus officinalis</i>	+	+	+ (2)	+	
Avocados	<i>Persea americana</i>	+	+	+ (2)	+	
Bananas	<i>Musa sapientum</i> ; <i>M. cavendishii</i> ; <i>M. nana</i> .	+ (1)	+	+ (2)	+ (2)	

Crops	Definition	Honey bees		Bumble bees	Solitary bees	Extrafloral nectaries
		Pollen	Nectar			
Barley	<i>Hordeum</i> spp.: two-row barley ( <i>H. disticum</i> ) six-row barley ( <i>H. hexastichum</i> ) four-row barley ( <i>H. vulgare</i> ). Tolerates poorer soils and lower temperatures better than does wheat. Varieties include with husk and without (naked).	+ (1)	N/R	+ (3)	+ (3)	
Beans	<i>Phaseolus</i> spp.	+	+	+	+	+
Blueberries	European blueberry, wild bilberry, whortleberry ( <i>Vaccinium myrtillus</i> ); American blueberry ( <i>V. corymbosum</i> ). Trade data may include cranberries, myrtle berries and other fruits of the genus <i>Vaccinium</i>	+	+	+	+	
Broad beans, horse beans, dry	<i>Vicia faba</i> : horse-bean (var. <i>equina</i> ); broad bean (var. <i>major</i> ); field bean (var. <i>minor</i> )	+	+	+	+	+
Buckwheat	<i>Fagopyrum esculentum</i> (Polygonaceae). A minor cereal cultivated primarily in northern regions. Buckwheat is considered a cereal, although it does not belong to the gramineous family	+	+	+ (2)	+	

Crops	Definition	Honey bees		Bumble bees	Solitary bees	Extrafloral nectaries
		Pollen	Nectar			
Cabbages and other brassicas (*)	Chinese, mustard cabbage, pak-choi ( <i>Brassica chinensis</i> ); white, red, Savoy cabbage, Brussels sprouts, collards, kale and kohlrabi ( <i>Brassica oleracea</i> all varieties except <i>botrytis</i> )	+	+	+	+	
Carobs	<i>Ceratonia siliqua</i> Carob tree, locust bean. Includes also seeds. Mainly used as an animal feed and for industrial purposes. Rich in pectin	+	+	+(2)	+(2)	
Carrots (*)	<i>Daucus carota</i>	+	+	+	+	
Castor oil seed	<i>Ricinus communis</i> . Valued mainly for their oil, which is used in pharmaceutical products. Ground seedcakes are used as fertilisers (castor oil pomace)	+	+(1)	+(2)	+(2)	+
Cauliflowers and broccoli (*)	<i>Brassica oleracea</i> var. <i>botrytis</i> , subvarieties <i>cauliflora</i> and <i>cymosa</i> . Includes headed broccoli	+	+	+	+	
Cherries	Mazzard, sweet cherry ( <i>Prunus avium</i> ; <i>Cerasus avium</i> ); hard-fleshed cherry (var. <i>duracina</i> ); heart cherry (var. <i>juliana</i> )	+	+	+	+	+
Chestnuts	<i>Castanea</i> spp.: <i>C. vesca</i> ; <i>C. vulgaris</i> ; <i>C. sativa</i> . Produced mainly in Europe and Asia	+	+	+	+	
Chick peas	Chickpea, Bengal gram, garbanzos ( <i>Cicer arietinum</i> )	+	+	+	+	

Crops	Definition	Honey bees		Bumble bees	Solitary bees	Extrafloral nectaries
		Pollen	Nectar			
Chicory roots (*)	<i>Cichorium intybus</i> subsp. <i>sativum</i> . Unroasted chicory roots	+	+	+	+	
Chillies and peppers	Red and cayenne pepper, paprika, chillies ( <i>Capsicum frutescens</i> ; <i>Capsicum annuum</i> ); allspice, Jamaica pepper ( <i>Pimenta officinalis</i> )	+	+	+	+	
Clover for forage and silage	<i>Trifolium</i> spp. Various species grown for pasture, green fodder or silage	+	+	+	+	
Coffee, green	<i>Coffea</i> spp. ( <i>arabica</i> , <i>robusta</i> , <i>liberica</i> ). Raw coffee in all forms	+	+	+(2)	+	
Cow peas	Cowpea, blackeye pea/bean ( <i>Vigna unguiculata</i> )	+(1)	+	+	+(2)	+
Cranberries	American cranberry ( <i>Vaccinium macrocarpon</i> ); European cranberry ( <i>V. oxycoccus</i> ). Trade data may include blueberries, myrtle berries and other fruits of the genus <i>Vaccinium</i>	+	+	+	+	
Cucumbers and gherkins	<i>Cucumis sativus</i>	+	+	+	+	
Currants	Black ( <i>Ribes nigrum</i> ); red and white ( <i>R. rubrum</i> ). Trade data may sometimes include gooseberries	+(1)	+	+	+	
Dates	<i>Phoenix dactylifera</i> . Includes fresh and dried fruit	+	N/R	+(3)	+(3)	
Eggplants (aubergines)	<i>Solanum melongena</i> . Also called aubergines	+(1)	N/R	+(3)	+(3)	

Crops	Definition	Honey bees		Bumble bees	Solitary bees	Extrafloral nectaries
		Pollen	Nectar			
Elder	<i>Sambucus nigra</i>	+	+	+ (2)	+	+
Figs	<i>Ficus carica</i>	N/R	N/R	N/R	N/R	
Garlic (*)	<i>Allium sativum</i>	+	+	+ (2)	+	
Gooseberries	<i>Ribes grossularia</i> . Trade data may sometimes include black, white or red currants	+ (1)	+	+	+	
Grapefruit (inc. pomelos)	<i>Citrus maxima</i> ; <i>C. grandis</i> ; <i>C. paradisi</i>	+	+	+	+	
Grapes	<i>Vitis vinifera</i> . Includes both table and wine grapes	+	+ (1)	+ (2)	+	
Grasses Nes for forage; Silage	Including <i>inter alia</i> : bent, redtop, fiorin grass ( <i>Agrostis</i> spp.); bluegrass ( <i>Poa</i> spp.); Columbus grass ( <i>Sorghum alnum</i> ); fescue ( <i>Festuca</i> spp.); Napier, elephant grass ( <i>Pennisetum purpureum</i> ); orchard grass ( <i>Dactylis glomerata</i> ); Rhodes grass ( <i>Chloris gayana</i> )	+ (4)	+ (4)	+ (4)	+ (4)	
Groundnuts, with shell	<i>Arachis hypogaea</i> . For trade data, groundnuts in shell are converted at 70 % and reported on a shelled basis	+	N/R	+ (3)	+ (3)	
Hazelnuts, with shell	<i>Corylus avellana</i> . Produced mainly in Mediterranean countries and the United States	+	N/R	+ (3)	+ (3)	
Hemp	<i>Cannabis sativa</i> . This plant is cultivated for seed as well as for fibre	+	+ (1)	+ (2)	+ (2)	+

Crops	Definition	Honey bees		Bumble bees	Solitary bees	Extrafloral nectaries
		Pollen	Nectar			
Hops	<i>Humulus lupulus</i> . Hop cones, fresh or dried, whether or not ground, powdered or in the form of pellets. Includes lupuline, a yellow resinous powder that covers the hop cones. Mainly used in the brewing industry to give flavour to beer	+ (1)	N/R	+ (3)	+ (3)	
Kiwi fruit	<i>Actinidia chinensis</i>	+	N/R	+ (3)	+ (3)	
Leeks, other alliaceous vegetables (*)	Leeks ( <i>Allium porrum</i> ); chives ( <i>A. schoenoprasum</i> ); other alliac	+	+	+ (2)	+	
Leguminous for silage	Including <i>inter alia</i> : birdsfoot, trefoil ( <i>Lotus corniculatus</i> ); lespedeza ( <i>Lepedeza</i> spp.); kudzu ( <i>Pueraria lobata</i> ); sesbania ( <i>Sesbania</i> spp.); sainfoin, esparcette ( <i>Onobrychis sativa</i> ); sulla ( <i>Hedysarum coronarium</i> ).	+	+	+	+	
Leguminous vegetables, Nes	<i>Vicia faba</i> . For shelling	+	+	+	+	+
Lemons and limes	Lemon ( <i>Citrus limon</i> ); sour lime ( <i>C. aurantifolia</i> ); sweet lime ( <i>C. limetta</i> )	+	+	+	+	
Lentis	<i>Lens esculenta</i> ; <i>Ervum lens</i>	+	+	+ (2)	+ (2)	+
Lettuce (*)	<i>Lactuca sativa</i>	+ (2)	N/R	+ (3)	+ (3)	
Linseed	<i>Linum usitatissimum</i> Flaxseed. An annual herbaceous that is cultivated for its fibre as well as its oil	+	+	+	+ (2)	

Crops	Definition	Honey bees		Bumble bees	Solitary bees	Extrafloral nectaries
		Pollen	Nectar			
Lupins	<i>Lupinus</i> spp. Used primarily for feed, though in some parts of Africa and in Latin America some varieties are cultivated for human food	+	+	+	+	
Maize	<i>Zea mays</i> corn, Indian corn, mealies. A grain with a high germ content. At the national level, hybrid and ordinary maize should be reported separately owing to widely different yields and uses. Used largely for animal feed and commercial starch production	+	N/R	+ (3)	+ (3)	
Melon	<i>Cucumis melo</i>	+ (1)	+	+	+	
Mushrooms and truffles	Including <i>inter alia</i> : <i>Boletus edulis</i> ; <i>Agaricus campestris</i> ; <i>Morchella</i> spp. and <i>Tuber magnatum</i> . Cultivated or spontaneous. Includes truffles	Not applicable				
Mustard seed	White mustard ( <i>Brassica alba</i> ; <i>B. hirta</i> ; <i>Sinapis alba</i> ); black mustard ( <i>Brassica nigra</i> ; <i>Sinapis nigra</i> ). In addition to the oil extracted from them, white mustard seeds, may be processed into flour for food use.	+	+	+	+	

Crops	Definition	Honey bees		Bumble bees	Solitary bees	Extrafloral nectaries
		Pollen	Nectar			
Oats	<i>Avena</i> spp., mainly <i>Avena sativa</i> . A plant with open, spreading panicle-bearing large spikelets. Used primarily in breakfast foods. Makes excellent fodder for horses	+ (1)	N/R	+ (3)	+ (3)	
Okra	<i>Abelmoschus esculentus</i> ; <i>Hibiscus esculentus</i> . Also called gombo	+	+	+	+	+
Olives	<i>Olea europaea</i> . Includes table olives and olives for oil	+	N/R	+ (3)	+ (3)	
Onions (*)	<i>Allium cepa</i>	+	+	+ (2)	+	
Oranges	Common, sweet orange ( <i>Citrus sinensis</i> ); bitter orange ( <i>C. aurantium</i> ). Bitter oranges are used primarily in the preparation of marmalade	+	+	+	+	
Peaches and nectarines	<i>Prunus persica</i> ; <i>Amygdalus persica</i> ; <i>Persica laevis</i>	+	+	+	+	+
Pears	<i>Pyrus communis</i>	+	+	+	+	
Peas	Garden pea ( <i>Pisum sativum</i> ); field pea ( <i>P. arvense</i> )	+	+	+	+	
Peppermint	<i>Mentha</i> spp.: <i>M. piperita</i> . Leaves and flowers are used in the perfumery, food and other industries	+	+	+ (2)	+	
Persimmons	<i>Diospyros kaki</i> ; <i>D. virginiana</i> .	+	+	+	+	

Crops	Definition	Honey bees		Bumble bees	Solitary bees	Extrafloral nectaries
		Pollen	Nectar			
Pistachios	<i>Pistacia vera</i> . Produced mainly in the Near East and the United States	+	N/R	+ (3)	+ (3)	
Plums and sloes	Greengage, mirabelle, damson ( <i>Prunus domestica</i> ); sloe ( <i>P. spinosa</i> )	+	+	+	+	
Poppy seed	<i>Papaver somniferum</i> . The source of opium, poppy seeds are also used in baking and confectionery	+	N/R	+ (3)	+ (3)	
Potatoes	<i>Solanum tuberosum</i> Irish potato. A seasonal crop grown in temperate zones all over the world, but primarily in the northern hemisphere	+ (1)	N/R	+ (3)	+ (3)	
Pumpkins, squash and gourds	<i>Cucurbita</i> spp. Includes marrows	+ (1)	+	+ (2)	+	
Pyrethrum, dried	<i>Chrysanthemum cinerariifolium</i> . Includes leaves, stems and flowers. For insecticides, fungicides and similar products.	+	+ (1)	+ (2)	+ (2)	
Quinces	<i>Cydonia oblonga</i> ; <i>C. vulgaris</i> ; <i>C. japonica</i>	+	+	+ (2)	+ (2)	
Rapeseed	<i>Brassica napus</i> var. <i>oleifera</i> . Valued mainly for its oil. Older varieties are rich in erucic acid, which is considered unhealthy	+	+	+	+	

Crops	Definition	Honey bees		Bumble bees	Solitary bees	Extrafloral nectaries
		Pollen	Nectar			
Raspberries (and similar berries)	<i>Rubus idaeus</i> . Trade data may include blackberries, mulberries and loganberries (a cross between the raspberry and blackberry)	+	+	+	+	
Rice, paddy	<i>Oryza</i> spp., mainly <i>Oryza sativa</i> . Rice grain after threshing and winnowing. Also known as rice in the husk and rough rice. Used mainly for human food	+ (1)	N/R	+ (3)	+ (3)	
Rye	<i>Secale cereale</i> . A grain that is tolerant of poor soils, high latitudes and altitudes. Mainly used in making bread, whisky and beer. When fed to livestock, it is generally mixed with other grains	+ (1)	N/R	+ (3)	+ (3)	
Rye grass for forage and silage	Italian ryegrass ( <i>Lolium multiflorum</i> ); English, perennial ryegrass ( <i>L. perenne</i> ). Quick-growing grasses	+ (1)	N/R	+ (3)	+ (3)	
Safflower seed	<i>Carthamus tinctorius</i> . Valued mainly for its oil. Minor uses include as a human food and as poultry feed	+	+	+ (2)	+	
Seed cotton	<i>Gossypium</i> spp.: Unginned cotton. Grown for both seed and for fibre	+ (1)	+	+	+	+
Serradella/birdsfoot	<i>Ornithopus sativus</i>	+	+	+ (2)	+ (2)	

Crops	Definition	Honey bees		Bumble bees	Solitary bees	Extrafloral nectaries
		Pollen	Nectar			
Sesame seed	<i>Sesamum indicum</i> . Valued for its oil, but also as a food, either raw or roasted, as well as in bakery products and other food preparations.	+	+	+ (2)	+	+
Sorghum	<i>Sorghum</i> spp.: guinea corn ( <i>S. guineense</i> ); common, milo, feterita, kaffir corn ( <i>S. vulgare</i> ); durra, jowar, kaoliang ( <i>S. dura</i> ). A cereal that has both food and feed uses. Sorghum is a major food grain in most of Africa, where it is also used in traditional	+ (1)	N/R	+ (3)	+ (3)	
Soybeans	<i>Glycine soja</i> . The most important oil crop. Also widely consumed as a bean and in the form of various derived products because of its high protein content, e.g. soya milk, meat, etc.	+	+	+	+	
Spices, Nes	Including <i>inter alia</i> : bay leaves ( <i>Laurus nobilis</i> ); dill seed ( <i>Anethum graveolens</i> ); fenugreek seed ( <i>Trigonella foenum-graecum</i> ); saffron ( <i>Crocus sativus</i> ); thyme ( <i>Thymus vulgaris</i> ); turmeric ( <i>Curcuma longa</i> )	+	+	+ (2)	+	
Spinach (*)	<i>Spinacia oleracea</i> . Trade figures may include New Zealand spinach ( <i>Tetragonia expansa</i> ) and orache (garden) spinach ( <i>Atriplex hortensis</i> )	+ (1)	+ (1)	+ (2)	+ (2)	

Crops	Definition	Honey bees		Bumble bees	Solitary bees	Extrafloral nectaries
		Pollen	Nectar			
Strawberries	<i>Fragaria</i> spp.	+	+	+	+	
Sugar beet	<i>Beta vulgaris</i> var. <i>altissima</i> . In some producing countries, marginal quantities are consumed, either directly as food or in the preparation of jams	+ (1)	+	+ (2)	+	
Sugar cane	<i>Saccharum officinarum</i> . In some producing countries, marginal quantities of sugar cane are consumed, either directly as food or in the form of juice	+ (1)	N/R	+ (3)	+ (3)	
Sunflower seed	<i>Helianthus annuus</i> . Valued mainly for its oil. Minor uses include as a human food and as feed for birds	+	+	+	+	+
Sweet potatoes	<i>Ipomoea batatas</i> . A seasonal crop grown in tropical and subtropical regions. Used mainly for human food. Trade data cover fresh and dried tubers, whether or not sliced or in the form or pellets	+ (2)	+ (2)	+ (2)	+ (2)	
Tangerines, mandarins, clementines	Mandarin, tangerine ( <i>Citrus reticulata</i> ); clementine, satsuma ( <i>C. unshiu</i> )	+	+	+	+	

Crops	Definition	Honey bees		Bumble bees	Solitary bees	Extrafloral nectaries
		Pollen	Nectar			
Tobacco, unmanufactured (*)	<i>Nicotiana tabacum</i> . Unmanufactured dry tobacco, including refuse that is not stemmed or stripped, or is partly or wholly stemmed or stripped	+	N/R	+ (3)	+ (3)	
Tomatoes	<i>Lycopersicon esculentum</i>	+ (1)	N/R	+ (3)	+ (3)	
Triticale	A minor cereal that is a cross between wheat and rye, combining the quality and yield of wheat with the hardness of rye	+ (1)	N/R	+ (3)	+ (3)	
Turnips for Fodder (*)	<i>Brassica rapa</i> var. <i>rapifera</i> . Especially cultivated for fodder	+	+	+	+	
Vetches	Spring/common vetch ( <i>Vicia sativa</i> ). Used mainly for animal feed	+	+	+	+	+
Viper's grass	<i>Scorzonera hispanica</i>	+	+	+ (2)	+	
Walnuts, with shell	<i>Jugland</i> spp.: <i>J. regia</i> . Produced in temperate zones of the northern hemisphere, particularly in the United States	+	+ (1)	+ (2)	+	
Watermelons	<i>Citrullus vulgaris</i>	+	+	+	+	

Crops	Definition	Honey bees		Bumble bees	Solitary bees	Extrafloral nectaries
		Pollen	Nectar			
Wheat	<i>Triticum</i> spp.: common ( <i>T. aestivum</i> ) durum ( <i>T. durum</i> ) spelt ( <i>T. spelta</i> ). Common and durum wheat are the main types. Among common wheat, the main varieties are spring and winter, hard and soft, and red and white.	+ (1)	N/R	+ (3)	+ (3)	

Symbols in the table: + crop visited by pollen and/or nectar collection;

**N/R**= no relevant because:

- 1.- crop not attractive for bees, or
- 2.- crop does not produced pollen or nectar, or
- 3.- nectaries and/or anthers are not accessible

\*= crops harvest usually before flowering

**empty cells**= not available information

Notes:

- In some cases (mainly cases indicated by footnotes) the table indicates attractiveness although it is likely that intensive foraging on the crop for pollen/nectar is rare (see also first page of this appendix). If it is considered that for a particular risk assessment no attractiveness of the crop should be taken into consideration, the case should be further argued and supported by data/information (e.g. crop harvested or cut before the flowering; complete cleistogamous species/variety are cultivated; male/female plants which can offer pollen/nectar are not cultivated).
- empty cell means no information was available (for extrafloral nectaries)

Footnotes:

- \* indicates that crops usually harvested before the flowering
- (1) Generally this crop is considered low attractive to bees for pollen/nectar but their collection cannot be excluded at all due to controversial information found in literature. Data to exclude the pollen/nectar collection by bees need to be provided
- (2) No information available. Data to exclude the pollen/nectar collection by bees need to be provided
- (3) This crop is not visited by bees for nectar but attractiveness for pollen cannot be excluded. Data to exclude pollen collection need to be provided
- (4) If grassland consists of species not specifically included in this table, the presence of attractive species for bees is assumed. If the grassland consist only the species included in the table and or maintained continuously cut down (before flowering), than the grassland is considered as not attractive to bees.

## Appendix E. LANDSCAPE-LEVEL EXPOSURE ASSESSMENT OF THE AVERAGE CONCENTRATION ENTERING THE HIVE

### Introduction

As described in [Section 5.1.5](#) the proposed risk assessment for consumption of nectar and pollen in the hive is based on the conservative approach assuming that bees forage exclusively on one type of plant. This conservative approach can in the longer term be replaced with a more realistic approach considering foraging on all attractive plants in the foraging area at the landscape level. The most straightforward path to this more realistic approach is to develop a model for the foraging behaviour and to test and calibrate this in field experiments. Therefore here a first approach for such a model is described as a starting point for further development of such models.

### Landscape-level exposure assessment model

Let us consider a foraging area of a hive that consists of  $N$  different fields. The average concentration in the hive ( $PEC_{hive}$ ) can then as a first approximation be estimated with

$$PEC_{hive} = \frac{\sum_{n=1}^N f_n a_n PEC_n}{\sum_{n=1}^N f_n a_n} \quad (E1)$$

where  $f_n$  is the attractiveness factor of the crop in field  $n$ ,  $a_n$  is the surface area of field  $n$  and  $PEC_n$  is the concentration in nectar and pollen in field  $n$ . The definition of  $f_n$  can be illustrated with the example of a foraging area consisting of two fields of equal size, one grown with *Phacelia* and one grown with pumpkin. Let us further assume that  $f_{Phacelia} = 10$  and  $f_{pumpkin} = 1$ . Eqn E1 reduces in this case into

$$PEC_{hive} = \frac{10PEC_{Phacelia} + PEC_{pumpkin}}{11} \quad (E2)$$

So the attractiveness factor is a quantitative measure of the attractiveness of different crops and can best be defined in relation to a reference crop (e.g. pumpkin, as was done in the example of Eqn E2). This factor can be measured by counting the number of foraging bees within a surface area of e.g.  $1\text{m}^2$  at the same time in different fields within the foraging area. Typical values are  $25/\text{m}^2$  for *Phacelia* and  $3/\text{m}^2$  for a flowering pumpkin crop (these numbers would then correspond to  $f_{Phacelia} = 8.333$  and  $f_{pumpkin} = 1$ , taking pumpkin as the reference crop; we use in the example 10 instead of 8.33 to keep the numbers simple).

Let us consider the most normal situation for the exposure assessment: use of a certain substance in a single crop in a foraging area. Let us further define  $\varphi$  as the fraction of the crop treated with this substance (e.g. because there are different products used for the same pest) and  $A_g$  as the total surface area grown with crop  $g$  (so the sum of all  $a_n$  values of the fields grown with the same crop  $g$ ). In such a case, Eqn E1 reduces to

$$PEC_{hive} = \frac{f_x A_x \varphi PEC_x}{\sum_{g=1}^G f_g A_g} \quad (E3)$$

where  $f_x$  is the attractiveness factor of the treated crop,  $A_x$  is the total surface area of crop  $x$  in the foraging area,  $PEC_x$  is the concentration in nectar or pollen in the treated crop,  $G$  is the total number of

attractive plants in the foraging area and  $f_g$  is the attractiveness factor of plant  $g$ . If there are attractive plants that are no crops (e.g. weeds in field margins), these can of course also be included in the sum in the denominator of Eqn E3.

Based on Eqn E3 we can define  $\Phi$  as the ‘foraging dilution factor’ for crop  $x$  and this hive as:

$$\Phi = \frac{PEC_x}{PEC_{hive}} = \frac{f_x A_x \varphi}{\sum_{g=1}^G f_g F_g} \quad (E4)$$

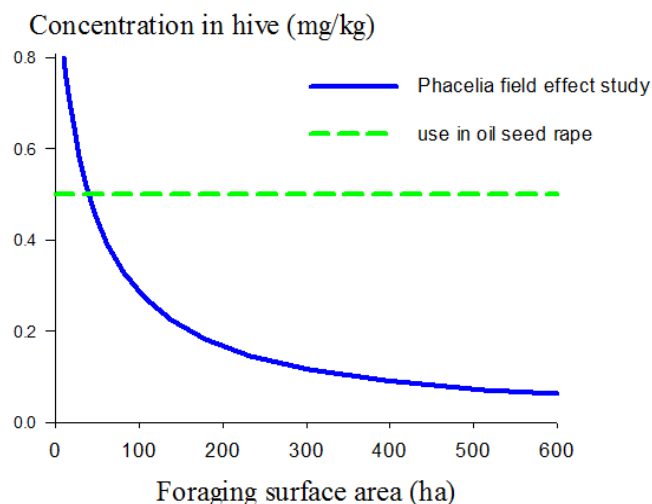
If  $\Phi$  is, for example, 0.3, this means that the average concentration in pollen or nectar entering the hive is 0.3 times the concentration in pollen or nectar from fields treated with this substance.

### Effect of the foraging surface area on the risk assessment

The foraging surface area of a hive is not exactly known, so it is useful to know which role this surface area may play in the risk assessment. Any risk assessment for organisms is based on two types of exposure assessment: one for the exposure in the effect study and one for the exposure that will occur in the field resulting from the use of the plant protection product (Boesten et al., 2007). Let us first consider the exposure in the field. Let us consider the use of a substance in oilseed rape applied at a rate of 1 kg/ha and the resulting concentration in the nectar entering the hives at the edges of treated field. Let us assume the following scenario: (1) 25% of the surface area in the landscape is grown with oilseed rape; (2) this substance is applied to half of the oilseed rape fields; (3) there are no other attractive plants in the landscape; (4) the concentration in the nectar of treated fields is 1mg/kg. Eqn E3 gives then a  $PEC_{hive}$  of 0.5 mg/kg because only 50% of the oilseed rape surface area is treated ( $\varphi = 0.5$ ). The size of the foraging surface area has no effect on the  $PEC_{hive}$  in this scenario because we assume that the land use does not change.

Let us now consider exposure in the higher tier field study. Let us consider therefore the following simplified example: the highest tier regulatory acceptable concentration for the hive ( $RAC_{hive}$ ) was based on a field study with a hive at the edge of a 1-hectare *Phacelia* field that was treated with the substance and in which no unacceptable effects were observed. If the concentration in nectar entering the hive was measured in the field study, we do not need any assumptions on the foraging surface area. So in this case such assumptions play no role in the risk assessment.

However, if this concentration was not measured (as is the case in many current dossiers), the  $RAC_{hive}$  has to be calculated from Eqn E1. Let us assume the same landscape scenario: 25% of surface area is grown with attractive oilseed rape plants (now untreated) 1-hectare of a *Phacelia* field treated at a rate of 1 kg/ha close to the hive. We assume that the concentration in the nectar of the *Phacelia* is again 1 mg/kg. Let us assume  $f_{Phacelia} = 10$  and  $f_{OSR} = 1$ . For a total foraging area of 10 ha, Eqn E1 gives then  $RAC_{hive} = 10/(10+2.5) = 0.80$  mg/kg. However, for a total foraging area of 100 ha, Eqn E1 gives  $RAC_{hive} = 10/(10+25) = 0.29$  mg/kg. Figure E1 illustrates this strong dependence of the  $RAC_{hive}$  of the foraging surface area. We consider a foraging radius of one kilometre to be a defensible minimum value for a hive. This corresponds to about 3 km<sup>2</sup>, so 300 ha. Figure E1 indicates that it is well possible that the exposure in such a *Phacelia* effect study is considerably lower than in a realistic field exposure scenario.



**Figure E1:** Concentration in the nectar entering the hive as a function of the foraging surface area as calculated with Eqn E1 for an application in oilseed rape and for an application in a *Phacelia* field effect study. It was assumed that the PEC in the treated *Phacelia* and oilseed rape fields was 1 mg/kg

Figure E1 shows that the  $RAC_{hive}$  decreases with increasing foraging surface area for field studies in which the concentrations in pollen and nectar have not been measured. The lower the  $RAC_{hive}$ , the more conservative the risk assessment will be. To be able to use such studies, consensus needs to be achieved on a realistic upper limit of a foraging surface area of a hive. Moreover, the surface area of attractive crops within this foraging surface area during the field effect study needs to be assessed. This will in general not be an easy task. It seems therefore advisable to measure the concentrations in nectar and pollen entering the hive in future field effect studies.

## Appendix F. PESTICIDE RESIDUE LEVELS IN NECTAR AND POLLEN AND THE RESIDUE UNIT DOSES (RUDS)

Three main sources of data to be considered in order to develop a dataset for RUD (residue unit dose) values were:

- Appendix G. of the EFSA Opinion (EFSA Panel on Plant Protection Products and their Residues (PPR), 2012a);
- Tables 1.5, 1.6 and 1.8 of the external scientific report (Thompson, 2012);
- The data in the excel sheet compiled for the EFSA statement (EFSA, 2012). Detailed data were not published in the statement; thus, references are provided for these data in Table H2 of this appendix.

Moreover, some additional data were included if they had been erroneously left out from one or the other database or EFSA was not aware of the existence of these data when the above documents had been finalised. Where necessary, further details of the relevant studies (where they were available to EFSA) or the original study reports were consulted for further information or corrections (e.g. several RUD values for thiamethoxam and its metabolite CGA322704 were reported in Table G11 of the opinion (EFSA Panel on Plant Protection Products and their Residues (PPR), 2012a), but not reported here since they were based on results of below the limit of detection (LOD)). In some cases, different RUD values from the same origin (from same study) were reported in two different datasets (e.g. one based on average of subsamples and the other on the highest value). For these cases, where reliable information was available, the worst-case (e.g. the highest measured) residue value was used for the RUD calculations. From a study, sometimes more than one value was derived and reported here when more than one trial was conducted within a study. A standalone trial was defined when one or more of the following factors were different from other trials: plant, test site, time of the trial, application rate, pre-treatment of the soil. When several measurements of residues for the same matrix were available within a trial, only the highest value was used for the RUD calculation. This applied also for the mode of sampling (i.e. samples from the plant, from the bee or from the comb, if available, were not considered separately). In some cases, the only differences between trials were the time of application with a few days' difference. In these cases, only the data from the trial with the worst-case value were considered further. It is noted that in some cases of spray application, residue data were available only some days after the application (i.e. it is not known whether residue levels were higher shortly after the treatment).

Two reported values were derived from greenhouse studies on sunflower. It was considered that the residues determined in this studies cannot be combined with the residues investigated in field or semi-field trials; therefore, these greenhouse data were not used in the data analysis and are not reported here (all other values originate from open field trials). Data for rape crop are not separated here to spring and winter oilseed rape. Where the residue detected in a trial was reported to be between the limit of quantification (LOQ) and the limit of detection (LOD), as a worst-case assumption, the residue was considered to be equal to the LOQ for the calculations. When the exact value measured between the LOD and the LOQ was reported than this reported value was used in the calculations.

In cases when toxic metabolites were also identified in nectar or pollen, the residue levels were summed with the residue level of the parent and the RUD values were derived from this combined value. It should be noted that, in these cases, the highest reported values were always used. Results from subsamples were not considered separately, which may mean that the combined residue originates from different subsamples (but from the same trial). Since metabolites were investigated for only a few parent molecules, this was only done in a limited number of cases: only for thiamethoxam, where metabolite CGA322704 (=clothianidin) was summed with parent thiamethoxam. This approach is considered as a worst-case approach, especially in cases where residue levels equal to the LOQ were considered in the calculations, while the actually measured levels were below the LOQ (as explained above). Olefine and the monohydroxy metabolites of imidacloprid were not detected in the available

studies and therefore are not considered here. Metabolites of clothianidin, TZMU (thiazolylmethylurea) and TZNG (thiazolylnitroguanidine), were also not considered in the RUD calculations, since these molecules are more than three order of magnitude less toxic to bees<sup>26</sup> than the parent clothianidin. Single values are available for the metabolite CGA322704 (=clothianidin) and for the metabolite RPA200766 (metabolite of fipronil). In these trials the parent compounds (thiamethoxam or fipronil) were not detected. Additionally, for spirotetramat some or all of the following metabolites were summed with the residue level of the parent: -enol, -keto-hydroxy, -mono-hydroxy, -enol-glucoside. Information on the toxicity of these metabolites to bees was not available.

It should be noted that the majority of the studies were not conducted under Good Laboratory Practice (GLP) rules.

The compiled RUD values derived from foliar spray applications are reported in Table F1, while the RUD values derived from seed dressing applications are reported in Table F2. All values in Table F1 refer to the theoretical application rate of 1 kg a.s./ha. Regarding seed dressing (Table F2), where suitable information was available, two sets of data were calculated. One is based on the seed loading and the values refer to the theoretical seed dressing rate of 1 mg a.s./seed, and the other set of data is based on application rate expressed in applied mass per area, i.e. 1 kg a.s./ha.

The cumulative distributions of the RUD values (with lognormal fits) from spray applications are visualised in Figures F1 and F2. Values originating from downwards and up/sideward spraying technology are separated.

As regards granular applications, only two RUD values could be derived for clothianidin in maize pollen from the studies by Dilger (2011) in the dossier submitted by the applicant. These values were 0.065 and 0.1 mg/kg for the theoretical application rate of 1 kg a.s./ha.

**Table F1:** RUD values referring to an application rate of 1 kg a.s./ha derived from foliar spray applications

Compound	Crop	RUD (mg/kg) pollen	RUD (mg/kg) nectar	Reference	Data source
Acephate methamidophos +	Raspberry	–	20.7	Fiedler, 1987	esr
Acephate methamidophos +	Cherry*	–	4.1	Fiedler, 1987	esr
Acephate methamidophos +	Apple*	–	11.3	Fiedler, 1987	esr
Acetamiprid	Rape	14.8	–	Rexer, 2010, S10–01355	
Acetamiprid	Rape	3.4	–	Rexer, 2010, S10–01355	
Azoxystrobin	Rape	–	5.8	Schatz, Wallner, 2009	op
Boscalid	Rape	–	1.0	Schatz, Wallner, 2009	op
Boscalid	Rape	–	6.4	Schatz, Wallner, 2009	op
Boscalid	Rape	52.4	2.9	Wallner, 2009	op/esr
Captan	Apple*	9.5	–	Kubik et al. 2000	esr
Carbaryl	Alfalfa	0.2	–	Stanger and Winterlin, 1975	esr
Carbendazim met.	–	–	1.3	Schatz, Wallner 2009	op
Carbofuran	Maize	0.0 <sup>(1)</sup>	–	Data from DAR	op
Carbofuran	Alfalfa	10.5	–	Moffett et al., 1986	esr
Carbofuran	Alfalfa	4.1	–	Moffett et al., 1986	esr
Chlorantranilprole	Phacelia	47.3	0.8	Szinicz, 2006	

<sup>26</sup> Based on the acute oral LD<sub>50</sub> values as reported in the DAR of clothianidin (Belgium, 2003).

Compound	Crop	RUD (mg/kg) pollen	RUD (mg/kg) nectar	Reference	Data source
Chlorantraniliprole	Phacelia	43.0	0.6	Dinter et al., 2009	esr
Cypermethrin	Rape	43.1	–	Fries and Wibran, 1987	esr
Difenoconazole	Apple*	0.8	–	Kubik et al., 2000	esr
Difenoconazole	Apple*	0.2	–	Skerl et al., 2009	esr
Dimethoate	Lemons*	–	1.4	Waller et al., 1984	esr
Dimoxystrobin	Rape	–	1.7	Schatz, Wallner 2009	op
Endosulfan	Mustard	4.2	3.5	Choudhary and Sharma, 2008	esr/op
Endosulfan	Mustard	4.1	3.1	Choudhary and Sharma, 2009	esr/op
Ethylparathion	Sunflower	3.4	–	Cox et al., 1986	esr
Flufenoxuron	Phacelia	18.3	–	Data from DAR	op
Flufenoxuron	Phacelia	90.5 <sup>(2)</sup>	2.0	Data from DAR	op
Flufenoxuron	Phacelia	8.0	–	Data from DAR	op
Flufenoxuron	Grape*	1.5	–	Data from DAR	op
Fluvalinate	Rape	–	12.5	Schatz, Wallner 2009	op
Fluvalinate	Apple*	1.8	–	Haouar et al., 1990	esr
Gamma-cyhalothrin	Rape	21.3	2.3	Barth et al., 111048020 B	op
Iprodione	Rape	–	5.7	Schatz, Wallner 2009	op
Iprodione	Cherry*	0.3 <sup>(3)</sup>	–	Kubik et al., 1999	esr
Lambda-cyhalothrin	Mustard	22.3	11.4	Choudhary and Sharma, 2008	esr/op
Lambda-cyhalothrin	Mustard	21.5	11.1	Choudhary and Sharma, 2009	esr/op
Metconazol	Rape	–	3.7	Schatz, Wallner 2009	op
Methyl-parathion	Alfalfa	2.0	–	Moffett et al., 1986	esr
Methyl-parathion	Alfalfa	2.1	–	Moffett et al., 1986	esr
Methyl-parathion	Alfalfa	11.8	–	Johansen and Kious, 1978	esr
Methyl-thiophanate	Cherry*	1.2	–	Kubik et al., 1999	esr
Monocrotofos	Alfalfa	0.5	–	Stanger and Winterlin, 1975	esr
PP321 (pyrethroid)	Rape	40.0	–	Fries and Wibran, 1988	esr
Procymidon	Strawberry	0.04	–	Kubik et al., 1992	esr
Prothioconazole	Rape	–	0.1	Schatz, Wallner	op
Prothioconazole	Rape	–	2.8	Wallner, 2009	op/esr
Spiromesifen	Mustard	9.3	6.5	Choudhary and Sharma, 2008	esr/op
Spiromesifen	Mustard	8.1	6.3	Choudhary and Sharma, 2009	esr/op
Spirotetramat metabolites +	Phacelia	63.5	3.3	Schnorbach et al., 2007	
Spirotetramat metabolites +	Rape	83.1	0.6	Schnorbach et al., 2007	
Spirotetramat metabolites +	Melon	2.2	–	Schnorbach et al., 2006	
Spirotetramat metabolites +	Citrus*	0.9 <sup>(3)</sup>	–	Bocksch, 2008	
thiOphanat-methyl + carbendazim	Rape	–	2.3	Schatz, Wallner 2009	op
Teflubenzuron	Rape	21.7	0.9	Data from DAR	op
Teflubenzuron	Rape	149.8	–	Data from DAR	op
Thiacloprid	Rape	–	0.5	Schatz, Wallner 2009	op
Thiacloprid	Apple*	0.9	–	Skerl et al., 2009	esr

Compound	Crop	RUD (mg/kg) pollen	RUD (mg/kg) nectar	Reference	Data source
thiophanat-methyl	Rape	–	1.0	Schatz, Wallner 2009	op
Vinclozolin	Cherry*	4.1	–	Kubik et al., 1992	esr
Number of data		42	31		
Lowest value		0.0002	0.1429		
10th % value		0.3	0.6		
Median value		6.1	2.9		
90th % value		51.9	11.3		
95th % value		82.1	12.0		
Highest value		149.8	20.7		
10th % for downward spraying		0.6	0.6		
90th % for downward spraying		62.4	11.2		
10th % for up/sideward spraying		0.3	1.9		
90th % for up/sideward spraying		4.6	9.9		

– No value or no reliable value for RUD calculation; op, EFSA Opinion (EFSA PPR Panel 2012a) esr, External Scientific Report (Thompson, 2012).

Notes:

(1): The exact value is 0.0002417 mg/kg.

(2) The value was considered unrealistic by the study authors based on the fact that the results of the other subsamples of the same trial gave considerable lower residue concentrations. No other reasoning was given; therefore, as a worst-case assumption, this value was considered here.

(3): Two applications were performed.

\*Upwards/sideward spray technology.

**Table F2:** RUD values referring to an application rate of 1 mg/seed or 1 kg a.s./ha derived from seed dressing applications

Compound	Crop	RUD (mg/kg) based on seed dressing rate		RUD (mg/kg) based on application rate		Reference <sup>1</sup>	Data source
		Pollen	Nectar	Pollen	Nectar		
CGA322704	Rape	–	0.056	–	0.056	L	op
Clothianidin	Rape	–	–	–	0.111	1	op
Clothianidin	Rape	–	–	0.093	0.200	2	op
Clothianidin	Rape	0.002	0.002	0.020	0.020	7	op
Clothianidin	Rape	–	–	0.082	0.173	9	op
Clothianidin	Rape	–	–	0.066	–	10	op
Clothianidin	Rape	–	–	0.034	0.020	11	op
Clothianidin	Rape	–	–	0.071	0.088	12a	op
Clothianidin	Rape	–	–	0.093	0.037	12b	op
Clothianidin	Rape	–	–	0.032		A. Nikolakis et al., 2012	
Clothianidin	Rape	–	–	0.136	0.033	A. Nikolakis et al., 2012	
Clothianidin	Rape	–	–	0.247	0.035	A. Nikolakis et al., 2012	

Compound	Crop	RUD (mg/kg) based on seed dressing rate		RUD (mg/kg) based on application rate		Reference <sup>1</sup>	Data source
		Pollen	Nectar	Pollen	Nectar		
Clothianidin	Rape	–	–	0.063	–	A. Nikolakis et al., 2011	
Clothianidin	Rape	0.086	0.074	–	–	Cutler and Scott-Dupree, 2007	esr
Clothianidin	Rape	–	0.05	–	–	Wallner, 2009	esr
Clothianidin	Sunflower	0.011	–	0.122	–	3	op
Clothianidin	Sunflower	0.010	–	0.114	–	4	op
Clothianidin	Maize	–	–	0.083	–	Nikolakis et al., 2009	op
Clothianidin	Maize	–	–	0.115	–	8	op
Clothianidin	Maize	–	–	0.054	–	8b	op
Clothianidin	Maize	0.008	–	–	–	Staedtler T., 2009	st
Clothianidin	Maize	0.004	–	–	–	Ch. Maus et al., 2005 (E 319 2902–6)	st
Clothianidin	Maize	0.004	–	–	–	Ch. Maus et al., 2006 (E 319 2902–6)	st
Clothianidin	Maize	0.003	–	–	–	Ch. Maus et al., 2007 (E 319 2903–7)	st
Clothianidin	Maize	0.003	–	–	–	Ch. Maus et al., 2007 (E 319 2903–7)	st
Clothianidin	Maize	0.007	–	–	–	Kruipe, Hunt et al., 2012	esr
Clothianidin	Maize			0.118		R. Schöning, 2003	
Clothianidin	Maize			0.042		R. Schöning, 2004	
Clothianidin	Maize			0.295		R. Schöning, 2005	
Clothianidin	Maize	0.008				Classen C., 2009	
Clothianidin	Maize	0.012				Classen C., 2009	
Clothianidin	Maize	0.006				Classen C., 2009	
Fipronil	Maize	0.012		0.159		Kerl W., 2005	
RPA200766	Sunflower		0.077		0.105	Bocksch, 2009	
Imidacloprid	Rape	–	–	0.156	0.017	11	op
Imidacloprid	Rape	–	–	0.149	0.149	7	op
Imidacloprid	Rape	–	–	0.069	0.069	8	op
Imidacloprid	Rape	–	–	–	0.159	9	op
Imidacloprid	Sunflower	0.036	–	–	–	Laurent and Rathahao, 2003	esr
Imidacloprid	Sunflower	0.004	–	–	–	Bonmatin et al., 2005	esr
Imidacloprid	Sunflower	0.015	–	–	–	Bonmatin et al., 2003	esr
Imidacloprid	Maize	0.006	–	0.056	–	5	op

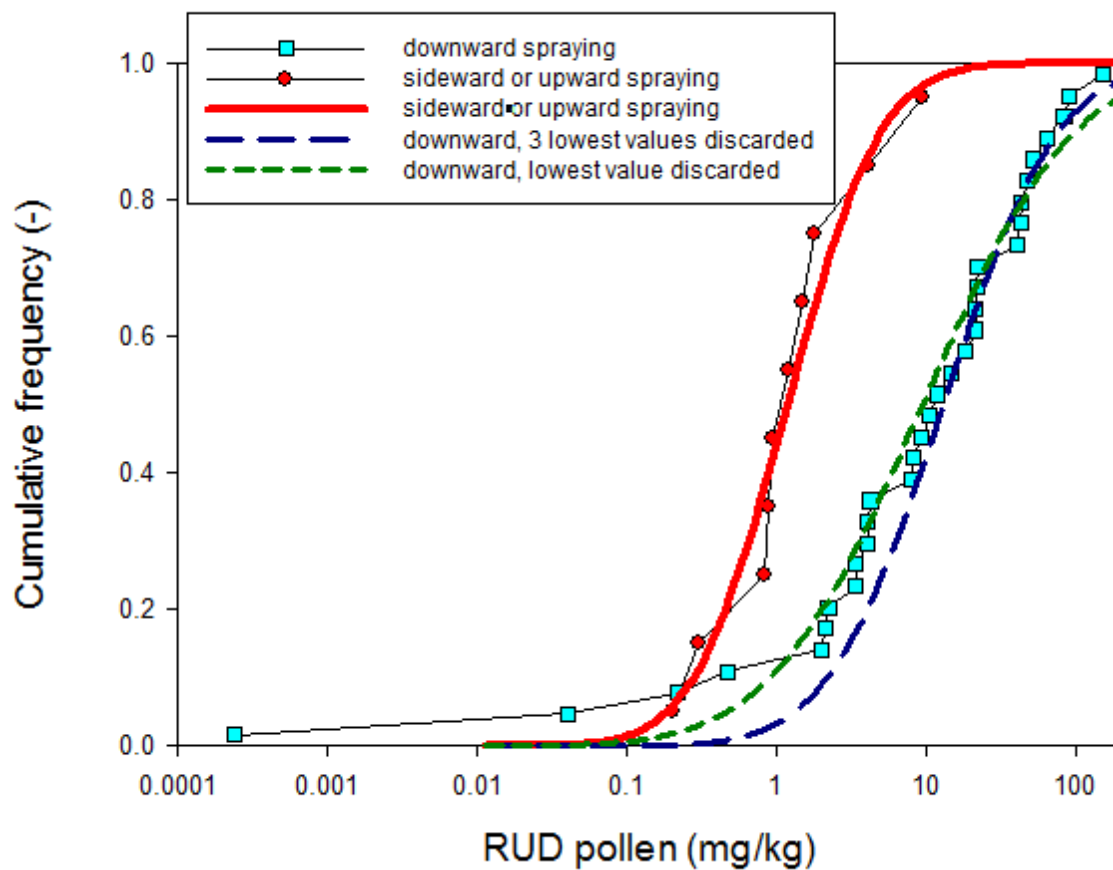
Compound	Crop	RUD (mg/kg) based on seed dressing rate		RUD (mg/kg) based on application rate		Reference <sup>1</sup>	Data source
		Pollen	Nectar	Pollen	Nectar		
Imidacloprid	Maize	0.006	–	0.056	–	6	op
Imidacloprid	Maize	0.002	–	–	–	Bonmatin et al., 2005	esr
Imidacloprid	Maize	0.003	–	–	–	Bonmatin et al., 2003, 2007	esr
Imidacloprid	Cotton	0.004	0.006	0.023	0.034	Knäbe, 2012	
Imidacloprid	Cotton		0.008 <sup>ef</sup>		0.045 <sup>ef</sup>	Knäbe, 2012	
Imidacloprid	Cotton	0.009	0.007	0.046	0.037	Knäbe, 2012	
Imidacloprid	Cotton		0.009 <sup>ef</sup>		0.046 <sup>ef</sup>	Knäbe, 2012	
Thiamethoxam	Rape	0.263	0.131	0.162	0.081	F	op
Thiamethoxam	Rape	–	–	0.242	–	Hargreaves N., 2007 (T003253-05-REG)	st
Thiamethoxam	Sunflower	0.006	–	0.039	–	H	op
Thiamethoxam	Sunflower	0.013	–	0.145	–	I	op
Thiamethoxam	Maize	0.002	–	–	–	Kruyep et al., 2012	esr
Thiamethoxam	Maize	0.013	–	–	–	AFSSA 2007	esr
Thiamethoxam	Maize			0.299		Hecht-Rost S., 2010 (20061138/F1-BZEU)	
Thiamethoxam	Maize			0.028		Hecht-Rost S., 2010 (20061138/F1-BZEU)	
Thiamethoxam	Maize			0.077		Hecht-Rost S., 2010 (20061138/F1-BZEU)	
Thiamethoxam	Maize			0.066		Hecht-Rost S., 2010 (20061138/F2-BZEU)	
Thiamethoxam	Maize			0.048		Hecht-Rost S., 2010 (20061138/F2-BZEU)	
Thiamethoxam	Maize			0.044		Hecht-Rost S., 2010 (20061138/F2-BZEU)	
Thiamethoxam	Maize			0.109		Hecht-Rost S., 2010 (20061138/F3-BZEU)	
Thiamethoxam	Maize			0.119		Hecht-Rost S., 2010 (20061138/F3-BZEU)	
Thiamethoxam	Maize			0.065		Hecht-Rost S., 2010 (20061138/F3-BZEU)	
thiamethoxam + CGA322704	Rape	0.2875	–	0.148	–	M	op
thiamethoxam + CGA322704	Rape	0.05	0.005	0.033	0.032	O	op
thiamethoxam	Rape	–	–	0.574	–	Hecht-Rost S., 2007	st

Compound	Crop	RUD (mg/kg) based on seed dressing rate		RUD (mg/kg) based on application rate		Reference <sup>1</sup>	Data source
		Pollen	Nectar	Pollen	Nectar		
+ CGA322704						(20051040/F2-BZEU)	
Thiamethoxam + CGA322704	Maize	0.022	–	0.213	–	Hecht-Rost S., 2007 (20051149/F1-BZEU)	st
Thiamethoxam + CGA322704	Maize	0.005	–	0.047	–	Hecht-Rost S., 2007 (20051149/F1-BZEU)	st
Thiamethoxam + cga322704	Maize	0.015	–	0.155	–	Hecht-Rost S., 2007 (20051149/F2-BZEU)	st
thiamethoxam + CGA322704	Maize	0.012	–	0.130	–	Hecht-Rost S., 2007 (20051149/F2-BZEU)	st
Thiamethoxam + CGA322704	Maize	–	–	0.079	–	Hargreaves N., 2007 (T003256-05-REG)	st
thiamethoxam + CGA322704	Maize	–	–	0.045	–	Hargreaves N., 2007 (T003256-05-REG)	st
Number of data		37	11	49	21		
Lowest value		0.0020	0.0024	0.0201	0.0166		
10th % value		0.0028	0.0048	0.0340	0.0201		
Median value		0.0091	0.0093	0.0823	0.0458		
90th % value		0.0416	0.0767	0.2187	0.1592		
95th % value		0.1213	0.1040	0.2758	0.1727		
Highest value		0.2875	0.1313	0.5739	0.2000		

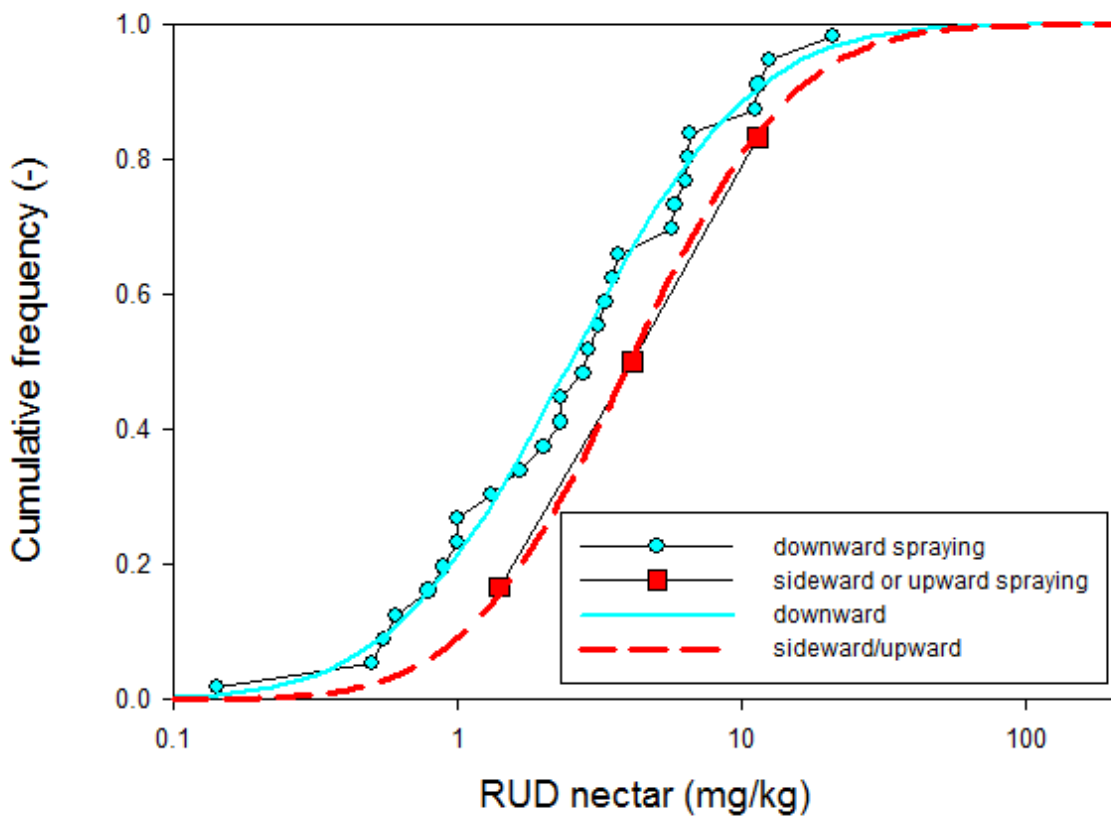
– No value or no reliable value for RUD calculation; op, EFSA Opinion (EFSA Panel on Plant Protection Products and their Residues (PPR), 2012a); esr, External Scientific Report (Thompson, 2012); st, EFSA statement (EFSA, 2012); ef, extrafloral nectar.

Note:

(1): Where a letter or figure appears in the column, see reference in the data source.



**Figure F1:** The cumulative frequency distributions of RUD values for pollen for downwards and side/upwards spraying. Points are measured cumulative frequency distributions and the lines are fitted lognormal distributions



**Figure F2:** The cumulative frequency distributions of RUD values for nectar for downwards and side/upwards spraying. Points are measured cumulative frequency distributions and the lines are fitted lognormal distributions

## Appendix G. PROTOCOL FOR PERFORMING FIELD STUDIES FOR HIGHER EXPOSURE TIERS

This appendix proposes protocols for higher exposure tiers for honey bees: firstly for higher tiers for the assessment of concentrations in nectar and pollen after spray applications, secondly for a higher tier for the contact exposure assessment after spray applications and thirdly for assessment of RUD values for nectar and pollen after dust deposition resulting from seed treatments and granule applications.

In a number of the exposure flow charts in Appendix N. there is a higher-tier option to assess the concentration in nectar and pollen under realistic field conditions. This is the case for the flow charts for:

- the treated crop after spray applications, seed treatments or granule applications
- permanent crops in the year after spray applications or granule applications
- succeeding annual crops after spray application, seed treatments or granule applications in the treated crop.

The aim of such experiments is to assess the spatial variation of the peak concentration in nectar and pollen for the area of use of a substance for a certain use of application (e.g. spraying of a dosage of 0.5 kg/ha in cherries two weeks before flowering). The procedure is (i) to measure these concentrations at a number of locations in the area of use (see details below), (ii) to use the data as input for the EFSA calculator tool described in Section 1 of Appendix N. In principle this is the highest tier that is possible in the exposure assessment because it is closest to the reality.

In view of time limitations we are unable to provide guidance at a very detailed level. Therefore we recommend using the principles provided in earlier guidance documents on related subjects (DG Agriculture, 1997); (OECD, 2007), (OECD, 2009);(DG SANCO, 2009) (DG SANCO, 2011) keeping of course the aim of the study in mind.

DG SANCO (2009) proposes the following residue definition for monitoring and risk assessment for honey: the sum of parent and all metabolites included in the residue definition for monitoring in plants and animal products. Since not much experience has been gained so far, it is proposed to adopt this method. The sensitivity (i.e. limit of quantification and detection) of the analytical methods that are used in the residue studies should be checked in order to ensure that they are low enough to detect residue levels that exert toxic effects to honeybees.

Sampling times depend on the purpose of the study. In the case of spray or granule applications before flowering of the plant, sampling can start of course only after flowering has started. In the case of spray or granule applications during flowering, sampling has to start one day before application of the substance and has to be performed immediately after application and on at least three additional sampling times. On analysis the residues should show a clear decline over the sampling period. If this doesn't occur, then the study should be repeated as it is key that the peak residue with respect to time is determined. In case of measurements in permanent crops one year after application or in succeeding annual crops or in case of measurements in the treated crop after seed treatments, sampling has to be equally distributed over the flowering period because it is a priori unknown when the highest concentrations will occur.

The selection of the locations and the number of locations has to be tailored to the purpose of the study, i.e. to assess the spatial variation of the RUDs in the area of use of the substance. This spatial variation is used to assess a certain percentile (usually 90<sup>th</sup>) of the daily residue intake rate using the EFSA calculator tool based on Eqn N5. This percentile of the intake rate is likely to be related to the corresponding percentile of the RUDs: e.g. the 90<sup>th</sup> percentile daily residue intake rate of the different bee species can probably only be assessed appropriately if the 90<sup>th</sup> percentile RUD values of nectar and/or pollen have also been assessed with enough certainty. In general the locations should be distributed over the area of use. The number of locations should ensure that the required percentile is assessed with enough certainty. For example, in case of a 90<sup>th</sup> percentile we propose to perform studies

for at least five randomly selected locations in the area of use of the substance because the highest of five ranked values of a sample population is the 90<sup>th</sup> percentile. Using less than five locations is then unlikely to lead to the required certainty. No experience has been gained so far with this recommendation so there is need for this guidance to develop further in future.

It is considered acceptable to assess the concentrations in nectar in the treated field by sampling bees that are actively foraging in the treated crop (via e.g. a hoover) and by analysing the concentration in the honey sacks of these bees. It is recommended to sample approximately 20 bees in triplicate on each sample time. The contents of the honey sacks of these approximately 20 bees can be mixed before analysis but the triplicate samples should be analysed separately to assess the uncertainty of the sampling method. It is of course also acceptable to sample the nectar directly from the plants if this is feasible (also here it is recommended to take approximately 20 samples in triplicate).

The pollen in the treated field can be directly sampled from the plants. It is recommended to collect pollen from approximately 20 plants in triplicate and to analyse the triplicate samples separately.

The effect assessment is based on the daily uptake of nectar and pollen (see [Appendix J](#)). The daily uptake of nectar is calculated as the quotient of the sugar demand of the species divided by the sugar content of the nectar. Therefore it is necessary to measure in each nectar sample not only the concentration of the substance but also the sugar content. It is likely that in the foreseeable future the daily uptake of pollen will be based on the quotient of the protein demand of the species divided by the protein content of the pollen. Therefore notifiers may consider to measure besides the concentration of substance in the pollen also the protein content of each pollen sample.

For spray or granule applications with more than one application in the growing season of the crop, it is possible that the substance accumulates in the crop or the soil and it is likely that measured concentrations in pollen and nectar are then highest after the last application. It is recommended to measure the concentrations in nectar and pollen after the last application.

In principle the field exposure studies as described above can also be used for refining the default DT<sub>50</sub> of 10 days which is used for calculating the time-weighted average exposure for consumption of nectar and pollen entering the hive. However, in such a case the courses of time of the concentrations in nectar and pollen (and preferably also of the sugar content of the nectar) have to be measured sufficiently accurate to assess the decline in the concentrations. This may require measurements at additional sampling times. The measured decline can be fitted to a first-order decline from which the TWA-concentrations can be calculated (with Eqn N7) or the TWA-concentrations can be obtained by numerical integration of the measurements (i.e. via the area under the curve) if the measurements cannot be described well by a first-order decline. When this refinement is used, the TWA concentrations have to be assessed for all field experiments and the 90<sup>th</sup>-percentile TWA concentration has to be selected from all these field experiments. So it is well possible that the 90<sup>th</sup> percentile peak concentration comes from another location than the 90<sup>th</sup> percentile TWA concentration.

This guidance refers to concentrations in nectar and pollen for the different types of plants. As described in section 7.5, this is based on a conservative approach not considering the dilution of these concentrations in the hives. In view of our recommendation to include this dilution in the exposure assessment in the foreseeable future, measurements should include both the concentrations in the treated field and the concentrations in honey sacks and in pollen baskets of bees returning to hives located at the edge of treated fields and also information on surface areas of attractive flowering plants in the foraging area during the study should be collected.

As described in [chapter 7](#), one of the higher tier options for the contact exposure assessment after spray applications is to perform five field studies to assess the 90<sup>th</sup> percentile case for the cumulative frequency distribution of the mass per bee due to contact exposure (i.e. the highest exposure of these five studies). In each of these studies the aim is to measure the residues on honey bees foraging the crop during or immediately after application. The key issue is that it is the residues on the bees and

hence the residue analysis should exclude honey sacs or pollen sacs. At least 100 honey bees should be sampled immediately after the spray application and at time intervals of no more than 10 min until approximately one hour afterwards. The honey bees should be sampled in the treated field using e.g. a Hoover. The residue on each individual forager should be determined because it is the aim to assess the cumulative frequency distribution of the individual foragers. Alternatively, contact exposure may be seen as a generic issue and hence a generic approach using a tracer may be used instead of the substance considered.

The flow charts for field margins and adjacent crops after seed treatments and granule applications contain the option to measure RUD values for relevant crops after dust deposition. In these flow charts, the RUD is not considered a major driver for the 90<sup>th</sup> percentile case. Therefore the aim of these measurements is to assess an average or median RUD for the crop considered. No experience has been gained so far with these experiments. Therefore it is tentatively proposed to perform two field experiments (preferably with two different field crops for the field margins and with this adjacent crop) and use the average RUD of the two.

These RUD values have to be based on the combination of measurements of (i) the dust deposition onto bare soil, and (ii) the resulting concentrations in nectar and pollen. The deposition onto bare soil is needed because the RUDs for field margins and adjacent crops cannot be based on the dose for the treated crop because the deposition onto these types of plants is highly variable and because lower tiers of the flow charts refine this deposition. It may also be useful to measure the dust deposition on the plants considered to obtain additional information on the relationship between deposition onto bare soil and onto the flowers of the crop because this information is yet scarce. The concentrations have to be measured immediately after application and on at least three additional sampling times. On analysis the residues should show a clear decline over the sampling period. If this doesn't occur, then the study should be repeated as it is key that the peak residue with respect to time is determined as a basis of the RUD values.

The RUD values should be calculated as the quotient of the concentration in nectar or pollen (in mg/kg) divided by the mass deposited per surface area of bare soil (in kg/ha). In principle the course of time of the RUD values can be used to refine the DT<sub>50</sub> of 10 days which is used for calculating the time-weighted average exposure for consumption of nectar and pollen entering the hive. See for further guidance the proposed procedure above for the spray applications.

## Appendix H. ASSESSMENT OF SPRAY DRIFT AND DUST DRIFT DEPOSITION ONTO FIELD MARGINS AND ADJACENT FIELDS

### Introduction

In this Guidance Document deposition of sprays and dust outside the treated field (field margins or adjacent crops) has to be assessed at several places. This appendix describes how this should be done.

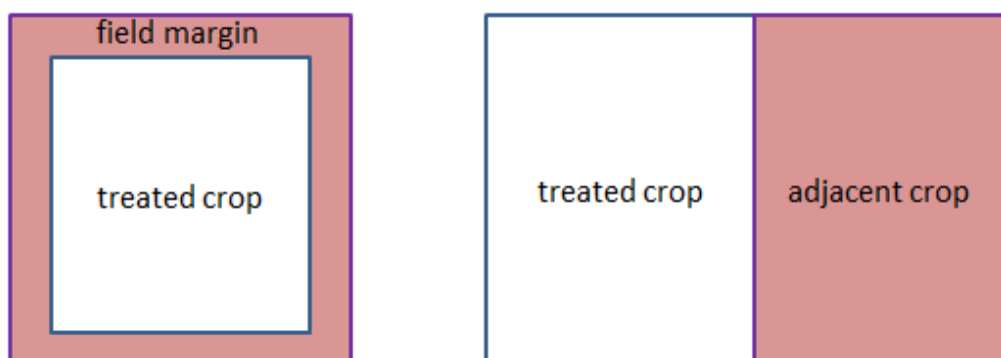
Based on (EFSA, 2004) we use the following terminology:

- drift is the process by which liquid or solid particles are carried out of the treated area by wind or the air stream of the application equipment,
- spray drift is drift of liquid particles applied via a spray boom,
- dust drift is drift of solid particles released during non-spray applications (seed treatments or granules).

The target of the exposure assessment for the field margin is the average deposition onto attractive plants in the whole field margin of a treated field because there are a priori no reasons to assume that foragers from a hive at the edge of the treated field would preferably forage more on contaminated parts of the field margin than on non-contaminated parts (e.g. because they were upwind during application). Similarly, the target for the adjacent crop is the average deposition onto the whole adjacent crop field because there are a priori no reasons to assume that foragers from a hive at the edge of the treated field would preferably forage more on the contaminated strip of the adjacent crop that is closest to the treated field.

Both spray and dust drift deposition decreases with the distance from the treated field. So the downwind width of the margin or the adjacent field will influence the average deposition. We propose tentatively a width of 2 m for the field margin and of 50 m for the adjacent field and consider these to be conservative values. We recommend underpinning or refine these 2 and 50 m by geostatistical analyses.

We use the geometry as shown in Figure H1 as a conceptual model for the effect of the wind angle on the average deposition: field margins will usually surround the whole field and an adjacent crop will usually be only on one side of the treated field. We recommend performing geostatistical analyses to underpin or refine this simplified geometry.



**Figure H1:** Simplified geometries of (left) a combination of treated crop and a field margin and (right) a combination of a treated crop and an adjacent crop.

In the EU assessment of the spray drift deposition onto field margins for non-target terrestrial organisms, the first 1 and 3 m of the off-field area is ignored for field crops and orchards, respectively (see p. 22 of EC (2002b)). This is based on risk management considerations. However in our assessment of the spray and dust drift deposition in the field margin it is not defensible to ignore these first 1 and 3 metres because the bees do not know that they should avoid collecting nectar and pollen from these plants.

## **Spray drift deposition**

### **Field margins**

Assessment of the spray drift deposition onto field margins is needed for the flow charts on concentrations in nectar and pollen and on contact exposure. This section describes how this should be done.

Spray drift deposition is strongly influenced by the spray drift equipment, the wind angle and the wind speed at the time of application (van der Zande et al., 2012). Spray drift deposition measurements are usually carried out downwind of treated fields along lines whose angle with the wind direction is less than 30°, so considering only 60° of the in total 360°. Deposition upwind can be considered negligibly small (180 of the 360°) and deposition onto the remaining 120° downwind will be smaller than for the directions whose angle with the wind direction is less than 30° (Van de Zande et al., 2012). So the average deposition on field margins surrounding a rectangular field will be between 1/6 and 1/2 of deposition measured in directions whose angle with the wind direction is less than 30°. As a reasonable assumption we propose to assume 1/3 (average of 1/6 and 1/2). This assumption needs of course further underpinning or refinement. Therefore, we recommend performing a modelling study in which the spray drift deposition onto field margins is simulated as a function of a stochastic wind angle and a stochastic wind speed from which the 90<sup>th</sup> percentile spray deposition case can be derived (see van der Zande et al., 2012, for an example of such a study for spray deposition on surface water). This modelling study should also consider the effect of repeated applications because these probably influence the assessment of the 90<sup>th</sup> percentile case (van der Zande et al., 2012).

Candolfi et al. (2001) recommended using spray drift tables by (BBA, 2000) for spray deposition on field margins. These tables give deposition percentages as a function of distance from the treated field for field crops, fruit crops, grapevine, hops and vegetables. There are tables for a single application and 2-3-4-5-6-7 applications. The deposition percentages decrease with the number of applications. Van de Zande et al. (2012) made stochastic calculations on spray drift deposition onto surface water considering a stochastic wind angle and a stochastic wind speed. They showed that a decrease of the 90<sup>th</sup> percentile deposition with the number of applications will only occur if the concentrations of the different applications sum up. They showed furthermore that if these concentrations do not sum up (because of rapid dissipation of the substance), the deposition percentage should increase with the number of applications because more applications give more possibilities of obtaining unfavourable meteorological conditions with respect to spray drift. Concentrations in nectar and pollen in plants show usually rapid dissipation after spray applications (EFSA Panel on Plant Protection Products and their Residues (PPR), 2012a). So the decreasing drift deposition with increasing number of applications as recommended by Candolfi et al. (2001) seems indefensible; instead the drift deposition should increase with the number of applications.

Furthermore the drift deposition tables from BBA (2000) were based only on measurements in Germany and there have been significant developments in the field of harmonisation of drift deposition in the EU (Huijsmans and van de Zande, 2011). Therefore, we recommend improving the estimates of deposition of spray drift by analysing all spray drift data available within the EU. This analysis should also consider the effect if the plants in field margins and adjacent crop may catch more drift than bare soil (most drift deposition measurements are carried out on bare soil or in a short crop).

In the absence of better alternatives, we propose for the time being the following procedure for default conservative spray drift depositions onto the field margins: both for single and repeated applications take the spray drift deposition figures by Candolfi et al. (2001) for a single application at distance of 1 m for downward spray applications (in field crops) and at a distance of 3 m for sideward and upward applications (in fruit crops and grapevine): 2.77% for field crops, 29.2% for early fruit, 15.73% for late fruit, 2.7% for early grapevine, 8.02% for late grapevine, and 19.33% for hops. For the assessment of concentrations in nectar and pollen entering the hive, these figures have to be multiplied by 1/3 to account for the effect of the wind angle on the deposition as described at the start of this section. This gives 0.92% for field crops, 9.7% for early fruit, 5.2% for late fruit, 0.90% for early grapevine, 2.7% for late grapevine, and 6.4% for hops. For the contact exposure assessment this multiplication with 1/3 does not apply as explained at the end of Appendix M. Given all the complications described above, we are at present unable to assess whether this interim solution is on the conservative or optimistic side for single or repeated applications but it is our best guess at this moment.

### Adjacent crops

Assessment of the spray drift deposition onto adjacent crops is needed for the flow chart for concentrations in nectar and pollen. This section describes how this should be done.

For the adjacent crops the geometry in Figure H1 shows that the effect of the wind angle leads to another type of statistics. For the field margin, the wind angle has no effect on the average deposition because the field margin surrounds the whole field so the angle does not matter. However, if the adjacent crop is upwind during application, there is no deposition at all. If this crop is downwind, then the wind angle may vary 180° whereas the measurements are usually carried out for the 60° with the highest deposition (angle with wind direction less than 30°; see previous section). So for the adjacent crop the wind angle leads to a probability density function of deposition values (of which 50% are zero values considering only a single application). So if we use such measurements as a basis for the average drift deposition on the whole adjacent field, we have to be aware that these figures represent only the highest 60° of the 360° that is possible, so the highest 16%, ie above the 84th percentile when considering the wind angle as the only stochastic variable.

To assess the exposure of the 90<sup>th</sup> percentile hive, a stochastic modelling study is needed considering a stochastic wind angle and a stochastic wind speed similar to the approach described for the field margins. As indicated in section 2.5 of Appendix N., the 90<sup>th</sup> percentile hive may be linked to a 50<sup>th</sup> percentile spray drift case (e.g. if a relevant attractive crop is present only at the border of 20% of treated fields). So the modelling study has to calculate the full frequency distribution and a table should be generated from this from which the desired percentile spray drift deposition can be derived. The modelling study has to include repeated applications because these influence such frequency distributions (Van de Zande et al., 2012).

The flow chart for concentrations in nectar and pollen collected from adjacent crops needs default conservative spray drift deposition figures. In the absence of better information, we propose to use for the time being both for single and repeated applications the spray drift deposition figures by Candolfi et al. (2001) for a single application. For adjacent fields thus the average deposition over the first 50 m was to be derived from these figures. This resulted in 0.33% for field crops, 6.6% for early fruit, 3.1% for late fruit, 0.47% for early grapevine, 1.43% for late grapevine and 4.1% for hops.

As for the field margins, we are at present unable to assess whether this proposed interim solution is on the conservative side or on the optimistic side. However, the deposition is likely to be much less than that for the field margins because (i) the average over 50 m is less than the deposition onto a 2-m wide field margin and (ii) only a fraction of the treated fields has downwind adjacent attractive crops at the time of application. So the spray drift assessment for the adjacent crop is much less critical than that for the field margins (in the short term; in the long term it may be the opposite as described in [Appendix N](#)).

## **Dust drift deposition**

### **FIELD MARGINS**

#### **Seed treatments**

Assessment of the dust drift deposition onto field margins is needed for the assessment of exposure to dust for the seed treatments. This section describes how this should be done.

The deposition of dust drift is the result of (i) emission and (ii) transport through the air and deposition onto the plants. So there are two questions to be addressed: (i) which factors influence dust emission from the application equipment, and (ii) which factors influence dust deposition onto the plants in the field margins ?

The dust emission is strongly influenced by (i) the sowing equipment, (ii) use of deflectors in case of pneumatic sowing, (iii) the abrasiveness of the seed coating and the granules as determined in the Heubach test and (iv) the concentration of active ingredient in the dust released in the Heubach test (EFSA Panel on Plant Protection Products and their Residues (PPR), 2012a). Mechanical sowing gives much less emission than pneumatic sowing. In case of pneumatic sowing, use of deflectors decreases the emission strongly. The higher the amount of dust released in the Heubach test, the higher the emission of dust. The higher the concentration of the active ingredient in this dust, the higher the emission of the active ingredient.

Dust deposition is strongly influenced by (i) wind angle and (ii) the ‘filtering capacity’ of the crop. The effect of the wind angle is obvious: there will be little deposition upwind and much deposition downwind. The larger the filtering capacity the higher the deposition in the crop will be. The effect of the wind speed on the deposition is as yet unclear.

The draft SANCO Guidance Document for seed treatments provided the following conservative default dust deposition (mass of substance per surface area of the field margin expressed as percentage of the mass of substance applied per surface area of treated field) for pneumatic suction drills equipped with deflectors: 0.56% for maize, 0.22% for oil seed rape, 0.33% for cereals and 0.001% for sugar beets. Based on expert judgement we expect deposition for drills without deflectors to be 10 times larger, so 5.6% for maize, 2.2% for oilseed rape, 3.3% for cereals and 0.01% for sugar beets. All these values refer to deposition onto bare soil.

Field experiments were conducted in Germany with adjacent flowering oil seed rape in 2009, 2010, 2011 and 2012, and with adjacent flowering Sinapis in 2009, 2011 and 2012. In these experiments the deposition in petri dishes on bare soil (average of 1-5 m distance) was compared to the deposition on the flowers in the adjacent crop. The results showed that the deposition in oil seed rape was 1.8 to 2.8 times higher than in the petri dishes and that in Sinapis was 1.2 to 1.6 times higher than in the petri dishes (Pistorius J, JKI, personal communication, 2013). In view of this limited data base we propose to assume that the deposition on plants in field margins is three times higher than measured on bare soil (i.e. the highest value 2.8 rounded to 3). The draft SANCO Guidance document for seed treatments proposes to use a factor 13 instead of this factor 3. This was based on measurements with vertical gauze nets in which the deposition between 40 and 90 cm height was measured. These gauze nets intend to mimic 3-dimensional structures such as hedgerows and trees. So it is considered appropriate to use the factor 13 for deposition on hedgerows and the factor 3 for deposition on field margins with annual vegetations both for the assessment of the consumption of nectar and pollen and the assessment of the contact exposure. The consequence of the 90<sup>th</sup> percentile exposure assessment goal is then that this factor 13 should be used if at the application time more than 10% of the treated crop fields have attractive flowering hedgerows at the edge of the treated field and the factor 3 if this percentage is less. We expect that for most crops and application times less than 10% of the treated field have attractive flowering hedgerows so it is recommended to use this factor 3. However, it is recommended to assess the occurrence of attractive flowering hedgerows based on geostatistical

analyses so that this assumption can be tested and results used for future improvement of this guidance.

For the assessment of concentrations in nectar and pollen entering the hive it is furthermore proposed to multiply the dust deposition with 1/3 to account for dilution of the concentrations in the field margin because the average deposition is lower than in downwind direction (same reasoning as for spray drift deposition onto field margins). For the contact assessment this dilution factor is not considered as explained at the end of [Appendix M](#).

This dilution factor of 1/3 is a reasonable assumption that should be underpinned or refined based on further research. Therefore we recommend performing studies using calibrated physical models in which the dust deposition onto field margins is simulated as a function of wind speed and wind angle (see EFSA, 2004, for examples of such model calculations for deposition of dust on surface water). Stochastic simulations with such models can then be used to obtain a more realistic assessment of the 90<sup>th</sup> percentile deposition (e.g. by multiplying the results of the proposed well-defined experiments with an appropriate factor). See van der Zande et al. (2012) for an example of a similar stochastic simulation for spray drift deposition on surface water.

In the simulation studies recommended above, the variation between different Heubach-AI should also be included (if possible) and the overall desired X<sup>th</sup> percentile should be assessed considering the combined effects of variability in the Heubach-AI and wind angle and windspeed because only this combination will describe exposure of the total spatial population of hives adequately. So the simplified approach to use only the Heubach-AI value to assess the percentiles should be seen as a conservative approach which can be made more realistic when science in this field progresses.

So for the assessment of concentrations in nectar and pollen entering the hive, the dust deposition values for equipment with deflectors are 0.56% for maize, 0.22% for oil seed rape, 0.33% for cereals and 0.001% for sugar beets; the values for equipment without deflectors are 5.6% for maize, 2.2% for oil seed rape, 3.3% for cereals and 0.01% for sugar beets.

For the contact exposure assessment, all dust deposition values are three times higher because the factor 3 dilution for averaging over all wind directions does not apply (see end of Appendix M). So for equipment with deflectors 1.7% for maize, 0.66% for oil seed rape, 0.99% for cereals and 0.003% for sugar beets; the values for equipment without deflectors are 17% for maize, 6.6% for oil seed rape, 9.9% for cereals and 0.03% for sugar beets.

## Granule applications

Assessment of the dust drift deposition from granule applications onto plants in field margins is needed for the assessment of concentrations in nectar and pollen and for the contact exposure assessment. This section describes how this should be done.

In addition, for the granule applications, the dust emission is strongly influenced by the application equipment: a spinning disc gives considerably less emission than a boom spreader (EFSA, 2004).

We propose to base the default conservative dust depositions from granules on simulations by EFSA (2004) for worst-case depositions onto surface water. The highest value reported by EFSA (2004) was 3.2% of the dose (deposition defined as the mass of substance deposited divided by the surface area of water and dose defined as mass of substance applied per surface area of treated field). We propose to multiply by 3 to account for the filtering capacity of the plants in the field margin and to divide by 3 to account for averaging over the different wind directions (the latter only for the concentrations in nectar and pollen entering the hive, not for the contact exposure assessment as explained at the end of Appendix M.). These factors 3 are preliminary figures that should be underpinned by further research.

So for the assessment of the concentrations in nectar and pollen entering the hive a default dust deposition from granules of 3.2% should be used and for the contact exposure assessment 9.6% should be used.

## ADJACENT CROPS

### Seed treatments

Assessment of the dust drift deposition from seed treatments onto adjacent crops is needed in the flow chart in Figure N10. This section describes how this should be done.

Based on the measurements of dust deposition as a function of distance to the treated field as shown in Figures J3 and J5 of EFSA Panel on Plant Protection Products and their Residues (PPR) (2012a), we propose as a conservative assumption that the dust deposition declines exponentially with distance to the treated field and that the deposition at 20 m distance is 50% lower than at the edge of the treated field. It then can be calculated that the average deposition on a 50 m wide adjacent field is 48% of the deposition at the edge of the treated field. So we propose to use for the conservative dust depositions for the assessment of concentrations of nectar and pollen entering the hive the figures provided in the draft SANCO Guidance Document for seed treatments (0.56% for maize, 0.22% for oilseed rape, 0.33% for cereals and 0.001% for sugar beets for equipment without deflectors) multiplied by 0.48; this gives 0.27% for maize, 0.11% for oilseed rape, 0.16% for cereals, 0.0005% for sugar beets and 0.27% for other crops. Based on expert judgement we expect deposition for drills without deflectors to be 10 times larger. Please note that no filtering factor for the adjacent crop is proposed because it is expected that the increased catchment of dust by the crop plants does not apply to the average deposition of a 50-m wide adjacent field (the assumption of 50% lower deposition at 20 m distance implies that more than 80% of the dust mass emitted from the treated field is deposited onto the adjacent crop, so it is then inconsistent to assume that there is a filtering factor of 3).

In addition, field measurements on dust deposition are commonly carried out for the wind direction by no more than 30°. As described in [Appendix N](#), we have eliminated the upwind wind directions already in the selection of the X<sup>th</sup> percentile in box 4 of Figure N12. So the problem left here is to assess how these field measurements should be used. As described before, the target is the average concentration over the full width of the adjacent field, so from the field measurements the average deposition over 50 m have to be derived. Then there is the problem left that the target is the X<sup>th</sup> percentile of all downwind adjacent attractive crops and the selected sowing equipment while we have already taken the X<sup>th</sup> percentile of the Heubach-AI values. So here we have the problem of finding a percentile X of a quantity that is a function of two variables ((i) Heubach AI and (ii) the combination of wind angle and wind speed) which have each their probability density functions. To solve this problem, we need information on the probability density functions of the two variables and their interaction which is not readily available. Therefore we propose as a conservative interim solution to use simply the measured average deposition over 50 m width of the adjacent field directly.

### Granule applications

A conservative default dust drift deposition value for granule applications and adjacent crops is needed in the corresponding flow chart for concentrations in nectar and pollen. This section describes how this is derived.

We propose to based the default conservative dust depositions on the 3.2% derived from EFSA (2004). We propose to multiply by 0.48 get the average deposition onto the first 50 m. So we get  $3.2 \times 0.48 = 1.5\%$  for the default dust deposition of granules onto adjacent crops. As for the seed treatments, there is no need to account for the filtering factor over this width of 50 m.

**SUMMARY OF CONSERVATIVE DEFAULT DEPOSITION PERCENTAGES**

Table H1 gives an overview of the default deposition percentages to be used for the different systems. The highest deposition percentages are found for the contact exposure assessment for the field margins because there is as yet no justification to average these over the surface area of the field margins (see end of [Appendix M](#) for justification). Please note that there is no column for the contact exposure assessment for adjacent crops because this is assumed to be always covered by the contact exposure assessment for the field margins.

**Table H1:** Conservative default deposition percentages for spray drift and dust drift to be used for the different combinations of application technique and types of plants.

Application type	Crop	Default deposition (%) to be used for		
		concentrations in nectar and pollen entering the hive		contact exposure assessment
		field margins	adjacent crops	field margins
Spray applications (spray drift)	Field crops	0.92	0.33	2.8
	Orchard – early stage	9.7	6.6	29.2
	Orchard – late stage	5.2	3.1	15.7
	Grapevine – early stage	0.90	0.47	2.7
	Grapevine – early stage	2.7	1.43	8.0
	Hops	6.4	4.1	19.3
Seed treatments (dust drift)	Maize with deflector	0.56	0.27	1.7
	Maize without deflector	5.6	2.7	17
	Oil seed rape with deflector	0.22	0.11	0.66
	Oil seed rape without deflector	2.2	1.1	6.6
	Cereals with deflector	0.33	0.16	0.99
	Cereals without deflector	3.3	1.6	9.9
	Sugar beets with deflector	0.001	0.0005	0.003
	Sugar beets without deflector	0.01	0.005	0.03
Granule applications (dust drift)	All crops	3.2	1.5	9.6

Before side shoot formation (BBCH < 20), hops are cultivated like an arable crop, therefore the value for field crops should be considered at this early stage.

## Appendix I. ASSESSMENT OF THE PERCENTILE OF A SUBPOPULATION THAT CORRESPONDS TO A PRESCRIBED PERCENTILE OF THE TOTAL POPULATION

In various parts of the assessment of the concentrations in nectar and pollen entering the hive in [Appendix N](#), there is the problem of how to assess a percentile of a subpopulation (e.g. in the flow charts of Figures N6, N8, N10, N11 and N12). This appendix explains how this should be done.

Let us consider a statistical population of a certain quantity  $Z$ . Let us assume that we can divide this population into  $n$  subpopulations which are ranked based on their  $Z$  values in such a way that all  $Z$  values of subpopulation 1 are smaller than those of subpopulation 2, all  $Z$  values of subpopulation 2 are smaller than those of subpopulation 3, etc.

Let us assume that we want to know the 90<sup>th</sup> percentile of  $Z$  by sampling only one of these subpopulations (for efficiency reasons). The question is then what percentile of the subpopulation should be assessed to obtain this overall 90<sup>th</sup> percentile. For example, if the subpopulation covers all values between the 85<sup>th</sup> and the 95<sup>th</sup> percentile, then it will be clear that we need the 50<sup>th</sup> percentile of the subpopulation to obtain the overall 90<sup>th</sup> percentile. This scaling procedure can be generalised to the following equation:

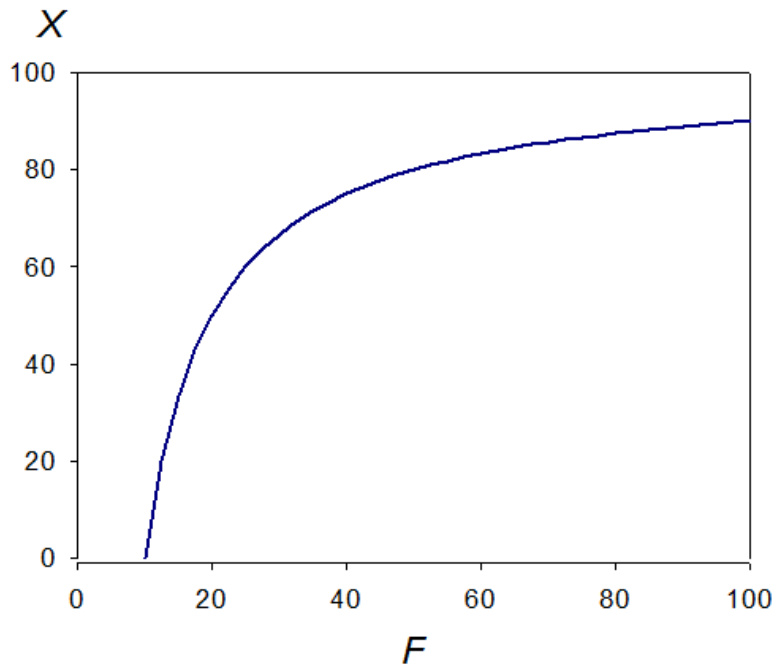
$$X = 100 \frac{90 - x_{low}}{x_{high} - x_{low}} \quad (I1)$$

where  $X$  is the percentile of the subpopulation corresponding to the overall 90<sup>th</sup> percentile,  $x_{low}$  is the percentile of the total population corresponding with the lowest value of the subpopulation and  $x_{high}$  is the percentile of the total population corresponding with the highest value of the subpopulation. So for the above example,  $x_{low} = 85$  and  $x_{high} = 95$ , so  $X = 50$ .

Often the 90<sup>th</sup> percentile will be located in the subpopulation with the highest  $Z$  values. For such cases it is interesting to write  $X$  as a function of the percentage of  $Z$  values that is present in this subpopulation, which is further called  $F$ . So  $F$  is defined as  $F = 100 - x_{low}$  and  $x_{high} = 100$ . This gives the following expression for  $X$ :

$$X = 100 \frac{F - 10}{F} \quad (I2)$$

Figure I1 shows that  $X$  increases with  $F$  and that, of course, it becomes 90 if  $F$  approaches 100 (so the subpopulation becomes the full population). If  $F$  is smaller than 10%, then  $X$  no longer has any meaningful value because the subpopulation consists of less than 10% of the values of  $Z$ , so the 90<sup>th</sup> percentile is then determined by another subpopulation. Figure I1 can be illustrated by considering the easy case of  $F = 20$ , so the subpopulation of the highest values is 20% of the total population. In such case Eqn I2 and Figure I1 give  $X = 50$ , which is the expected value: if only the highest 20% of all values are considered, then the 50<sup>th</sup> percentile of these highest 20% should give the overall 90<sup>th</sup> percentile.



**Figure I1:** The relationship between  $X$  and  $F$  as described by Eqn I2

## Appendix J. SHORTCUT VALUES FOR THE ESTIMATION OF THE ORAL EXPOSURE VIA NECTAR AND POLLEN CONSUMPTION

### 1. Introduction

This appendix contains the shortcut values (SVs) to be used in the risk assessment for the oral route of exposure via nectar and pollen consumption and explains how they were calculated. The SVs were derived considering information on feed (nectar and pollen) consumption and worst-case pesticide residue levels (RUDs or default 1 mg/kg) of the feed items. SVs are to be used in the lower tiers (screening step and first tier) of the risk assessment schemes and these values can be refined for the second tier with compound and/or crop specific data.

### 2. Categories to be considered

Considering the differences in feed consumption, separate SVs were calculated for adults and larvae of honey bees (HB), bumble bees (BB) and solitary bees (SB). Owing to differences in feed consumption, the category for adult honey bees was further divided into foragers and nurse bees. Owing to the differences in the foraging strategy of honey bees and bumble bees compared with solitary bees (for further explanations see section 3.1, below) the adult (forager) category of honey bees and bumble bees was further divided into acute and chronic subcategories and, as a result, different SVs were calculated for the acute and for the chronic risk assessments. It should be noted that this separation (acute or chronic) refers only to adult (forager) honey bees and bumble bees. For nurse honey bee, adult solitary bee and larval stages of all kind of bees, only one SV was calculated (no difference in feeding strategy of a particular day to another). Therefore, in these cases the same SV will be used for the acute and chronic risk assessment.

As regards the default pesticide residue levels (RUDs), fundamental differences were identified between values derived from downwards (DW) spraying (e.g. horizontal boom sprayer) and those derived from sideward/upwards (SUW) spray applications (e.g. air assisted orchard sprayer). Therefore, different sets of SVs were calculated for downwards and side/upwards spray applications. For situations where the root uptake is the predominant process of the exposure of the crops (i.e. pre-emergence applications), the default residue level of the feed items of 1 mg/kg was used for the treated crop scenario; therefore, a separate set of SVs were calculated for these cases.

The crop plants (i.e. the treated crop, adjacent crop and succeeding crop/permanent crop in the next year) are also allocated into three further categories depending on whether they attractive for both nectar and pollen or only one of these feed items for the bees. For crops that are not attractive for nectar and foraged only for pollen (e.g. maize does not produce nectar), SVs for forager honey bees were not calculated as they do not consume pollen (nurse bee covers the category of adult honey bee). Also, acute and chronic were not distinguished (for bumble bee adults) since these terms are linked only to nectar consumption. Separate sets of SVs were calculated for the scenarios for weeds in the field, plants at the field margin considering differences in the input parameters required for the calculations (for further explanations see section 3, below). No separate calculations were necessary for the scenarios for adjacent crop and succeeding crop/permanent crop as the input parameters required for the calculations were the same as for the scenarios for treated crop for application after emergence (for sprays it is the downwards spraying) or pre-emergence applications, respectively.

### 3. Methodology

The aim was to derive 90<sup>th</sup> percentile values from the combined distributions of the available information on feed consumption and pesticide residue levels of the feed items. The input parameters used for these calculations are reported in sections 3.1 and 3.2, below.

### 3.1. Feed consumption

Data for consumption of nectar and pollen by adult bees and larvae are indicated in Table J1. The consumption data originate from EFSA Panel on Plant Protection Products and their Residues (PPR) (2012a), except where a footnote clarifies the origin. Only the most exposed type/caste of bees are considered here (e.g. drone honey bees eat less than foragers or nurse bees; therefore, a scenario for drones was not considered necessary).

As described above, the adult (forager) category of honey bees and bumble bees was further divided into acute and chronic subcategories. This separation was considered necessary because, in contrast to solitary bees, honey bees and bumble bees collect food that is stored for later consumption during the vegetation season (i.e. from early spring to autumn). When the foraging activity promises a valuable reward (e.g. there is a very good nectar flow), the foragers react with intensive foraging; hence their food consumption increases (cannot be described as ‘average’ consumption) (Balderrama et al., 1992). This is reflected in the higher SVs to be used for the acute assessments than for the chronic assessments. For the acute SVs, only the upper half of the consumption range was considered, while for the chronic SVs the full range was taken into consideration. As regards pollen consumption, the full range (where a range was available) was considered for the scenarios of weeds in the field and of the plants at the field margin, but only the highest (worst-case) values were considered for the scenarios of crop plants (i.e. the treated crop, adjacent crop and succeeding crop/permanent crop in the next year). This is because only limited information for the pollen consumption of bees was available. Moreover the data from Tasei and Aupinel (2008) indicated that the consumption of pollen is crop dependent (i.e. the protein content of pollens from different plants is different). It was noted that further research would be needed in this field.

**Table J1:** Data of nectar (sugar) and pollen consumption of bees and bee larvae

Organisms	Consumption of adult bees (mg/bee/day)		Consumption of larvae (mg/larva)	
	Sugar	Pollen	Sugar	Pollen
Honey bee	forager: 32–128 Nurse: 34–50	Forager: 0 Nurse: 6.5–12	59.4/5 days	1.5–2/5 days
Bumble bee	73–149	26.6–30.3	23.8/day	10.3–39.5 <sup>(3)</sup> /day
Solitary bee	18–77 <sup>(1)</sup>	10.2 <sup>(2)</sup>	54/30 days	387 <sup>(4)</sup> /30 days

<sup>(1)</sup>: This value was erroneously reported as nectar consumption in EFSA Panel on Plant Protection Products and their Residues (PPR) (2012a)

<sup>(2)</sup>: Estimated from bumble bee queen pollen consumption from (Prídál and Hofbauer, 1996), considering the difference in body weight (average body weight of young queen bumble bee 595.7 mg, body weight of solitary bee *Osmia cornuta* 131 mg, average pollen intake of queen bumble bee over six days 279.2 mg).

<sup>(3)</sup>: Based on all values from Tasei and Aupinel (2008) (in EFSA Panel on Plant Protection Products and their Residues (PPR) (2012a), only some these data were reported).

<sup>(4)</sup>: This value was erroneously reported in EFSA Panel on Plant Protection Products and their Residues (PPR) (2012a), but corrected here.

**Notes:**

Only upper half of the sugar consumption ranges of honey bee and bumble bee adults (are considered for the SVs for the acute assessments i.e. for honey bee 80–128 mg and for bumble bee 111–149 mg).

Only the highest values of the pollen consumptions (where a range is available) are considered for the SVs for the crop plant scenarios.

Since the energy demand of the bees or larvae is available (sugar consumption) rather than the nectar consumption, the sugar content of the nectar needs to be considered. The sugar content of nectar which maybe foraged by the bees was gathered from the scientific literature (Maccagnani et al., 2003); (Monzon et al., 2004);(Nicolson, 2009); however, it was noted by the Working Group that very little is known about the distribution and frequency of the sugar content carried by bees and it was identified that further research is needed in this field. It was considered by the Working Group that the worst-case values (i.e. nectar with the lowest sugar content from the ranges which maybe foraged by the bees), namely 15% for honey bees and bumble bees and 10% for solitary bees, are to be used for the

risk assessment, when they forage on a crop plants (i.e. the treated crop, adjacent crop and succeeding crop/permanent crop in the next year). For the weed and field margin scenarios, where bees may forage on a composition of different plants, the sugar content of 30% was used. This value is an average of 28 genera calculated by US-EPA<sup>27</sup>.

### 3.2. Residue levels

Measured residue levels in nectar and pollen of a certain number of pesticides are reported in Appendix F. The data were used for the calculations of SVs. It should be noted that SVs derived from data on spray applications are used also for solid applications for some scenarios (e.g. plants in the field margin) by using additional exposure correction factors (for further explanation please consult chapter 5 and Appendix X.). A default residue level of 1 mg/kg was considered for pre-emergence applications in the treated crop scenario (including the seed treatment) and for the weeds scenario (application before emergence of the weeds), as well as for the succeeding crop/permanent crop in the next year scenario. The residue levels are expressed as residue unit dose (RUD). RUD is the concentration in nectar or pollen (mg/kg) at an application rate of 1 kg/ha or 1 mg/seed. The latter is for treated crop for seed treatments.

The data from Appendix F., Table F1 (data for spray application), were divided into downwards and sideward/upwards spray applications and the lognormal distributions of the two datasets were calculated. Some data describing these distributions are reported in Table J2. For the dataset for pollen and downwards spraying, the three lowest RUD values were discarded from the related calculations. This was done because the remaining dataset gives a better description of the cumulative frequency of the upper part of the data distribution (this is visually presented in Figure F1 in Appendix F.) and the upper part of the distribution is an important part considering that the aim was to derive overall 90<sup>th</sup> percentile SVs. It is noted that only three RUD values were available for nectar and side/upwards spray applications. Although three values were considered as a weak basis for a lognormal distribution, the Working Group considered that this distribution should be used because this dataset systematically deviated from and was more conservative than the dataset for downwards spraying.

**Table J2:** Median and standard deviation of the distributions of RUD values used for the calculations

	Median (mg/kg)	Standard deviation of natural logarithms (-)
Nectar—side/upwards spraying	4.018	1.044
Nectar—downwards spraying	2.478	1.153
Pollen—side/upwards spraying	1.180	1.127
Pollen—downwards spraying	13.02	1.386

The downwards spraying dataset was used for weeds after emergence (after emergence of the weeds), adjacent crops and plants at the field margins. For the treated crop for spray application after emergence, either the distributions from the downwards spraying or from the side/upwards spraying were used depending on the spraying technology (e.g. for field crops: downwards spraying; for grapes, trees or hops: side/upwards spraying). For the treated crop for broadcasted granule formulations applied after emergence, the distributions from the downwards spraying were used (for the other cases, see explanation above).

### 3.3. Methodology of the calculations

Monte Carlo simulations were conducted for each category using the input parameters as described in sections 3.1 and 3.2, above. As described above, either the range of the sugar demand and the pollen

<sup>27</sup> US-EPA (2012) 'White Paper in Support of the Proposed Risk Assessment Process for Bees, September 2012'. The used data ordinates mainly from measurements performed by Butler (1944) and Wykes (1953).

consumption or a single value was used. Single values were used in cases where only a single value was available (therefore no distribution could be calculated) and for some scenarios for pollen consumption (for explanation see section 3.1, above). Where a range was used in the simulation, it was assumed that the data within the range are normally distributed. It was assumed that only 1% of the values were below or above the specified range. These distributions or single values were combined with the distributions of the RUD values (section 3.2, above) and with the fixed sugar content values as specified above in section 3.1. In the simulations for the treated crop for seed treatment and soil application (pre-emergence applications), for the scenario for succeeding crop/permanent crop in the next year and for weeds before emergence, the default residue level of 1 mg/kg was considered. The SV for the modelled category was defined as the spatial 90<sup>th</sup> percentile value (i.e. 90% hive) of the overall combined distributions after simulating the median consumption of at least 1000 hives (or individuals for solitary bees). The SVs refer to the residue intake of the organisms expressed in  $\mu\text{g}$  ( $\mu\text{g}/\text{bee}$  or  $\mu\text{g}/\text{larvae}$ ) provided that the application rate was 1 kg/ha or 1 mg/seed for the treated crop for seed treatments.

#### 4. Tables for shortcut values and some general considerations on the use of them

The SVs to be used in the screening step are listed in Table J3 and the SVs to be used in first tier risk assessments are included in Tables J4–J8, below. The values for the screening step are to be used for all crops and all crop stages. In the screening step it is assumed that the treated crop is attractive for both pollen and nectar. For the first tier assessments, the relevant tables to be used for a risk assessment are determined by the application method and the scenario to be considered. The title of the tables explain the scenarios (treated crop, adjacent crop, weeds in the field, plants at the field margin and succeeding crop/permanent crop in the next year) where the SVs of the table are relevant. Tables for crop plants (Tables J4–J6) contain three different sets of SVs for the three crop categories determined by the attractively (attractively to pollen and/or nectar). SVs to be used for the scenarios for weeds in the field and plants in the field margin are included in Table J7 and J8.

When the SVs are used, the followings need to be considered:

- The values express the residue intake of the organisms in  $\mu\text{g}$  ( $\mu\text{g}/\text{bee}$  or  $\mu\text{g}/\text{larvae}$ ) provided that the application rate is 1 kg/ha. However, the values for the treated crop for seed treatments the application rate of 1 mg/seed needs to be considered.
- The values for honey bee larvae refer to the intake over a five-day developmental period and the values for solitary bee larvae refer to a 30-day developmental period. All the other values (including the value for bumble bee larvae) were calculated using daily feed consumption; therefore, they refer to daily residue intake.
- It might be considered that there is no oral exposure via pollen and nectar or extrafloral nectar to bees from crops/plants when they do not produce these feed items or when they are not attractive to bees. In such cases the SV to be considered in the risk assessment will be 0  $\mu\text{g}$  instead of the relevant value from the tables below (meaning that practically no oral assessment is necessary for that scenario). However, when an SV of 0  $\mu\text{g}$  is used, the no exposure case of bees needs to be justified. For example, for the treated crop scenario it is justified if the active substance is used after the flowering period. It is also justified if the crop is not attractive to bees at all, like figs (as figs are permanent crops, the scenario for the next year should also consider a SV of 0  $\mu\text{g}$ ). The no exposure case It may be justified also if the active substance is used before the flowering period, but in this case several factors, e.g. the rate of degradation, potential for systemic transfer, formation of toxic metabolites or information on residue levels need to be considered. For weeds or plants at the field margin the no exposure case maybe justified if the application is made out of the foraging season of the bees (e.g. in winter), but the fate and behaviour of the active substance or the potential toxic metabolites needs to be considered (e.g. a similar assessment as for succeeding crop/permanent crop in the next year might be necessary).

- Different SVs are available for pre-emergence and post emergence situations for the treated crop scenario and for the weed scenario, but not for the other scenarios (i.e. it is considered that they are emerged or will be emerged)
- Both the forager and nurse are considered as adult honey bee. SVs for both forager and nurse honey bees were calculated for the category where exposure to nectar is possible. It is noted that the SVs for foragers are always higher than for nurse bees; therefore, at first tier level it is sufficient to consider only foragers for the risk assessment for adult honey bees. However, if compound specific RUD values are used in a higher tier risk assessment (i.e. 2<sup>nd</sup> tier assessment based on exposure refinement), the risk to nurse bees has to be assessed.
- For the risk assessment for HPG, the SVs calculated for the nurse should be used in the first tier level

**Table J3:** Shortcut values to be used in the **screening** steps. Values in brackets are referring to the treated crop scenario for seed treatment

Organisms	Downwards spraying or solid application		Side/upwards spraying	
	Adult	Larva	Adult	Larva
Honey bee	7.6 (0.7)	4.4 (0.4)	10.6	6.1
Bumble bee	11.2 (0.9)	4.5 (0.2)	13.3	2.6
Solitary bee	5.7 (0.49)	33.6 (0.93)	7.3	30.8

The screening step assessment for oral exposure is based on the worst case scenario, which is in most cases the treated crop except for Bumble bee and Solitary bee larvae for which the worst case is the risk from weeds in the treated field.

**Table J4:** The shortcut values (SVs) of this table are to be used for three situations/scenarios (for all the other situations/scenarios please check Tables J5-J8):

- 1) **treated crop** scenario for **downwards spraying** applied **after emergence**/from leaf development (i.e. BBCH  $\geq$  10)
- 2) **treated crop** scenario for **broadcasted granule** formulations applied **after emergence**
- 3) **adjacent crop** scenario (regardless of the formulation or the application method, thus for all situations; if the adjacent crops are not defined, consider that the crops are attractive for both the pollen and nectar)

Category	Input parameters					SV ( $\mu\text{g}$ )		
	Pollen consumption (mg/bee/day or mg/larvae)	Range or value for the sugar consumption (mg/bee/day or mg/larvae)	Sugar content of nectar (%)	Median $\pm$ SD of RUDs in pollen	Median $\pm$ SD of RUDs in nectar	Crop attractive for pollen and nectar	Crop attractive for pollen, only	Crop attractive for nectar, only
HB forager acute	–	80–128	15	–	2.478 $\pm$ 1.153	7.6	N/A*	7.6
HB forager chronic	–	32–128	15	–	2.478 $\pm$ 1.153	5.8		5.8
HB nurse	12	34–50	15	13.02 $\pm$ 1.386	2.478 $\pm$ 1.153	3.8	0.92	3.0
HB larva	2	59.4	15	13.02 $\pm$ 1.386	2.478 $\pm$ 1.153	4.4	0.15	4.3
BB adult acute	30.3	111–149	15	13.02 $\pm$ 1.386	2.478 $\pm$ 1.153	11.2	2.3	9.4
BB adult chronic	30.3	73–149	15	13.02 $\pm$ 1.386	2.478 $\pm$ 1.153	9.9		8.1
BB larva	39.5	23.8	15	13.02 $\pm$ 1.386	2.478 $\pm$ 1.153	4.5	3.0	1.7
SB adult	10.2	18–77	10	13.02 $\pm$ 1.386	2.478 $\pm$ 1.153	5.7	0.78	5.2
SB larva	387	54	10	13.02 $\pm$ 1.386	2.478 $\pm$ 1.153	33.6	29.9	5.8

\*: not applicable as the pollen consumption of forager HB is negligible. For a risk assessment for adult HB, the SV for nurse should be used.

**Table J5:** The shortcut values (SVs) of this table are to be used only for one situation/scenario (for all the other situations/scenarios please check Tables J4, J6, J7 and J8). This is the **treated crop** scenario for **side/upward spray** applications applied after emergence/**from leaf development** (i.e. BBCH  $\geq$  10)

Category	Input parameters					SV ( $\mu\text{g}$ )		
	Pollen consumption (mg/bee/day or mg/larvae)	Range or value for the sugar consumption (mg/bee/day or mg/larvae)	Sugar content of nectar (%)	Median $\pm$ SD of RUDs in pollen	Median $\pm$ SD of RUDs in nectar	Crop attractive for pollen and nectar	Crop attractive for pollen, only	Crop attractive for nectar, only
HB forager acute	–	80–128	15	–	4.018 $\pm$ 1.044	10.6	N/A*	10.6
HB forager chronic	–	32–128	15	–	4.018 $\pm$ 1.044	8.2		8.2
HB nurse	12	34–50	15	1.180 $\pm$ 1.127	4.018 $\pm$ 1.044	4.3	0.06	4.3
HB larva	2	59.4	15	1.180 $\pm$ 1.127	4.018 $\pm$ 1.044	6.1	0.01	6.1
BB adult acute	30.3	111–149	15	1.180 $\pm$ 1.127	4.018 $\pm$ 1.044	13.3	0.15	13.3
BB adult chronic	30.3	73–149	15	1.180 $\pm$ 1.127	4.018 $\pm$ 1.044	11.4		11.3
BB larva	39.5	23.8	15	1.180 $\pm$ 1.127	4.018 $\pm$ 1.044	2.5	0.20	2.4
SB adult	10.2	18–77	10	1.180 $\pm$ 1.127	4.018 $\pm$ 1.044	7.3	0.05	7.3
SB larva	387	54	10	1.180 $\pm$ 1.127	4.018 $\pm$ 1.044	9.6	1.9	8.3

\*: not applicable as the pollen consumption of forager HB is negligible. For a risk assessment for adult HB, the SV for nurse should be used.

**Table J6:** The shortcut values (SVs) of this table are to be used for four situations/scenarios (for all the other situations/scenarios please check Tables J4, J5, J7 and J8):

- 1) **treated crop** scenario for **spray** applications (both downwards and side/upward) applied **before emergence**/leaf development (i.e. BBCH < 10)
- 2) **treated crop** scenario for **seed treatment**
- 3) **treated crop** scenario for **granule formulations** applied **before emergence** (soil application)
- 4) **succeeding crop/permanent crop** in the next year scenario (regardless of the formulation or the application method, thus for all situations; if the succeeding crop/permanent crops are not defined, consider that the crops are attractive for both the pollen and nectar)

Category	Input parameters					SV (µg)		
	Pollen consumption (mg/bee/day or mg/larvae)	Range or value for the sugar consumption (mg/bee/day or mg/larvae)	Sugar content of nectar (%)	Default RUD in pollen	Default RUD in nectar	Crop attractive for pollen and nectar	Crop attractive for pollen, only	Crop attractive for nectar, only
HB forager acute	–	80–128	15	–	1	0.70	N/A*	0.70
HB forager chronic	–	32–128	15	–	1	0.54		0.54
HB nurse	12	34–50	15	1	1	0.29	0.012	0.28
HB larva	2	59.4	15	1	1	0.40	0.002	0.40
BB adult acute	30.3	111–149	15	1	1	0.90	0.03	0.87
BB adult chronic	30.3	73–149	15	1	1	0.78		0.75
BB larva	39.5	23.8	15	1	1	0.20	0.04	0.16
SB adult	10.2	18–77	10	1	1	0.49	0.01	0.48
SB larva	387	54	10	1	1	0.93	0.39	0.54

\*: not applicable as the pollen consumption of forager HB is negligible. For a risk assessment for adult HB, the SV for nurse should be used.

**Table J7:** The shortcut values (SVs) of this table are to be used for two situations/scenarios (for all the other situations/scenarios please check Tables J4, J5, J6 and J8):

- 1) scenario for **weeds** in the field when the weeds are **already emerged**; i.e. BBCH of the weeds  $\geq 10$  (regardless of the formulation or the application method)
- 2) scenario for **field margin** (regardless of the formulation or the application method, thus for all situations)

Category	Input parameters					SV( $\mu\text{g}$ )
	Range of pollen consumption(mg/bee/day or mg/larvae)	Range of sugar consumption(mg/bee/day or mg/larvae)	Sugar content of nectar (%)	Median $\pm$ SD of RUDs in pollen	Median $\pm$ SD of RUDs in nectar	
HB forager acute	–	80–128	30	–	2.478 $\pm$ 1.153	3.7
HB forager chronic	–	32–128	30	–	2.478 $\pm$ 1.153	2.9
HB nurse	6.5–12	34–50	30	13.02 $\pm$ 1.386	2.478 $\pm$ 1.153	2.1
HB larva	1.5–2	59.4	30	13.02 $\pm$ 1.386	2.478 $\pm$ 1.153	2.2
BB adult acute	26.6–30.3	111–149	30	13.02 $\pm$ 1.386	2.478 $\pm$ 1.153	6.5
BB adult chronic	26.6–30.3	73–149	30	13.02 $\pm$ 1.386	2.478 $\pm$ 1.153	5.9
BB larva	10.3–39.5	23.8	30	13.02 $\pm$ 1.386	2.478 $\pm$ 1.153	2.6
SB adult	10.2	18–77	30	13.02 $\pm$ 1.386	2.478 $\pm$ 1.153	2.3
SB larva	387	54	30	13.02 $\pm$ 1.386	2.478 $\pm$ 1.153	30.8

**Table J8:** The shortcut values (SVs) of this table are to be used only for one situation/scenario (for all the other situations/scenarios please check Tables J4 - J7). This is the scenario for **weeds** in the field when the weeds are **before emergence**; i.e. BBCH of the weeds < 10 (regardless of the formulation or the application method)

Category	Input parameters					SV(µg)
	Range of pollen consumption(mg/bee/day or mg/larvae)	Range of sugar consumption(mg/bee/day or mg/larvae)	Sugar content of nectar (%)	Default RUD in pollen	Default RUD in nectar	
HB forager acute	–	80–128	30	–	1	0.35
HB forager chronic	–	32–128	30	–	1	0.27
HB nurse	6.5–12	34–50	30	1	1	0.15
HB larva	1.5–2	59.4	30	1	1	0.20
BB adult acute	26.6–30.3	111–149	30	1	1	0.46
BB adult chronic	26.6–30.3	73–149	30	1	1	0.40
BB larva	10.3–39.5	23.8	30	1	1	0.11
SB adult	10.2	18–77	30	1	1	0.17
SB larva	387	54	30	1	1	0.57

## Appendix K. LITERATURE REVIEW ON DAILY MORTALITY RATE

### FORAGER HONEY BEES

**Visscher and Dukas (1997)** investigated the lifetime foraging duration and survivorship of individual honey bees (*Apis mellifera* L.) foraging in a natural setting.

In the experiment, bees were allowed to emerge in an incubator. Bees were individually marked with numbered tags and introduced into a two-frame observation hive containing about 3000 bees. In total, three introductions of 40 bees, each three days apart, were made. Two weeks after introducing the first bees into the hive, the few marked bees that had already begun foraging were removed, and the observations started. The nearest bee colonies were about 100 metres away in the opposite direction from the flight line of their colony, and there were many nearby distinctive landmarks, so that drifting of foraging bees from their colony was minimised. A 50-cm transparent tunnel provided the bees with access to the outdoors. A portion at the centre of the tunnel could be gated at each side and removed. In this removable cage, each marked bee was individually trapped each time it either departed on or returned from a foraging trip. The bee was weighed on a balance which reported bee weight with precision of  $\pm 0.1$  mg, directly to a personal computer, which averaged a total of at least five readings. The computer recorded the time of day, and information about the bee's identification number and its direction was added, either exiting or returning to the hive. From these records, trip time was later calculated, along with net weight of nectar uptake, and net rate of nectar uptake (mg/min) for each foraging trip by each bee. The analysis includes 33 bees for which a complete lifetime record was available from the first foraging trip until the bee did not return; all 33 of these bees foraged exclusively for nectar.

**The mean lifespan of foraging bees was of 7.7 days  $\pm$  0.75 (SE) days, the median 7 days and range 2–17 days. Thus, the daily mortality was about 13 %.**

Schippers et al. (2006) assessed honey bee foraging performance.

The research was carried out in southern Ontario, Canada, from early June to early July 2004. The average ( $\pm$  SEM) daily high temperature was  $23.2 \pm 0.65$  °C. Forage during this period was abundant. The empty honeycomb placed in the observation hive at the start of the experiment was 100 % full 29 days later. Assuming a full frame mass of 4.5 kg, this corresponds to an average daily increase in frame mass of 155 g. Newly eclosed bees (*Apis mellifera* L.) were marked with individually numbered tags and introduced into a two-frame observation hive containing approximately 2 000 bees. Four introductions of 80 bees three days apart were made in order to have bees commencing foraging over several days. Two weeks after introducing the first bee cohort, a few bees that had already initiated foraging were removed and data recording began. All bees departing and entering the hive travelled through a transparent Plexiglas tunnel. These bees were collected at four different life stages: hive bees (11–15 days old), young foragers (2 days of foraging experience), mature foragers (4–11 days of foraging experience) and old foragers (12 days of foraging experience).

**The average foraging lifespan of the 27 bees (out of 38) that died before the end of the experiment was  $9.7 \pm 0.9$  days, and the median foraging span was 8 days. This means a daily mortality rate of 10.3 %.**

Rueppell et al. (2007) assessed the importance of extrinsic risk on worker mortality, how foraging is quantitatively related to mortality, how variation in life history between two selected strains correlates with mortality and how chronological age affects mortality.

Focal cohorts of honey bees (*Apis mellifera* L.) in colonies of a natural age composition were studied. Honey bee queens in the source colonies were induced to lay eggs in empty combs. These combs were brought into a humidity- and temperature-controlled incubator (33 °C/60% relative humidity) one day

prior to emergence of the focal cohort bees. Within 12 hours of emergence, worker bees were marked with individually numbered coloured tags and introduced into an unrelated host colony. The host colonies were maintained in four-frame observation hives in a dark, temperature-controlled room with immediate access to the outside (either flight cage or natural habitat).

During the experiments, resource and brood levels were kept equal in the different experimental groups by exchanging selected frames and additional feeding if necessary. The entrance of each hive was observed for incoming, tagged bees during the peak of foraging activity.

In the first experiment, the life histories of workers that were free-flying was compared with those workers that were confined to foraging in a flight cage in which food (30 % sucrose solution and ground, dried pollen) was offered from 10:00 am to 12:00 am daily.

Two simultaneous replicates of the following paired design were used. Two equal colony halves were established (ca. 4000 workers each) from a source colony, stocked with a queen, and introduced into a four-frame observation hive. The two observation hives were connected at the back through a mesh-wire screen to permit food exchange between colony halves. The hive entrance of one hive opened into the natural foraging environment, and of the other hive led into a semicircular flight cage (11 m long, 6.5 m wide, 3.3 m high, 60% shade cloth) with one sucrose and one pollen feeder located five metres from the hive entrance.

At the beginning of the experiment 960 newly emerged, individually tagged workers were introduced into each colony half. Daily foraging observations and nightly survival censuses began the following day. Bees that died during the first five days were excluded from the analyses because the handling and marking can artificially increase mortality. Foraging activity of both colony halves was observed for 30 min each during the feeding period. All incoming bees were recorded to obtain an estimate of total foraging activity along with specific foraging data on the tagged bees to verify the experimental treatment.

**Table K1:** Results of the first experiment

	Free-flying		Caged (2h)	
	Col1	Col3	Col2	Col4
Foragers ( <i>n</i> )	288	335	183	175
Forager lifespan (days)	26.3 (25.6–27.0)	25.6 (24.8–26.3)	30.7 (29.6–31.9)	32.9 (31.7–34.1)
Mortality rate (1/lifespan × 100)	3.80%	3.91%	3.26%	3.04%
Flight span (days)	3.3(2.9–3.8)	4.9 (4.4–5.4)	5.3 (4.4–6.1)	4.7 (3.9–5.5)
Daily mortality rate (1/flight span × 100)	30.3%	20.4%	18.9%	21.3%

In the second experiment, the quantitative effect of foraging into flight cages was assessed. Worker mortality was compared between cohorts that had access to pollen and nectar sources in the flight cages either *ad libitum* or for only one hour per day. Each cohort was introduced into a separate host colony, controlled for levels of brood and food. In the *ad libitum* treatment, three pollen and three nectar feeders were available throughout the day. The other group of bees only had access to one pollen and one nectar feeder from 10:00 am to 11:00 am. During feeding, foraging activity was not significantly lower in the limited colony than in the unlimited colony but it was significantly reduced when no food was available.

A focal cohort of 480 workers was introduced into both colonies. In contrast to the first experiment, these were initially installed in small hive boxes and transferred to the four-frame observation hives

only at the onset of the observations (five days after the introduction of the focal bees). Overall foraging activity was assessed during six-minute entrance scans, but individual foraging data were collected by directly observing the feeders (between 20 and 40 minutes daily).

Individual survival was additionally monitored by nightly censuses, as in the first experiment.

**Table K2:** Results of the second experiment

	<b>Caged (24 hours food)</b>	<b>Caged (1 hour's food)</b>
Foragers ( <i>n</i> )	113	60
Forager lifespan (days)	20.4 (19.6–21.2)	21.0 (20.1–21.9)
Mortality rate (1/lifespan × 100)	4.90%	4.76%
Flight span (days)	7.3 (6.2–8.4)	11.3 (9.2–13.5)
Daily mortality rate (1/flight span × 100)	13.7% %	8.85%

The third experiment compared the mortality between the workers from the bidirectionally selected high and low pollen-hoarding strains. One host colony received 350 high and 530 low pollen-hoarding bees; the second host colony received 250 of each as focal cohorts. As in the second experiment, the colonies were transferred to observation hives five days after the introduction of the focal cohorts, just before the beginning of the observations. Both colonies foraged into the natural environment but their resource and brood levels were maintain at comparable levels.

**Table K3:** Results of third experiment

	<b>Low pollen</b>		<b>High pollen</b>	
	<b>North</b>	<b>South</b>	<b>North</b>	<b>South</b>
Foragers ( <i>n</i> )	131	246	165	168
Forager lifespan (days)	26.7 (25.9–27.1)	26.5 (25.9–27.1)	23.4 (22.6–24.1)	23.2 (22.3–24.1)
Mortality rate (1/lifespan × 100)	3.74%	3.77%	4.27%	4.31%
Flight span (days)	3.6 (3.0–4.1)	3.6 (3.0–4.1)	3.3 (2.8–3.7)	6.1 (5.3–6.7)
Daily mortality rate (1/flight span × 100)	27.8%	27.8%	30.3%	16.4%

Dukas (2008) tested the effects of senescence on honey bees foraging in natural settings and documented the predicted pattern of exponential increase immortality rate with forager age. Those data indicated that, in spite of high rates of external mortality, senescence was an important factor determining the performance of insects such as honey bees in the wild.

The main experiment involved a two-frame observation hive containing about 2500 bees. A second similar observation hive was used primarily for another study, but the marked bees in that hive were also monitored and are included in the dataset. Dukas made three introductions of newly eclosed honey bees with individually numbered plastic tags each about 10 days apart. The first hive received 250 marked bees at each introduction and the second hive received 100, 50 and 100 bees in the first, second and third introductions respectively. The successive introductions resulted in bees commencing foraging over a long period of time. This made monitoring of the bees easier and also decoupled effects of age and day effects owing to variation in hive conditions, weather and other external factors such as predator activity and competitors. Overall, bees initiated foraging at an average age of  $12.8 \pm$

0.28 days, and foragers from the two hives had nearly identical mean lifespans ( $6.6 \pm 0.3$  and  $6.8 \pm 0.2$ ).

The observation hives were placed inside a research trailer and connected to the outdoors through transparent Plexiglas tunnels.

Out of the total of 852 marked bees observed throughout the study, 611 bees were recorded as foragers. Only these 611 bees were included in the analysis.

The results indicated an exponential increase in mortality rate with age in forager honey bees under natural settings. This was in spite of the relatively high value ( $\sim 13.4\%$ ) of the age-independent mortality rate. It was likely that both the age-independent and age-dependent mortality rates were caused primarily by predation, with the age-dependent factor increasing exponentially owing to physiological and mechanical deterioration.

Rueppell et al. (2009) set up an experiment to compare individual worker life histories and lifespan between two differently sized colonies as social environment. Large cohorts of individually marked worker honey bees were used and monitored their foraging activity in addition to survival because the transition from in-hive duties to foraging is a major determinant of honey bee worker lifespan.

Two pairs (experimental trials) of one small and one large hive were made up from, respectively, one and two pounds (one pound approximates to 4500 individuals) of worker bees. The bees were shaken from a mixture of European source hives and then randomly divided into the experimental treatment groups. These groups were then installed in five-frame nucleus hives with queens that had mated naturally. One week later, 12 frames of brood comb with ready-to-emerge worker brood were collected from the same European source hives kept in the experimental apiary. Bees emerged overnight in a temperature- ( $34^\circ\text{C}$ ) and humidity- ( $50\%$ ) controlled incubator. Bees were individually marked by gluing numbered plastic tags on their dorsal thorax and 796 were introduced into each observation hive. Just prior to that, 400 and 800 untagged new workers were introduced to the small and large hive, respectively, to facilitate the introduction process for the tagged, focal individuals. One day later, colonies were transferred into glass-walled observation hives that each contained one frame of honey, one fully drawn, empty frame and two frames of foundation. One day after this transfer, daily survival and foraging observations began.

Worker survival was monitored daily after sunset by systematically recording all marked individuals present in the colony. Since worker bees return daily to their hive as long as they are alive, death was inferred to have occurred one day after the last recording of a bee.

All bees returning from foraging trips were recorded daily for two hours during the peak of foraging activity to determine the age of foraging initiation. Workers returning with pollen on their legs were classified as pollen foragers; all others were classified non-pollen foragers. From the foraging records, the number of foraging days was calculated and the pollen foraging bias as the proportion of foraging observations for each worker that included pollen collection.

**Table K4:** Worker lifespan and flight span

	Worker lifespan (days)	Flight span (days)	Daily mortality rate (1/flight span * 100) (%)
Large hive 1	$22.8 \pm 9.4$ (22.1–23.5), $n=671$	$7.5 \pm 6.6$	13.3
Large hive 2	$22.3 \pm 7.6$ (21.7–22.9), $n=609$	$6.5 \pm 5.3$	15.4
Small hive 1	$26.6 \pm 8.9$ (26–27.3),	$6.7 \pm 6.0$	14.9

	<i>n</i> =680		
Small hive 2	26.4±9.7 (25.6–27.1), <i>n</i> =709	8.8±6.9	11.4

Khoury et al., (2011) developed a quantitative model of honey bee colony population dynamics. As input parameters, the values for lifespan reported by Rueppel et al. (2009) were used.

### WORKER ADULT HONEY BEES

Sakagami and Fukuda (1968) gave tables for workers honey bees throughout their all developmental stages. Their results showed an average longevity for June adult bees of 28.345 days (mortality rate 3.53%), an average longevity for July adult bees of 32.424 days (mortality rate 3.08%), an average longevity for wintering adult bees of 154.095 days (mortality rate 0.65 %) and an average longevity for postwintering adult bees of 23.431 days (mortality rate 4.27%).

Schmidhempel and Wolf (1988) randomly selected workers of a single colony and forced them to restrict their foraging activities to different degrees while living in the natural context of their hive to maintain homogeneity among the tested workers with regards to colony, external conditions and heritable components. The relationship between lifespan and work loads given under field conditions was studied.

One comb containing sealed cells ready for eclosion, together with nurse bees, was removed from the hive and put in an incubator at 35°C. From this comb, freshly hatched bees were collected several times a day, individually marked and reintroduced to the colony. This procedure was repeated until 280 bees had been marked.

The emerging bees were randomly assigned to one of the five treatment groups which differed in the amount of the individuals were allowed to forage outside the hive. An observer was placed at the entrance of the hive for eight hours each day during the main foraging activity period. Within the 8h treatment period, the individuals could forage for zero, two, four, six and eight hours (H0, H2, H4, H6, H8). Individuals of the H8 were always allowed to forage and thus served as control where the individuals of H0 could never leave the hive.

**Table K5:** Lifespan for forager bees in the five treatments.

	H0	H2	H4	H6	H8 (control)
Sample size	49	59	57	46	49
Lifespan (days)	41.6	41.3	41.9	45.1	39
Mortality rate% [(1/lifespan) × 100]	2.40	2.42	2.39	2.22	2.56

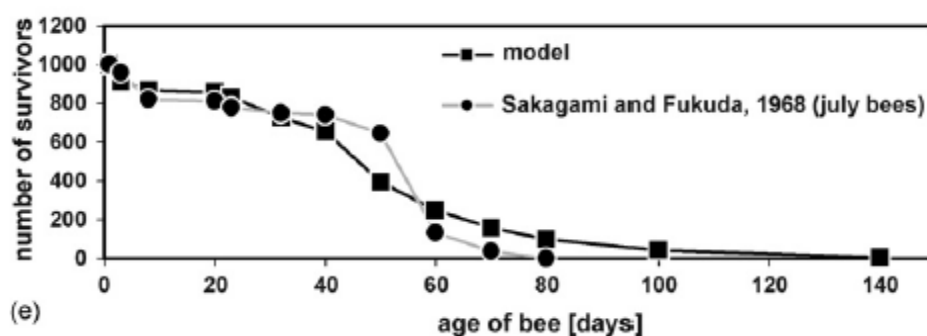
Schmickl and Crailsheim (2007) used the following values as mortality rate for their model:

For adult bees:           Base mortality = 1%;  
                                   Nursing mortality = 0.5%;  
                                   Processing mortality = 0.5%;  
                                   Foraging mortality = 3.5%;

For immature stages:   Eggs = 3%;  
                                   Larvae = 1%;  
                                   Pupae = 0.1%

They created a simple mathematical model for honey bee population model, using difference equations to model the population dynamics and the resource dynamics of a honey bee colony. They

generated a simulated life-table based on the mortality rates they used in their model and compared the resulting survivorship with the one reported by Sakagami and Fukuda (1968).



**Figure K1:** Comparison of life-table given by Sakagami and Fukuda and the model's simulated life table

**Table K6:** Overview on daily honey bee forager mortality rates

Study	Flight span	Daily mortality rate
Visscher and Dukas (1997)	7.7	12.99
Schippers et al (2006)	9.7	10.31
Rueppel (2007) (median values)	4.8	20.83
Dukas (2008)	7.5	13.33
Rueppel et al. (2009) (median values)	7.1	14.1
Sakagami and Fukuda (1968)* average of June and July bees (lifespans 8.345, 12.424)	10.4	9.63
Schmid-Hempel and Wolf* (1988) (only control group)	19	5.26
Min	4.8	5.26
Max	19	20.83
MEDIAN	7.5	13
10th percentile	5.72	7.88

\*The total adult lifespan was reported. It was assumed that adult bees will be 20 days in-hive before they start foraging. The forager flight span was calculated from the total lifespan minus 20 days.

## BUMBLE BEES

Schmidhempel and Heeb (1991) reported an average mortality rate for *Bombus lucorum* worker bees in the control colonies of 31.1% per week. This gives a daily mortality rate of 4.4%.

da Silva-Matos and Garofalo (2000) aimed at examining **adult worker longevity** in queenright (QR) and queenless (QL) colonies of *B. atratus* in order to verify if this bionomic character differs between the two types of colonies. Queenright colonies produced 1605 (QRC-1) and 639 (QRC-2) workers while in queenless colonies the number of workers produced was 798 in QLC-1 and 1119 in QCL-2. No distinction between house bees and foragers was made in either colony because all workers, except the egg-laying ones, were observed to forage, although some of them began foraging early than others. The mean longevity for the workers from QLC was not significantly different from that of workers

from QRC. The daily mortality rate was QLC-1=4.50%; QLC-2=4.95%; QRC-1=4.11%; QRC-2=5.68%.

Gill et al. (2012) mimicked a realistic scenario in which 40 early-stage bumble bee (*B.t. terrestris*) colonies were long-term (four weeks) exposed to imidacloprid or  $\lambda$ -cyhalothrin when foraging on flowering crops. By means of a split block design, colonies exposed to each pesticide independently and in combination were monitored (10 as control, 10 exposed to imidacloprid (I), 10 to  $\lambda$ -cyhalothrin (LC) and 10 exposed to a mixture of the two pesticides (M)). Imidacloprid was provided at a concentration within the range found in crop nectar and pollen in field (10 ppb);  $\lambda$ -cyhalothrin was administered following label indication for spray application. Individual forager behaviour was recorded using radiofrequency identification (RFID) tagging technology. Colonies were provided with no pollen and limited amounts of sucrose solution. During the experiment, 223 (21% of the total) workers were found dead inside nest boxes. On average,  $36 \pm 7.3\%$  and  $39 \pm 7.5\%$  of workers from LC and M colonies, respectively, died in the nest box, while for the control the mortality was four times lower,  $9 \pm 3.4\%$ .

The RFID showed that the number of foragers per colony is significantly correlated with the number of workers leaving the colony and getting lost outside and then, workers that did not return. It was found that, on average, the percentage of foragers getting lost in I and M colonies was 50% and 55% higher than control colonies ( $I=30 \pm 3.1\%$ ,  $M=31 \pm 3.3\%$  versus control  $20 \pm 2.9\%$ ). Furthermore, when considering worker mortality and losses combined over the four weeks (mean ( $\pm$  SEM)  $I=41 \pm 4.2\%$ ,  $LC=51 \pm 6.8\%$ ,  $M=69 \pm 7.1\%$  versus control  $=30 \pm 5\%$ ) it was found that colonies treated with both pesticides suffered most severely.

Considering the 30% control mortality over a period of four weeks, this gives a daily mortality of 1.07%.

Stelzer et al. (2010) performed several transplant experiments comparing the loss rate of workers from native and non-native populations in order to test whether it is true that the predators learn to avoid bumble bee workers with local, familiar coloration. The authors carried out three blocks of observation consecutively in Sardinia and Germany in 2001. Each block consisted of one colony from each of the three populations: *B.t. sassaricus*, *B.t. terrestris* and *B.t. canariensis*. All three colonies were placed simultaneously in the field within five metres of each other. The results showed significant differences in loss rate among *B. terrestris* populations. In Sardinia, the native populations suffered the highest mean loss rate, which was more than twice that of *B.t. terrestris* and three times that of *B.t. canariensis* at that location. In Germany, *B.t. sassaricus* again suffered the highest mean loss rate, followed by the native population *B.t. terrestris* and *B.t. canariensis* (see Table K6).

**Table K7:** Overview of the data collected by the authors during the transplant experiment

	Population	Foragers	Lost foragers	% daily
<b>Sardinia 2001</b>				
Block A	<i>B. sassaricus</i>	50	21	42.00
	<i>B. terrestris</i>	40	20	50.00
	<i>B. canariensis</i>	58	18	31.03
Block B	<i>B. sassaricus</i>	40	7	17.50
	<i>B. terrestris</i>	60	28	46.67
	<i>B. canariensis</i>	52	9	17.31
Block C	<i>B. sassaricus</i>	33	2	6.06
	<i>B. terrestris</i>	42	5	11.90
	<i>B. canariensis</i>	33	2	6.06
<b>Germany 2001</b>				
Block A	<i>B. sassaricus</i>	18	6	33.33

Block B	<i>B. terrestris</i>	38	10	26.32
	<i>B. canariensis</i>	37	5	13.51
	<i>B. sassaricus</i>	28	2	7.14
Block C	<i>B. terrestris</i>	16	1	6.25
	<i>B. canariensis</i>	42	2	4.76
	<i>B. sassaricus</i>	37	5	13.51
UK 2004	<i>B. terrestris</i>	16	1	6.25
	<i>B. canariensis</i>	11	0	0.00
	<i>B. canariensis</i>	19	3	15.79
UK 2005	<i>B. dalmatinus</i>	23	4	17.39
	<i>B. canariensis</i>	70	29	41.43
	<i>B. dalmatinus</i>	31	4	12.90

*B.t. sassaricus* (Sardinia and Germany, 2001): median = 13.51; min = 6.06; max = 42 and 10th percentile = 6.708.

*B.t. terrestris* (Sardinia and Germany, 2001): median = 11.90; min = 6.25; max = 50 and 10th percentile = 7.74.

*B.t. canariensis* (Sardinia and Germany, 2001): median = 13.51; min = 0; max = 31.03 and 10th percentile = 2.856.

### Conclusion on the bumble bee mortality rates

*B. atratus* is a neotropical species and it is uncertain if the mortality rates are representative for European species. Much lower daily mortality rates of bumble bees than in the other studies were observed in the study of Gill et al. (2012). In this study bees were fed sucrose solution in the laboratory and hence were not forced to forage for nectar. The bumble bees foraged only for pollen. It is likely that the foragers did not spend so many hours outside the nest as if they would have when they were forced also to collect nectar. Foraging flights are risky and hence less foraging flight time means that the mortality rates are lower. Lifespan of a bee is also correlated to the total hours of flying. If a bee forages very intensively then the lifespan will be shorter which leads to higher mortality rates. Therefore, it was decided not to include the results on background mortality in controls from the study of Gill et al. (2012) in the analysis of natural background mortality. The lowest value for background mortality from the study of Schmid-Hempel and Heeb (1991) of 4.4 % was used to derive the trigger values.

## Appendix L. USE OF HQ AND ETR APPROACH FOR SOLID FORMULATIONS

EFSA Panel on Plant Protection Products and their Residues (PPR) (2012a) proposes that it is possible to use the HQ approach, along with the associated trigger value, as part of the seed treatment/granule, or solid formulation scheme. In particular, EFSA Panel on Plant Protection Products and their Residues (PPR) (2012a) proposes using it in the assessment of risk from dust drift.

The original concept behind the HQ and ETR approach and the associated trigger value was developed for spray applications. To read across to solid formulations, there needs to be an assessment of whether a solid formulation poses an equivalent (or lower) risk to sprays. In order to do this, there should be a consideration of the toxicity of a spray formulation versus the toxicity of dust from a solid formulation, as well as a consideration of exposure

As regards toxicity, it is likely that in terms of toxicity, that when expressed in equivalent terms (i.e.  $\mu\text{g a.s./bee}$ ), a spray formulation is *potentially* more toxic than the active substance and that a solid formulation is probably of similar toxicity to the active substance.

Exposure from spray formulations will mainly consist of oral and contact. Exposure via the oral route may occur when the bees consume contaminated pollen or nectar, water, guttation fluid which has either been contaminated directly by spray deposit or via systemic action of the active substance. As regards contact exposure, this is possible if the bee is sprayed directly or comes in to contact with spray deposits. It should be noted that, when a bee cleans itself, it may then consume what is deposited on it.

As for exposure from dust from solid formulations, it is considered that the routes will be similar as for sprays above. In addition, it is feasible that if dust is present in or on the flower then a bee may come in to contact with this when working flowers. This may then be taken up orally when the bee cleans or is cleaned by others in the hive; it is feasible that this route could be more important than the similar route for spray applications.

According to the above, the toxicity of the formulation of a solid formulation is likely to be less than that for a spray formulation, as regards exposure, this is likely to be similar, although there is a possibility that exposure may be greater than with the spray from deposition of the dust in flowers. Taking all this together, it is feasible that using a HQ or ETR approach may be appropriate and hence would mean the same as for a spray treatment.

The HQ is calculated with the in-field dose. Soil treatments and sowing of seeds are usually performed on bare soil, which means that bees are not expected to be exposed in the field. The off-field dose will always be (much) lower than the in-field dose. This means that the calculated HQ is much higher than the HQ relevant for the off-field.

## Appendix M. TRIGGER VALUES

### Risk quotients and first tier trigger values

The toxicity exposure ratio (TER) is a risk quotient that is calculated for each particular combination of a non-target organism and a PPP. Conventionally, the quotient is calculated as the ratio of the intake of the PPP that is lethal to half the subjects exposed, or the LD<sub>50</sub>, and the level of environmental exposure, denoted *E*. Here we generalise the principle to any response variable, lethal or sublethal. Therefore, the dose required to reduce performance on any variable, including survivorship, is denoted by *D*<sub>50</sub>. Thus, the TER is given by:

$$\text{TER} = D_{50}/E \quad (\text{M1})$$

Higher tier testing is invoked when the TER is less than the trigger criterion, *T*, i.e.

$$D_{50}/E < T \quad (\text{M2})$$

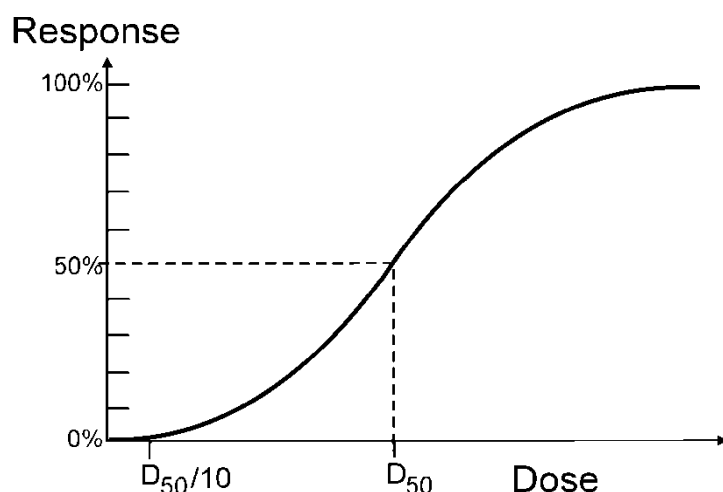
Algebraic rearrangement of Eqn O2 shows that Higher Tier testing is invoked when the environmental exposure exceeds 100/*T*% of the *D*<sub>50</sub>:

$$E > D_{50}/T \quad (\text{M3})$$

For lethal effects, the trigger criterion typically has been set at ten, so that Higher Tier testing is invoked when the environmental exposure exceeds 10% of the LD<sub>50</sub>:

$$E > D_{50}/10 \quad (\text{M4})$$

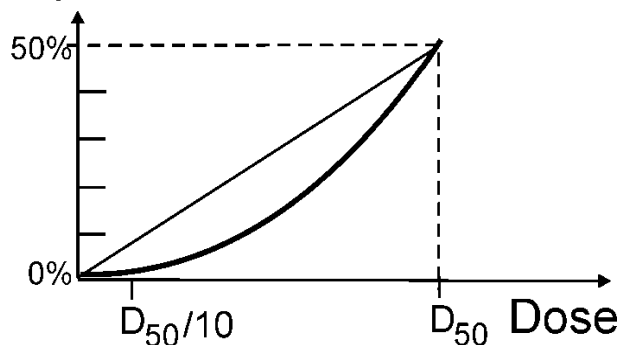
It is necessary to establish the maximum level of potential threat that can be expected from a PPP that has been eliminated from further consideration by first tier testing. Specifically, we must establish the effect of a PPP that has just exceeded the trigger value by having a level of environmental exposure of  $E = D_{50}/T$ . The degree of detrimental effect due to a dose of  $D_{50}/T$  depends on the dose–response relationship, which is typically a sigmoidal function (Figure M1).



**Figure M1:** A typical dose–response relationship, where ‘Dose’ (*x*-axis) indicates the environmental exposure of an individual organism and ‘Response’ (*y*-axis) indicates the percentage of individuals that exhibit the response being measured. *D*<sub>50</sub> denotes the dose at which 50 % of individuals respond and for the case where the trigger criterion *T* = 10, *D*<sub>50</sub>/10 denotes one tenth of this exposure

Provided that the dose–response relationship is sigmoidal and that its gradient accelerates at the lowest doses, the maximum response to a particular dose is given by a linear relationship,  $\text{response} = \text{dose} \times 50/D_{50}$  (Figure M2).

## Response



**Figure M2:** The lower left quadrant of the dose–response relationship from Figure M1. If the dose–response relationship is sigmoidal, its gradient must accelerate in this quadrant, which implies that the maximum response to  $D_{50}/10$  is given by a linear relationship,  $\text{response} = \text{dose} \times 50/D_{50}$ . The slope of this relationship is obtained because starting from the origin there is a rise of 50 % in response across a run of  $D_{50}$  and the slope of a linear relationship is given by rise over run

Given that  $\text{response} = \text{dose} \times 50/D_{50}$ , the maximum response to an exposure, or dose, of  $D_{50}/T$  is obtained by  $D_{50}/T \times 50/D_{50}$ , or  $(50/T)\%$ . For the case where the trigger criterion  $T = 10$ , we obtain a maximum response of  $(50/10)\%$ , or 5%.

## Notes

To defend this conclusion, the following must be further justified by evidence: that dose–response relationships for PPPs are linear or sigmoidal. Gathering this evidence is a target for further research.

Note that the dose–response relationships presented here are generic and not necessarily based on mortality. It is an open question whether an exposure of  $D_{50}/10$  based on mortality testing will safeguard sublethal responses to a level below 5%. Other endpoints may be more sensitive than mortality and so resolving this question requires further research.

There is always statistical uncertainty associated with working from dose–response relationships fitted to experimental data. Our guidelines will need to make reference to necessary levels of statistical power etc. in this context.

**Table M1:** Overview on combinations of magnitude of effects on forager mortality and time to reach point of where the colony may collapse (< 5000 bees in the hive) (for details see [Appendix A](#)):

Multiple of background mortality of forager bees (0.153 was used in the model)	Negligible effect (reduction in colony size of $\leq 7\%$ )	Small effect (reduction in colony size of $\leq 15\%$ )	Medium effect (reduction in colony size of $\leq 35\%$ )	Viable after 50 days?
$\times 1.5$ ( $m = 0.231$ )	6 days	13 days	40 days	Yes
$\times 2$ ( $m = 0.308$ )	3 days	7 days	18 days	Yes
$\times 3$ ( $m = 0.462$ )	2 days	4 days	10 days	No

## Notes

The protection goal is defined as a reduction of colony size of < 7%. The Khoury model (Khoury et al., 2011) was used to translate this effect on colony size into increase in forager mortality compared with background levels. The forager mortality which could be tolerated would be an increase in background mortality by a factor of 3 over two days, a factor of 2 over three days or a factor of 1.5 over six days. In addition, a factor of 1.27 was calculated for the increase of background forager mortality over 10 days.

The background mortality which was used in the modelling of Khoury et al. is 15.3% ( $m = 0.153$ ). This background mortality was not used to derive the trigger values. Instead, the relative increase in mortality (= factor of increase of background mortality) was used to derive trigger values as outlined below (this factor of increase in background mortality is also called increment ( $I$ )). Hence the actual trigger values are independent of the background mortality which was chosen for the Khoury model.

For deriving the trigger values the increase of mortality over 2 days and 10 days are relevant as this is the duration over which the mortality is observed in the acute and the chronic tests with adult bees.

The mortality in the laboratory studies is already corrected for background mortality observed in the controls. Therefore, the mortality observed in the treatments does not include the background mortality. Hence it is necessary to reduce the factor of increase in mortality by 1 to derive the acceptable mortality. Please see the example below, in which the acceptable mortality (= maximum increment above background level) is calculated as follows for the acute toxicity over two days (standard acute toxicity tests which last two days):

### Example:

The acceptable mortality (maximum increment above background level) is  $max. increment = (I - 1) \times m_E$

**Test** = acute mortality over two days

**Protection goal** = increase of mortality by a factor of 3 over two days (as the LD<sub>50</sub> is a 48-hour study), increment ( $I$ ) = 3

**Background mortality** (=  $m_E$ ) = 5.3 %

**Acceptable mortality** (=  $max. increment$ ) =  $(I - 1) \times m_E = (3 - 1) \times 5.3\% = 10.6\%$

### Determining a trigger value for an oral 10-day exposure.

*Overview:* This procedure finds the maximum dietary exposure of a compound that causes a level of mortality over 10 days that would impose no more than a negligible impact on a honey bee colony, as required by the SPGs. The required proportional elevation in mortality is determined from the Khoury model (Khoury et al., 2011) and assuming the standard parameterisation of Henry et al. (2012b), which is conservative in assuming that the colony has a relatively low capacity to replenish lost foragers (Cresswell and Thompson, 2012) and this is then applied to a more conservative estimate of the background rate of mortality under field conditions. The exposure required to cause this elevation is determined from a laboratory dose–response relationship.

1. Find the daily mortality rate in the Khoury model that causes a 7% decrease in colony size over 10 days (see the magnitude of a 'negligible effect' in the SPGs). Denote this rate by  $m_{7,10}$ .
2. Find ratio of  $m_{7,10}$  to the 'background' rate of daily mortality assumed in the Khoury model\* (i.e. 0.154). The maximum relative increase in daily mortality rate that meets the SPG is  $I = m_{7,10}/0.154$ .
3. Assume that the environmentally relevant background rate of daily mortality under field conditions is  $m_E$ . Therefore, the maximum rate of mortality that meets the SPGs for the relevant environment is  $I \times m_E$ . The maximum increment above background level is therefore  $max. increment = (I - 1) \times m_E$ .
4. For the compound in question, consider the dose-response relationship between oral dietary exposure dosage and mortality rate and determine the compound's  $LC_{50}$ , where  $LC_{50}$  denotes the exposure dosage necessary to produce 50% mortality after 10 days.

Assuming that the dose-response relationship is linear through the origin (i.e. zero dose-dependent mortality in the control dose) in the dosage range zero to  $LC_{50}$  (see justification in Appendix A. ), the maximum dietary exposure that meets the protection goal is given by  $max. increment \times LC_{50}/50$ , which is explained as follows.

Let  $X$  denote the exposure that causes the maximum mortality permitted under the SPGs. Assume that the dose-response relationship is a straight line defined by  $mortality = exposure * 50/LC_{50}$ . (This assumption is conservative because it produces higher mortality at low doses than an accelerating sigmoidal curve.) Note that this dose-response relationship passes through the origin (zero dose-dependent mortality above background at zero dose) and that  $mortality = 50\%$  at  $exposure = LC_{50}$  as required.

The point  $(max. increment, X)$  lies on the dose-response relationship with coordinates  $mortality = max. increment, exposure = X$ , so we can find  $X$  given  $max. increment$ . When  $mortality = max. increment$  and  $exposure = X$ , we use  $mortality = exposure * 50/LC_{50}$  to obtain:

$$max. increment = X * 50/LC_{50}$$

and rearrangement yields

$$X = max. increment \times LC_{50}/50.$$

5. Let  $T$  denote the trigger value for the TER and by definition  $T = LC_{50}/exposure$  so substituting  $exposure = X = (max. increment \times LC_{50}/50)$  yields

$$T = LC_{50}/(max. increment \times LC_{50}/50)$$

and algebraic simplification yields  $T = 50/max. increment$ .

*Worked example (labelled by steps above).*

1. The solution to the Khoury model that yields 7 % reduction in colony size after 10 days is  $m_{7,10} = 0.195$ .
2. Therefore  $I = 0.195/0.154 = 1.27$
3. If  $m_E = 5.3\%$ ,  $max. increment = 0.27 \times 5.3 = 1.43$
4. Trigger value =  $50/1.43 = T = 34$

The ETR trigger values are calculated as follows based on daily mortality rates based on lifespan/mortality data of foragers retrieved from literature (see Appendix K. ):

	Lowest observed mortality	10th percentile	Median
<b>Daily background mortality</b>	5.3	7.8	13
<b>I</b>	1.27	1.27	1.27
<b>Max. increment</b>	$0.27 \times 5.3 = 1.43$	$0.27 \times 7.8 = 2.1$	$0.27 \times 13 = 3.5$
<b>TER Trigger</b>	34	23	14
<b>ETR Trigger</b>	0.03	0.04	0.07

The ETR trigger values for bumble bees and solitary bees were recalculated based on daily mortality rates of 4.4% (bumble bees) and 5% (*Osmia*) resulting in values of 0.024 and 0.027, respectively. An additional assessment factor of 5 is suggested to account for higher susceptibility of forager losses in bumble bees and uncertainties related to differences in species sensitivity distribution in solitary bees. This results in ETR triggers of 0.0048 and 0.0054 for bumble bees and solitary bees, respectively.

### Determining a trigger value for an acute oral exposure

The acceptable mortality (maximum increment above background level) is  $max. increment = (I - 1) \times m_E$

**Acute oral test** = acute mortality over two days

**Protection goal** = increase of mortality by a factor of 3 over two days, increment ( $I$ ) = 3

**Background mortality** ( $= m_E$ ) = 5.3%

**Acceptable mortality** ( $= max. increment$ ) =  $(I - 1) \times m_E = (3 - 1) \times 5.3\% = 10.6\%$

**Trigger value** =  $50/10.6 = T = 4.7$

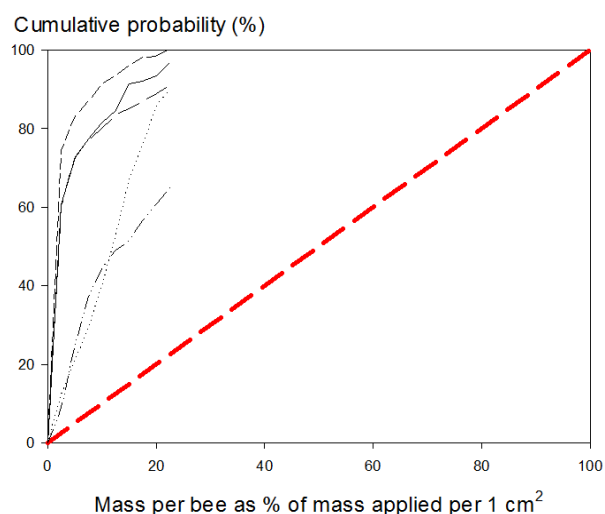
The acute oral ETR trigger values are calculated as follows based on daily mortality rates based on lifespan/mortality data of foragers retrieved from literature (see [Appendix K](#) on mortality rates):

	Lowest observed mortality	10th percentile	Median
<b>Daily background mortality</b>	5.3	7.8	13
<b>I</b>	3	3	3
<b>Max. increment</b>	$2 \times 5.3 = 10.6$	$2 \times 7.8 = 15.6$	$2 \times 13 = 26$
<b>TER Trigger</b>	4.7	3.2	1.9
<b>ETR Trigger</b>	0.2	0.3	0.5

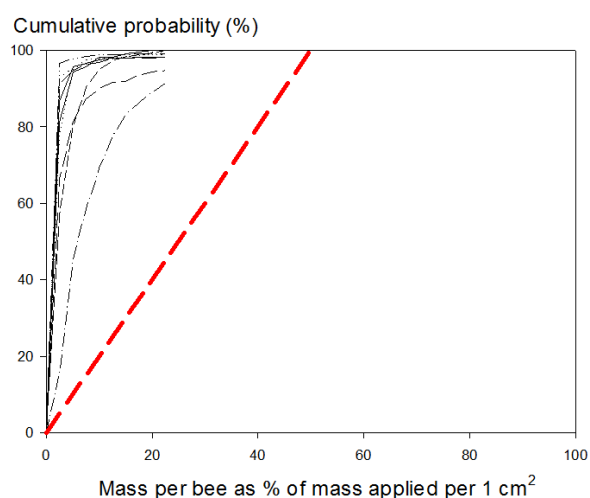
The acute oral ETR trigger values for bumble bees and solitary bees were recalculated based on daily mortality rates of 4.4% (bumble bees) and 5% (*Osmia*), resulting in ETR trigger values of 0.18 and 0.2 respectively. An additional assessment factor of 5 is suggested to account for higher susceptibility of forager losses in bumble bees and uncertainties related to differences in species sensitivity distribution in solitary bees. This results in ETR triggers of 0.036 and 0.04 for bumble bees and solitary bees, respectively.

### Determining a trigger value for an acute contact exposure

Koch and Weisser (Koch and Weisser, 1997) performed five field experiments after downwards spraying in *Phacelia* and nine field experiments after side/upwards spraying in apples. Koch and Weisser sprayed 20 g of a tracer per ha of sprayed area, which corresponds to 200 ng/cm<sup>2</sup>. The sprayed area was for the *Phacelia* defined as the surface area of the field and for the apples it was defined as the surface area of the fruit wall. We expressed the measured mass per bee as the percentage of the mass applied per cm<sup>2</sup>. Because the estimated one-sided surface area of a bee is this 1 cm<sup>2</sup>, a percentage on the horizontal axis of 100% would mean that a bee receives the dosage corresponding to its surface area. Figures M3 and M4 show that cumulative frequencies are usually close to 100% when the percentage of mass applied per cm<sup>2</sup> is about 20%, so far from the dose corresponding with the one-sided surface area of a bee.



**Figure M3:** Cumulative frequency distributions of contact exposure as measured by Koch and Weisser (1997) after downwards spraying in five field experiments. The five thin lines are the measured distributions and the thick dashed line is the conservative linear cumulative distribution assumed in the risk assessment (slope  $E = 1$ ). The horizontal axis is the % of mass applied per cm<sup>2</sup> because it is assumed that the surface area of a honey bee is 1 cm<sup>2</sup>.



**Figure M4:** Cumulative frequency distributions of contact exposure as measured by Koch and Weisser (1997) after sideward/upwards spraying in nine field experiments. The nine thin lines are the measured distributions and the thick dashed line is the conservative linear cumulative distribution assumed in the risk

assessment (slope  $E = 2$ ). The horizontal axis is the % of mass applied per  $\text{cm}^2$  because it is assumed that the surface area of a honey bee is  $1 \text{ cm}^2$

The next question is what is the total mortality of a population of foragers when exposed to a mass per bee that follows cumulative frequency distributions as shown in Figures M3 and M4.

We use the same conservative approach as above, i.e. the relationship between mortality,  $M$  (%), and mass per bee,  $m$  (mg), can be conservatively described with a straight line through the origin and the point ( $\text{LD}_{50}$ , 50%):

$$M = (50\%/\text{LD}_{50})m \quad (\text{M5})$$

where  $\text{LD}_{50}$  is the mass per bee ( $\mu\text{g}$ ) at 50% mortality.

We propose to describe the cumulative exposure probability also by a straight line through the origin and through the point (50%, 100%) for sideward/upwards spraying and through the point (100%, 100%) for downwards spraying; these are the thick dashed lines. These lines are more conservative than the measurements (e.g. at a exposure percentile of 50%, the thick lines give a higher mass per bee than the measurements). Please note, however, that the description is most important for a cumulative probability close to the 100th percentile because these are most critical for the effects. Please note also that the target of the exposure assessment is the 90<sup>th</sup> percentile case. Figure M3 shows five lines so the worst case of these five should be taken as the 90<sup>th</sup> percentile. Figure M4 shows nine lines, so the worst case measured is the 94th percentile and the last but one worst case is the 83<sup>rd</sup> percentile.

This conservative approach was followed because of the limitations of the data collected by Koch and Weisser (1997) and because it is in general undesirable to base a risk assessment on data from only one source. EFSA Panel on Plant Protection Products and their Residues (PPR) (2012a), p. 215) described these limitations as follows: Koch and Weisser (1997) considered only (i) two crops (apple orchards and *Phacelia*), (ii) one type of spray equipment for each of these two crops (an axial fan sprayer and a 12-metre boom sprayer), (iii) a fluorescent tracer and (iv) honey bees. Another limitation is that Koch and Weisser (1997) sampled bees entering a hive at the edge of treated fields so it is possible that some of the bees were not exposed because they foraged on another field. Koch and Weisser (1997) placed the hives at flowering stage next to the fields tree days before treatment to ensure that bees were foraging inside the treated fields.

In view of the foregoing it is recommended that such experiments are carried out in different crops with different types of spray equipment and considering also bumble bees and to include reports of weather conditions during these experiments. It is also recommended to compare contact exposure of tracers to that of formulated products to check whether studies with tracers can be used for exposure assessment of formulated products. Moreover it is recommended to measure both the contact exposure in the treated field and at the entrance of the hive to check whether all the bees were foraging in the treated field. It is recommended to avoid alternative foraging in these experiments as much as possible.

So we have now both a cumulative probability density function for exposure and the cumulative mortality (both a function of the mass per bee). Let us call the cumulative density function for exposure  $F_e$ . As shown in Figures M3 and M4 this can be approximated conservatively with a straight line through the origin:

$$F_e = E\varphi \quad (\text{M6})$$

where  $\varphi$  is mass per bee expressed as the percentage of mass applied per  $\text{cm}^2$  (%) and  $E$  is the dimensionless slope of the line shown in the graphs, so  $E = 1$  for downwards spraying and  $E = 2$  for sideward/upwards spraying.

For the risk assessment we need to relate  $F_e$  to the mass per bee,  $m$ . Let us assume that the deposition of substance onto the surface of the field is  $f_{dep}A$ , where  $f_{dep}$  is the fraction deposited (–) and  $A$  is the dose in kg/ha. A deposition  $f_{dep} A$  of 1 kg/ha corresponds to  $10^6$  mg/ $10^8$  cm<sup>2</sup>, so 0.01 mg/cm<sup>2</sup> so the mass per bee is given by:

$$m = (\varphi/100) f_{dep} A \text{ 0.01} \tag{M7}$$

Substitution of Eqn M7 into Eqn M6 gives:

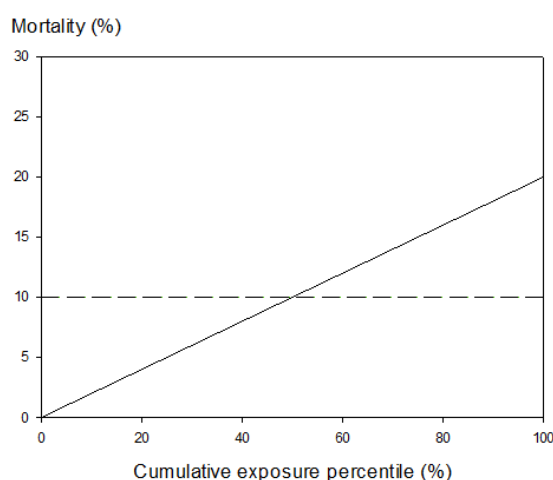
$$F_e = \frac{10^4 E m}{f_{dep} A} \tag{M8}$$

So we have now the cumulative exposure probability and the relationship between mortality and exposure and we want to know the total mortality of the forager population that results from this. By analogy with the approach of the cumulative profile plots (Verdonck et al., 2003) this can be calculated by plotting  $M$  as a function of  $F_e$  and by calculating the average  $M$  for  $F_e$  ranging from 0 to 100 %. This will give the total mortality of all foragers because the mortality of ‘each exposure percentile’ is given its appropriate weight. For example, if the exposure up to the 99th percentile is so low that  $M = 0$ , and the exposure of the last percentile is so high that  $M = 100\%$ , then the total mortality over the total cumulative exposure is 1% of all foragers.

Combining equations M5 and O8 gives

$$M = \frac{50 f_{dep} A}{10^4 LD50 E} F_e \tag{M9}$$

So the mortality  $M$  is directly proportional to the cumulative exposure percentile  $F_e$ . The basis of the risk assessment is the average mortality considering all exposure situations. This can be calculated by calculating the area under the curve and dividing by the length of the corresponding horizontal axis. This is illustrated by the example shown in Figure M5. In this graph the mortality increases linearly from 0 to 20% as a function of the cumulative exposure percentile and the average mortality is 10%.



**Figure M5:** Mortality percentage as a function of the cumulative exposure percentile. The solid line is an example relationship and the dashed line is the corresponding average mortality.

In the case of Eqn M9, the average  $M$  for  $F_e$  between 0 and 100% becomes:

$$M_{ave} = \frac{50 f_{dep} A}{10^4 LD_{50} E} \int_0^{100} F_e dF_e = \frac{50 f_{dep} A}{10^4 LD_{50} E} \frac{1}{2} 100^2 = \frac{2500 f_{dep} A}{10^4 LD_{50} E} = \frac{f_{dep} A}{4 LD_{50} E} \quad (M10)$$

Rearranging Eqn M10 and substituting  $HQ = f_{dep} A/LD_{50}$  gives:

$$HQ = 4M_{ave}E \quad (M11)$$

The data of Koch and Weisser show that bees carried higher residues when they were exposed in a field with downwards spray than in one with sideward/upwards spraying. Therefore, it was considered appropriate to calculate two separate HQ values for these two different application techniques.

So for downwards spraying ( $E = 1$ ) the result is:

$$HQ = 4M_{ave} \quad (M12)$$

In case of sideward/upwards spraying ( $E = 2$ ) the result becomes:

$$HQ = 8M_{ave} \quad (M13)$$

The acceptable daily mortality,  $M_{acc}$  (= maximum increment), can then be set equal to  $M_{ave}$  because the risk assessment is based on the average mortality of the whole population of foragers as explained above.

Please note that Eqns M12 and M13 are based on the same acceptable mortality criterion. The reason for the twofold more strict criterion for downwards spraying is that a dose of 1000 g/ha when downwards sprayed results in a higher mass per bee exposed than when sideward or upwards sprayed. Because the exposure input to the HQ is the dosage, the higher exposure in case of downwards spraying leads to a more strict HQ criterion.

Please note that this is based on conservative approximations of the curves for the cumulative exposure and for the mortality.

The above analysis applies to a case where the mass deposited on the surface area of the field (i.e.  $f_{dep} A$ ) is known. In case of the field margins and the attractive adjacent crops, this mass deposited itself is a stochastic variable that depends on the wind angle, wind speed, etc. As described by Eqn M7, the mass per bee is the product of the mass deposited on the surface area ( $f_{dep} A$ ) and the fraction of this deposition that gets into contact with the bee ( $\phi/100$ ). In view of time limitations we are unable to provide probabilistic analyses for these cases. Instead we propose to use a 90th percentile for the mass deposited onto these crops because this is very likely to result in a conservative mass to which the bees are exposed for these types of crops. Further probabilistic analyses considering realistic landscape geometries and a drift deposition that depends on wind angle and wind speed are needed to obtain a more realistic contact exposure assessment for honey bees.

The HQ trigger values are calculated as follows based on daily mortality rates based on lifespan/mortality data of forager honey bees retrieved from literature (see [Appendix K](#)):

	Lowest observed mortality	10th percentile	Median
Daily background mortality	5.3	7.8	13
<i>I</i>	3	3	3
Max. increment	2 x 5.3 = 10.6	2 x 7.8 = 15.6	2 x 13 = 26
HQ trigger= 4 x max.	42.4	62.4	104

<b>increment (downwards spray)</b>			
<b>HQ trigger (upwards and sideward spray) = 8 × max. increment</b>	84.8	124.8	208

The HQ trigger values for bumble bees and solitary bees were recalculated based on daily mortality rates of 4.4% (bumble bees) and 5% (*Osmia*) resulting in the following values: HQ (downwards spray) = 35.2 (bumble bees) and 40 (solitary bees), HQ (upwards/sideward spray) = 70.4 (bumble bees) and 80 (solitary bees). An additional assessment factor of 5 is suggested to account for higher susceptibility of forager losses in bumble bees and uncertainties related to differences in species sensitivity distribution in solitary bees. This results in the following trigger values: HQ (downwards spray) = 7 (bumble bees) and 8 (solitary bees), HQ (upwards/sideward spray) = 14 (bumble bees) and 16 (solitary bees).

For practical reasons it is suggested to round the HQ trigger values for honey bees to 42 (downwards spray) and 85 (upwards and sideward spray).

### ETR trigger value for larvae

The endpoint for larval toxicity is based on a concentration that does not cause any effects in the laboratory study compared with controls (NOEC). Therefore, it could be argued that the protection goal of negligible effects is achieved if the 90th percentile exposure estimate does not exceed the NOEC. If this endpoint is used without any assessment factor, it is assumed that exposure and effects under laboratory conditions equate to exposure and effects under field conditions. However, uncertainties remain with regard to extrapolation of the test results to field conditions. Ideally, such uncertainties should be quantified and translated into an assessment factor. Unfortunately, such data were not available and the trigger value was determined on the basis of the available information. Outlined below is a summary of the key parameters in the larval risk assessment as well as an indication as to what effects the parameter could have on the selection of a trigger value.

**Inter-species variability**—normally a trigger value has to incorporate potential inter-species variability, e.g. reading across from acute toxicity of a test substance to the bobwhite quail to the skylark. Fortunately, in the case of honey bees, the test species is the species to be assessed; thus, inter-species variability does not exist. What does exist, however, is intra-species variability. This is not accounted for specifically in other areas of ecotoxicological risk assessment, i.e. no account is made of the potential differences in sensitivity of various subspecies of yellow wagtail in the bird risk assessment. This does not mean that intra-species variability is not important and should not be taken into account. There are numerous subspecies of honey bees—for example *Apis mellifera iberica*, *Apis mellifera ligustica* and *Apis mellifera carnica*. Little is known as to the differences in sensitivity of one subspecies compared with another, for example whether the species tested in the laboratory and the field are more or less sensitive than those likely to be exposed when the pesticide is used (Ladas, 1972) (Suchail et al., 2000).

**Temporal factors**—it is possible that sensitivity of honey bees may change during the year, i.e. foragers tested or exposed in the spring may be more or less sensitive than those exposed in the summer (Meled et al., 1998).

**Laboratory to field extrapolation**—the larval toxicity study is carried out under laboratory conditions where, on the one hand, exposure is worst case in that the only food available is treated, but, on the other hand, the conditions are best case in that food is available and temperature conditions are ideal. As regards exposure under field conditions, it is noted that larvae are fed processed food by

nurse bees. Processed food consists of royal jelly, as well as pollen and nectar. It is possible that under field conditions there may be both degradation and metabolism of the active substance prior to the larvae being fed. It should be noted that the concentration in larvae food should reflect the appropriate percentile and be in line with the exposure chapter. Therefore, in light of this final point, as well as the above issue, it is considered, as regards exposure, that this should be in line, and as regards environmental conditions, that the laboratory conditions should reflect the ideal conditions within the colony. It can be concluded that there are uncertainties in extrapolating from the laboratory to the field, although they should be minimal.

**Inter-study variability**—according to the SANCO guidance on technical equivalence, inter-study variability can be a factor of 3 (see:

[http://ec.europa.eu/food/plant/protection/evaluation/guidance/wrkdoc23\\_en.pdf](http://ec.europa.eu/food/plant/protection/evaluation/guidance/wrkdoc23_en.pdf)). Given that the larval study is, as yet, unvalidated and unadopted its reproducibility and repeatability is unknown, however it is hoped that inter-study variability will be within a factor of 3.

**Overall conclusion**—in light of the above, it is not considered appropriate to have a trigger value of 1, i.e. assume that the laboratory study exactly reflects the field situation. In determining the size of any trigger value it is essential to have a clear indication as to the potential effects of the above uncertainties. This is currently not available. In order to determine a suitable trigger value the following is proposed:

- Inter-species variability—no need to consider as only one species
- Intra-species variability—considered unlikely to vary by more than an order of magnitude
- Temporal effects—unlikely to result in a difference in sensitivity of more than an order of magnitude
- Laboratory to field extrapolations—if the exposure estimates are appropriate, then the major uncertainty is related to the conditions in the field compared with the conditions in the laboratory; the latter are likely to be consistent and ideal, whilst the conditions under field conditions are likely to be more variable.
- Inter-study variability—as outlined above this could vary and should be within a factor of 3.

The uncertainty related to exposure makes the laboratory endpoint more conservative since larvae (at least the first stages) are fed with processed food and it is expected that residues in this processed food is lower. The other sources of uncertainty can be in both directions, making the assessment either more conservative or less conservative.

On the basis of the above, it is clear that any assessment factor should be greater than 1, it is also likely that an assessment factor of 10 is overprecautionary (i.e. the above uncertainties are unlikely to result in a difference of more than 10 between the effects seen in the laboratory and those in the field). Thus, it is proposed that an assessment factor of 5 (ETR trigger = 0.2) is used. This will most likely cover the inter-study variability as well as other uncertainties and variables.

## Appendix N. EXPOSURE ASSESSMENT FOR BEES FOR NECTAR AND POLLEN ENTERING THE HIVE

### 1. Introduction

As described in [chapter 5](#), the risk to bees via consumption of nectar and pollen in the hive is assessed using parallel tiered approaches for the effect and exposure assessments both for spray applications, seed treatments and granule applications. Sections 5.1.7 and 5.1.8 described the general approach for the exposure assessments of the concentrations in nectar and pollen entering the hive, considering the different types of plants. This appendix describes the details of this exposure assessment.

The exposure assessment is based on tiered approaches described by flow charts (see, for example, Figure N1). So let us explain here the rules of logic in these charts. If a box contains a question, then it is usually followed by a ‘yes’ and a ‘no’ option. If a box does not contain a question, then it is a possible next step in the tiered approach or it is a conclusion (e.g. if a box says ‘acceptable risk’). If an activity in a box leads to the conclusion that the risk is acceptable, there is no need to continue in the flow chart. Not all boxes contain questions because this would lead to overly crowded flow charts. These flow charts deal only with the exposure assessments (so only the right column of the combined effect and exposure scheme as shown in Figure 2). Therefore, if a box says ‘acceptable risk’, this is always based on a conclusion from the effect assessment (following the concept of the parallel effect and exposure tiered assessment schemes as explained in section [5.1.4](#)).

The aim of the exposure assessment is to provide input into the assessment of the daily residue intake rate of bees (see [Appendix F](#)). This residue intake rate ( $RI$ ) is expressed in  $\mu\text{g}/\text{day}$  when used in the effect assessment.  $RI$  is calculated as:

$$RI = \frac{PEC_{\text{pollen}} C_{\text{pollen}} + PEC_{\text{nectar}} C_{\text{nectar}}}{1000} \quad (\text{N1})$$

where  $PEC_{\text{pollen}}$  and  $PEC_{\text{nectar}}$  are the ‘predicted environmental concentrations’ ( $\text{mg}/\text{kg}$ ) in pollen and nectar, respectively, and  $C_{\text{pollen}}$  and  $C_{\text{nectar}}$  are the consumption rates of pollen and nectar of a bee species ( $\text{mg}/\text{day}$ ).

We use the abbreviation PEC because this is commonly used for the other exposure assessments in EU dossiers; it should be noted that these PECs may also be derived from measurements. Division by 1000 is necessary because the numerator of Eqn N1 generates  $RI$  in  $10^{-6} \text{ mg}/\text{day}$ , i.e.  $10^{-3} \mu\text{g}/\text{day}$ , whereas  $RI$  should be in  $\mu\text{g}/\text{day}$ .

The consumption rate of nectar is assessed as the quotient of the intake rate of sugar of a bee species ( $d_s$  in  $\text{mg}/\text{day}$ ) and the sugar content of the nectar ( $m_s$  in  $\text{kg}/\text{kg}$ ), defined as mass of sugar divided by mass of nectar. This gives:

$$RI = \frac{PEC_{\text{pollen}} C_{\text{pollen}} + PEC_{\text{nectar}} \frac{d_s}{m_s}}{1000} \quad (\text{N2})$$

The concentrations in nectar and pollen are based on the concept of the residue unit dose ( $RUD$ ) which is defined as the residue in  $\text{mg}/\text{kg}$  at a dose of  $1 \text{ kg}/\text{ha}$ . So usually the approach is to calculate the PEC as

$$PEC = \delta RUD \quad (\text{N3})$$

where  $\delta$  is the dose ( $\text{kg}/\text{ha}$ ).

As described in Chapter 5, concentrations in plants other than the treated crop should be assessed (e.g. plants in field margins). In such cases, Eqn N3 does not apply because only a fraction of the dose will be deposited on these plants. Therefore we need to generalise Eqn N3 into:

$$PEC = f_{dep} \delta RUD \quad (N4)$$

where  $f_{dep}$  is the fraction of the dose deposited (–) on the plant.

So Eqn N2 can then be rewritten as:

$$RI = f_{dep} \delta \frac{RUD_{pollen} c_{pollen} + RUD_{nectar} \frac{d_s}{m_s}}{1000} \quad (N5)$$

In the lower tiers of the exposure assessment, so-called shortcut values (SVs) are used. SV is defined as:

$$SV = \frac{RUD_{pollen} c_{pollen} + RUD_{nectar} \frac{d_s}{m_s}}{1000} \quad (N6)$$

So SV is the daily residue intake rate of a bee ( $\mu\text{g}/\text{day}$ ) for a deposition of 1 kg/ha. For some of the bees assessed, cumulative values of the RI over periods of 5 and 30 days are needed and then SV is also calculated over 5 and 30 days.

Please note that different values of  $C_{pollen}$ ,  $d_s$  and  $m_s$  have to be used when calculating the residue intake rates for the different bees, as explained in [Appendix J](#).

For part of the higher tiers (i.e. 2<sup>nd</sup> tier), the residue intake rates can be calculated with Eqn N2 or Eqn N5 by Monte-Carlo simulations for the different types of bees and for the acute and chronic risk assessment. EFSA provides a calculator tool for performing a refined SV estimations (SV includes the variables that can be refined (e.g. residue levels, sugar content in nectar). The tool will allow to run Monte-Carlo simulations for residue intake rates of a single hives considering the median feed consumption of these hives (see [Section 5.1.2](#) for the background of using this also for the bumble bees and solitary bees). The median is used because this is considered to give the most appropriate linking to the effect assessment (considering that the assessment of the mortality is based on a linear dose response curve which is likely to be a conservative approach, so using a higher exposure percentile than the median will probably lead to an overly conservative risk assessment). This residue intake rates (i.e. SVs) are calculated for a large number of hives (at least 1000) and from this the hive with the 90<sup>th</sup> percentile intake rate is determined. In order to describe the variability/uncertainty of the SVs, the simulation is repeated 1000 times (1000 iterations such as they were 1000 fields) by the tool resulting in a set of 90<sup>th</sup> percentile SV. The median of these 90<sup>th</sup> percentile SVs should be used for the exposure assessment. If measurements of the sugar content or estimations for refined pollen consumption are available for crop plants (treated crop, adjacent crop and succeeding crop) (see [Appendix S](#)), these should also be used in the simulations. If these are not available, the default values should be used as described in [Appendix J](#) (Table J1 and Section 3.3). For the weeds in the treated field and the plants in the field margins, sugar content and pollen consumption should always be used as described in [Appendix J](#).

In the calculations for intake rates of single hives, it is the intention to use fixed values for the sugar content and for the RUDs for nectar and pollen because these are considered to vary mainly from location to location (in case information on their variation would be available for single fields then this could in principle also be used as input for the Monte-Carlo simulations but in lack of experience, currently no further guidance can be given for this option.

The remainder of this appendix contains some twelve flow charts of tiered exposure approaches. Part of these flow charts contain boxes that require the assessment of the spatial variation of the RUD-values because this variation is considered a main driver of the 90<sup>th</sup> percentile intake case. If the exposure is assessed for such a box, the measured data of the RUDs for nectar and pollen from the different locations (based on field measurements of these RUDs at a number of locations as described in [Appendix G](#)) should be used as input for the calculator tool which will derive distributions from the measured data (e.g. assuming log-normal distributions). For the boxes in the flow charts that require assessment of the RUDs without the spatial variation, the [Monte-Carlo simulations](#) have to be limited to the assessment of the median consumption of a single hive. For such boxes the exposure refinement is targeted usually at assessment of the 90<sup>th</sup> percentile deposition case (so the  $f_{dep}$  value in Eqn N5), e.g. in case of spray or dust drift deposition onto field margins and adjacent crops. The background of this is that the spatial variation in deposition is considered much larger than the spatial variation of the RUDs (e.g. because of the effect of variations in wind speed and of the wind angle on the deposition).

This guidance for the calculation of the residue intake rate based on Monte-Carlo simulations should be considered as a first step because no experience has been gained so far with the tool and with the application of the procedure in regulatory practice. So there is need for this guidance to develop further in future.

In case measurements are available for the decline of the RUDs with time, Monte-Carlo simulations can be carried out to assess the time-weighted average (TWA) residue intake rate based on the following equation:

$$RI_{TWA} = \frac{f_{dep} \delta}{1000} \left( \frac{RUD_{pollen,0} C_{pollen}}{k_{pollen} t} (1 - \exp(-k_{pollen} t)) + \frac{RUD_{nectar,0} \frac{d_s}{m_s}}{k_{nectar} t} (1 - \exp(-k_{nectar} t)) \right) \quad (N7)$$

where  $RUD_{pollen,0}$  is the  $RUD_{pollen}$  at time zero,  $RUD_{nectar,0}$  is the  $RUD_{nectar}$  at time zero,  $k_{pollen}$  is the first-order rate coefficient ( $d^{-1}$ ) for the decline of the concentration in the pollen,  $k_{nectar}$  is the first-order rate coefficient ( $d^{-1}$ ) for the decline of the concentration in the nectar, and  $t$  is the time period (d) over which the TWA is calculated.

With analogy to equation N6, the SV is defined as the RI at a dose or deposition of 1 kg/ha. So the expression for the  $SV_{TWA}$  becomes:

$$SV_{TWA} = \frac{1}{1000} \left( \frac{RUD_{pol,0} C_{pol}}{k_{pol} t} (1 - \exp(-k_{pol} t)) + \frac{RUD_{nec,0} \frac{d_s}{m_s}}{k_{nec} t} (1 - \exp(-k_{nec} t)) \right) \quad (N8)$$

The calculator tool for performing the simulations will also include the option of Eqn N8.

This appendix is further restricted to the assessment of the PECs in nectar and pollen based on the RUDs for nectar and pollen and the fraction of the dosage deposited ( $f_{dep}$ ) onto the different types of plants.

## 2. Exposure assessment for spray applications

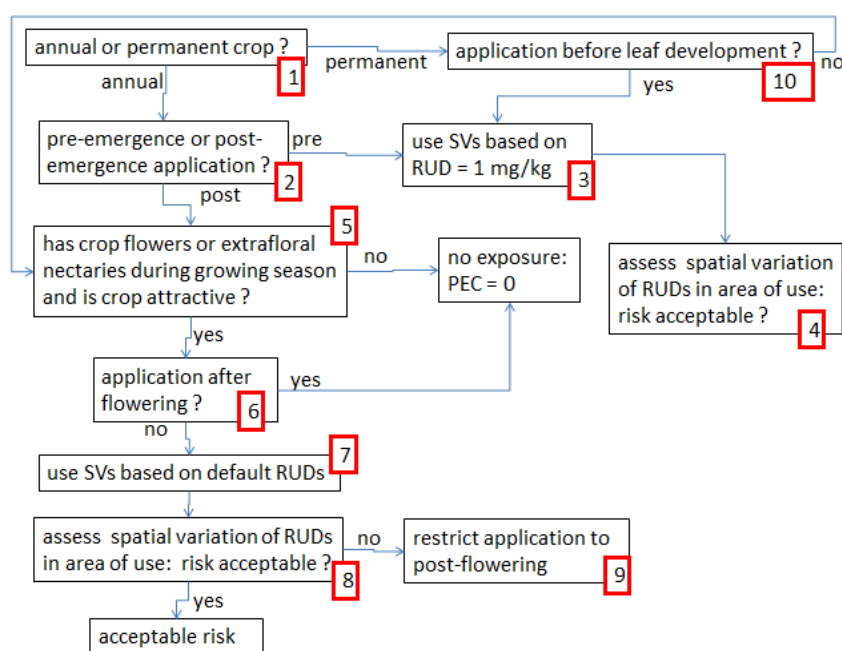
### 2.1. Introduction

The overview of the exposure assessment for spray applications is described in [section 5.1.7](#), and Figure 5. The following sections deal with the exposure assessments as required for the boxes 2, 3, 4, 5 and 6 of Figure 5.

### 2.2. Concentrations in pollen and nectar in the treated crop after spray application

The exposure assessment for the PECs for nectar and pollen in the treated crop is described in the flow chart in Figure N1. At the start (box 1), a distinction is made between annual and permanent crops. The annual crops continue in box 2 and pre-emergence and post-emergence applications are treated differently. For the pre-emergence applications a default RUD of 1 mg/kg (box 3) is considered acceptable based on the default value proposed in the EPPO scheme for the soil and seed treatments (Alix and Lewis, 2010) and also supported by pertinent data in Appendix F. If this assessment does not result in acceptable risk, spatial variation of the RUDs in the area of use has to be assessed (box 4) by field measurements under normal agricultural conditions (see [Appendix G](#) for guidance for performing such measurements). In case of post-emergence applications in annual crops, whether the crop has flowers or extrafloral nectaries during the growing season (if not, there is no nectar and pollen) and if it is attractive to bees (if not no nectar and pollen is transported to the hive) is checked (box 5). Next, whether the substance is sprayed after flowering (box 6) is checked. If no, there is no exposure. Otherwise the concentrations in nectar and pollen have to be assessed and as a first step this can be based on the default SVs described in [Appendix J](#) (box 7). If the risk is still not acceptable, the spatial variation of the RUDs in the area of use has to be assessed (box 8) by field measurements under normal agricultural conditions (see [Appendix G](#) for guidance for performing such measurements). Such measurements will also automatically include the uptake of substance via the crop roots and its transport to pollen and nectar. These measurements are used to assess a higher-tier residue intake rate as described in Section 1 of this Appendix. If box 8 does not lead to an acceptable risk, the exposure may be mitigated by restricting the application to the post-flowering period (box 9). In the case of permanent crops, the first step is to check whether application is before leaf development (box 10). If yes, use of the default RUD of 1 mg/kg is considered acceptable. This is based on expert judgement: uptake through wood-type surfaces of the permanent crop is expected to be small. If application is after leaf development has started, the scheme for the permanent crops continues in box 5 and is further identical to the approach for the annual crops.

In some circumstances, such as (but not restricted to) herbicidal applications in crops planted in wide rows (i.e. orchards, vines, strawberry, bush and cane crops), the pesticide application is not crop directed (e.g. spray application between the rows or under the trees). For those situations no exposure of the crop could be considered (i.e. PEC=0). It is noted that exposure to bees (especially if the crop is in full flowering or shortly before) cannot completely be ignored even for those cases (i.e. some part of the spray liquid drifted to the crop or via the roots of the crop). However it was considered that these routes of exposures are unlikely or negligible. Although it is recommended that further developments should confirm these consideration in the near future.



**Figure N1:** Flow chart for the exposure assessments of the PECs for nectar and pollen in the treated crop after spray applications. The box numbers refer to the general text above. See second paragraph of this appendix for the explanation of the rules of logic of the flow chart

### 2.3. Concentrations in pollen and nectar in weeds in the treated field after spray application

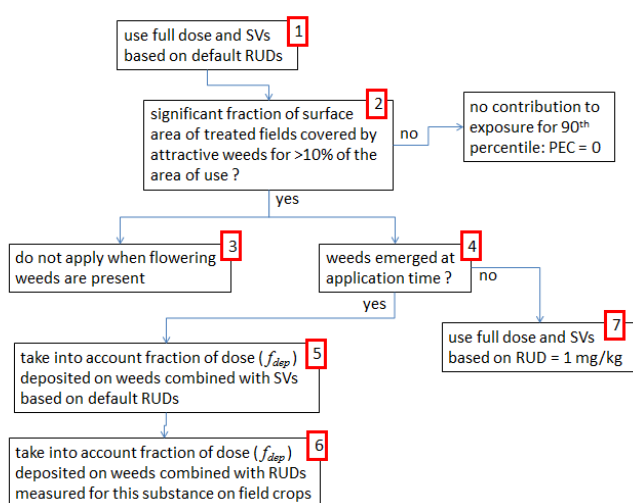
The first step for the PECs for weeds in the treated field is to estimate the PEC using the default SVs ([Appendix J](#)) in combination with the full dose (box 1 in Figure N2).

These plants may flower at any time, so the application time does not have an influence on the RUDs for weeds in the treated field. If the first step results in an unacceptable risk, it may be checked whether it is likely that a significant fraction of the surface area of the treated fields is covered by weeds at the application time. If this is likely in less than 10% of the area of use of the substance, no weeds will occur in a 90th percentile case and thus their exposure can be ignored (box 2). For example, weeds are usually not abundant in annual crops - abundant weed growth is more likely to occur in, for example, orchards. However, at this moment no guidance for the assessment of the abundance of weeds is available for most crops. We therefore recommend developing a guidance for this at the EU level in the near future. Until such a guidance is available, the box can be ignored and the risk assessor can go immediately to box 3 or 4 (conservative approach).

Next there are two parallel steps in the flow chart: (i) mitigate the risk by not applying when flowering weeds are present (box 3) or (ii) check whether weeds are likely to have emerged at application time (box 4). For applications where weeds have not yet emerged, it is considered acceptable to use a default RUD of 1 mg/kg, (i.e. the default value proposed in the EPPO scheme for the soil and seed treatments (Alix and Lewis, 2010) and supported by pertinent data in [Appendix F](#)). For the other applications the exposure can be refined by taking into account the fraction of the dose deposited on the weeds (box 5). Further details regarding this fraction of the dose deposited can be found in Appendix E of EFSA (2009) or Appendix X of this guidance document. In case box 5 does not lead to acceptable risk, we propose in box 6 to refine the  $RUD_{nectar}$  for weeds by using RUDs measured for this substance in field crops in full flower (e.g. oilseed rape). For pollen it is proposed to measure the RUDs in *Phacelia* as a proxy for weeds. This approach of using plants other than weeds is based on the assumption that the RUD of a substance is more driven by substance properties than by plant properties. This is likely to be the case, but it is uncertain whether this assumption is defensible for the full range of plants and substances. Therefore we recommend underpinning this approach by analysing

available data and further research. The alternative would be to measure RUDs for the most relevant weed species; we do not advise this because the composition of attractive weed species in treated fields is likely to be very variable and we are not aware of data on their distribution in treated fields across the EU.

Because flowering weeds will often be present in the field at the time of application, the assessment of the PEC in weeds in the treated field will often trigger the biggest exposure assessment problems of all the assessments in the flow chart of Figure 5: , particularly if the risk mitigation option (box 3 of Figure N2) is for not possible. In such cases the landscape-level exposure assessment (yet to be developed) could be a useful higher tier solution, because weeds are unlikely to be present on a large fraction of the surface area of the treated field.



**Figure N2:** Flow chart for the exposure assessments of the PECs for nectar and pollen in weeds in the treated field after spray applications. The box numbers refer to the general text above. See second paragraph of this appendix for the explanation of the rules of logic of the flow chart.

## 2.4. Concentrations in pollen and nectar in plants in field margins after spray application

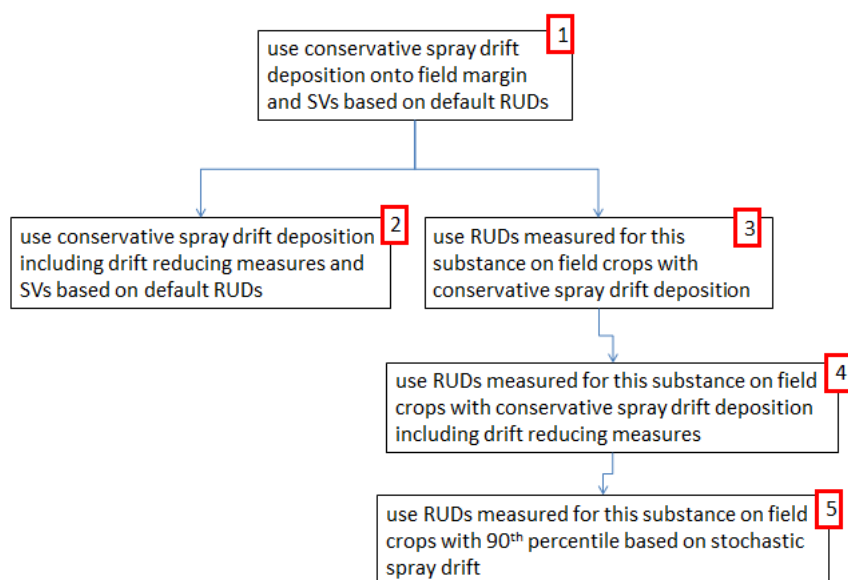
Flowering field margins can always be present at the application time, so their exposure has to be assessed. The target is the 90th percentile of the average concentration in nectar or pollen that enters a hive at the edge of the treated field. So it therefore seems justifiable to consider the average concentration of all attractive plants in the whole field margin of a treated field as the basis of the assessment. There are a priori no reasons to assume that bees would preferably forage more on contaminated parts of the field margin than on parts that are not contaminated (e.g. because they were upwind during application).

The first step to assess pollen and nectar concentration in field margins is to calculate PECs based on shortcut values (Appendix J) and default conservative spray drift deposition (box 1 of Figure N3). See Appendix H for interim guidance for spray drift deposition. The figures are 0.92% for field crops, 9.7% for early fruit, 5.2% for late fruit, 0.90% for early grapevine, 2.7% for late grapevine and 6.4 % for hops.

If the risk is not acceptable, the spray drift can be reduced with risk mitigation measures (box 2). The alternative is to refine the RUDs for plants in field margins by using RUDs measured for this substance in field crops in full flower (box 3). This is the same approach as proposed for the weeds in the treated field in the previous section, and has thus the same uncertainties. If the risk is not yet acceptable, drift reduction measures can be applied (box 4). If the risk is still not acceptable, the spray

drift can be refined by calculating a 90<sup>th</sup> percentile deposition using a stochastic model (box 5); see Appendix H. for the proposed approach based on this stochastic model.

As described before, the exposure assessment is based on the conservative assumption that bees forage exclusively on the type of the plant considered (here the flowering plants in the field margin). This is likely to overestimate exposure, especially for plants in field margins because the surface area of field margins is relatively small at the landscape level.



**Figure N3:** Flow chart for the exposure assessments of the PECs for nectar and pollen in the field margin of treated crops after spray application(s). The box numbers refer to the general text above. See second paragraph of this appendix for the explanation of the rules of logic of the flow chart

## 2.5. Concentrations in pollen and nectar in adjacent crops after spray application

As described before, a substance that is sprayed onto a treated crop that is not flowering at the time of application may lead to effects on an adjacent crop that is flowering at the time of application. Consider for example two adjacent apple orchards of which the treated orchard is not flowering whereas the adjacent orchard is flowering, or the spraying of a potato crop that is adjacent to a flowering oilseed rape field.

Following the same reasoning as that applied to field margins, we propose to consider the average spray drift deposition in the whole adjacent crop field. There is a priori no reason to assume that bees would preferably forage more on the contaminated strip of adjacent crop that is closest to the treated field.

The first step in the exposure assessment for adjacent crops (box 1 in Figure N4), is to calculate the *PEC* using the *SVs* based on the default *RUDs* (see [Appendix J](#) and [Appendix F](#)) and on the conservative default spray drift deposition. See Appendix J for interim guidance on spray drift deposition. The figures are 0.33% for field crops, 6.6% for early fruit, 3.1% for late fruit, 0.47% for early grapevine, 1.43% for late grapevine and 4.1% for hops. These values are lower than those for the field margins (previous section) because for the adjacent crop the average deposition over the full width of the adjacent field is considered, as explained in [Appendix H](#).

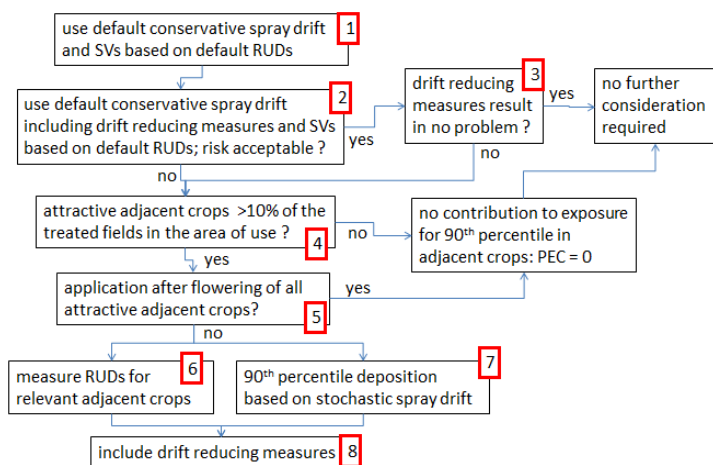
If the risk is not yet acceptable, the exposure can be mitigated by applying drift reduction measures (box 2). If the risk is acceptable and if the drift reduction measures result in no problem (box 3), then the problem is solved. Otherwise it can be checked whether there is an attractive adjacent crop (see

Appendix D. in an area bigger than 10% of the surface area of the treated fields (box 4). If this is not the case, the 90th percentile hive is unlikely to be influenced by an attractive adjacent crop and the exposure resulting from these plants can be ignored. At this moment the assessment in box 4 cannot be performed easily because no geostatistical analyses of the desired frequencies of occurrence of attractive crops are available. We recommend such analyses be performed at the EU level using crop maps that are currently available at a resolution of 1 km<sup>2</sup> for all EU countries (e.g. <http://eusoiils.jrc.ec.europa.eu/library/Data/EFSA/>).

Until the results of these analyses are available, this box can be ignored and the exposure assessment can continue assuming that this percentage is indeed above 10 % (the conservative approach because the exposure has to be assessed, in any case). The next step is to check whether the proposed application is after flowering of the attractive adjacent crops (box 5). If yes, the PEC can be assumed to be zero. If no, there are two options. The first is to measure *RUDs* for the relevant adjacent crops (box 6). Relevant means only those attractive adjacent crops that would, in isolation, lead to a ‘no’-answer in box 5. If there is more than one adjacent crop left, both the percentage of treated fields that have this adjacent crop and the attractiveness of the adjacent crop may be considered for setting priorities for *RUD* measurements.

The second option is to refine the 90<sup>th</sup> percentile spray drift deposition using a modelling study based on a stochastic wind angle and wind speed (box 7; see [Appendix H](#) for details of such a modelling study). The 90<sup>th</sup> percentile deposition should be based on the spatial population of hives as defined in the exposure assessment goal, i.e. all hives at the edge of treated fields. So if the relevant attractive adjacent crops only occur for, say, 20% of the treated fields, then the 90<sup>th</sup> percentile deposition can be assessed by taking the 50<sup>th</sup> percentile of the spray drift deposition probability density function (because the 90<sup>th</sup> percentile is the 50<sup>th</sup> percentile of the top 20% of the statistical population). See [Appendix J](#) for the general approach for assessing such percentiles.

If the risk is still not acceptable, box 8 provides the risk mitigation option of employing drift-reducing measures.



**Figure N4:** Flow chart for the exposure assessments of the PECs for nectar and pollen in adjacent crops after spray applications. The box numbers refer to the general text above. See second paragraph of this appendix for the explanation of the rules of logic of the flow chart.

## 2.6 Concentrations in pollen and nectar in plants in permanent crops in the next year and in succeeding annual crops after spray application

For permanent crops it is possible that soil residues of substances may lead to root uptake in the following year and that these residues are subsequently transported via the plants to nectar and pollen (especially for systemic substances). This may also happen for annual crops that are grown one year after the treated annual crop. Vegetables such as cabbage, carrots and beans may be grown twice in a growing season (e.g. six of the nine FOCUS groundwater scenarios have been parameterised for such double crops (FOCUS (2009))). So a spray application to the first crop may lead to uptake of substances via the roots in the second crop, followed by accumulation in the nectar and pollen of this second crop. This may be relevant for attractive double crops such as beans. This section provides guidance for the exposure assessment for nectar and pollen in these three types of crop scenarios.

Root uptake of substances seems to occur for all organic micropollutants, and seems to be mainly a function of the octanol–water partition coefficient and the molar mass (Sur et al., 2012). So it is impossible to assume a priori that non-systemic substances are not transported to nectar and pollen. Therefore, this exposure assessment applies to both non-systemic and systemic substances. We recommend analysing available data on residues in nectar and pollen resulting from root uptake to underpin the assumption that non-systemic substances are not transported to nectar and pollen in amounts that could become relevant for the risk assessment of bees. If this can, indeed, be underpinned, this exposure assessment scenario could be limited to systemic substances.

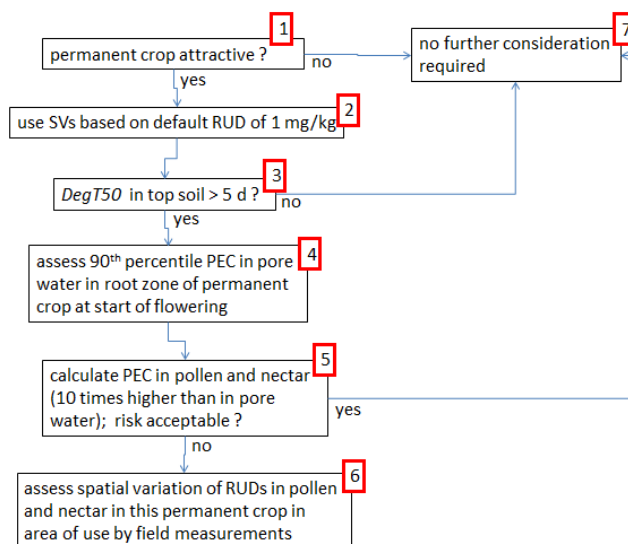
There is a consensus in literature that the plant uptake of PPPs and their metabolites at a certain depth in soil is proportional to their concentration in the pore water in the soil at that depth. This concept has been used for decades in the simulation models that are used for the regulatory assessment of leaching to groundwater and surface water at national and EU levels (e.g. Leistra and Dekkers (1977)). We therefore propose using the average pore water concentration in the root zone of the plant as a criterion to assess the likelihood of significant plant uptake (as a lower tier approach).

The next question is then how this pore water concentration is related to the concentrations in nectar and pollen. The first consideration is that the concentration in the nectar and pollen could be considerably larger than the concentration in the water that is taken up by the roots (especially for systemic substances). The second consideration is that the density of pollen and nectar is in the order of 1 kg/L, so a concentration of 1 mg/L in nectar or pollen corresponds to about 1 mg/kg. Therefore, it is proposed to assume that the concentration in nectar and pollen (in mg/kg) is 10 times higher than that in the pore water concentration (in mg/L).

We first consider the exposure assessment for permanent crops in the year after application (Figure N5). Box 1 tests whether the permanent crop is attractive. In the next step (box 2) SVs are calculated assuming a default RUD of 1 mg/kg. This is based on the expert judgement that the pore water concentration in the root zone in the next year is unlikely to exceed 0.1 mg/L. The next step (box 3) is a simple trigger for the  $DegT_{50}$  in topsoil at 20 °C and at a moisture content at field capacity. The  $DegT_{50}$  is the half-life in the soil matrix in soil (so excluding dissipation processes at the soil surface). This is part of the list of endpoints for Fate and is thus readily available. The concept behind this trigger is that if the  $DegT_{50}$  is short enough the pore water concentration in the root zone will be low enough one year after application to result in negligible exposure. We propose  $DegT_{50} > 5$  days. The trigger value has to be chosen so that the later steps in the flow chart are unnecessary, even for the most toxic substance, the most critical scenario, and the highest application rate. The proposed value of five days is tentative and will have to be underpinned by scenario calculations for the full range of substance properties. If this trigger is exceeded, the 90th percentile of the average pore water concentration in the root zone at the time of the start of flowering the next year has to be assessed (box 4). This 90th percentile refers to the area of use of the substance (considering the variability in meteorological conditions from year to year). Scenarios have not yet been developed for this 90th percentile. Until these scenarios become available, we propose to use the FOCUS groundwater

scenario that is most relevant for the area of use of the substance (these scenarios have been parameterised for apples for all nine scenario locations; FOCUS, 2009). These FOCUS scenarios intend to assess the 90th percentile of the pore water concentration leaching at one metre depth. A scenario selection procedure depends on the target quantity: so it can be expected that a 90th percentile scenario for the leaching concentration at one metre depth will differ significantly from a 90th percentile scenario for the average pore water concentration in the root zone. However, development of a scenario targeted to the concentration in the root zone will take time. When such scenarios are developed, they can be best targeted to the total mass taken up from the start of the growing season to the moment of flowering, because this is likely to be a better indicator of the concentration in nectar and pollen than the average pore water concentration in the root zone.

Once this average pore water concentration is available, the *PEC* in nectar and pollen can be calculated (box 5) and it can be checked whether this results in acceptable risk. If not, the spatial variation of the RUDs in nectar and pollen has to be assessed via field measurements (box 6); see [Appendix G](#) for guidance on how this should be done. These measurements are used to assess a higher-tier residue intake rate as described in Section 1 of this Appendix N.



**Figure N5:** Flow chart for the exposure assessments of the *PECs* for nectar and pollen in permanent crops in the year after one or more spray application(s). The box numbers refer to the general text above. See second paragraph of this appendix for the explanation of the rules of logic of the flow chart

Next, the risk assessment crops succeeding annual crops is presented (Figure N6). As described previously, both succeeding crops in the application year as well as succeeding crops in the next year are considered. The first step (box 1) is to calculate SVs assuming a default RUD of 1 mg/kg based on the default value proposed in the EPPO scheme (Alix and Lewis, 2010) and supported by pertinent data in Appendix F (data for seed treatments and granules). It has to be noted that the default 1 mg/kg suggested by EPPO is application rate independent (i.e. to be considered as *PEC* in pollen/nectar), although the residue trials which were considered to derive this value used the registered application regime of those pesticides (i.e. no extreme application regime were considered). Also, the residue trials reported in Appendix F, used realistic application rates and both the *PEC* values and the derived RUD values (application rate dependent) were below 1 mg/kg. Therefore it was considered that the default RUD of 1 mg/kg is a worst case value in combination even with a single application rate provided that the application regime is not an extreme (see later). However, for particular cases this approach may underestimate the risk therefore special attention is required for those cases (i.e. the

total annual application rate or accumulated PEC pore water should be considered, which may also consider crop interception). Those cases are when high application rates (e.g. some kg/ha) are combined with multiple applications specially for persistent active substances (in soil) or when persistent metabolites are formed. These uses, if exist, might indicate high risk in other areas of the risk assessment. It has to be noted that this approach is considered only as an interim solution and this assumption could be tested and results used for future improvement of this guidance for all areas where the default RUD of 1 mg/kg was used.

The next step (box 2) is to check whether the  $DegT_{50}$  in topsoil at 20 °C and at a moisture content at field capacity is low enough to prevent exposure. We propose a trigger of two days for succeeding crops in the application year and 5 days for crops grown the year after. These triggers should also be underpinned by scenario calculations for the full range of substance properties. The next step (box 3) is to check whether attractive succeeding crops occur for more than 10% of the area of use of the substance. If not, less than 10% of statistical population of the hives will be exposed via these types of plants and this exposure scenario can thus be ignored when assessing the 90th percentile exposure of the hives. If they do occur above 10%, then box 4 indicates that the 90th percentile of the average concentration in the pore water in the root zone at the start of flowering should be assessed.

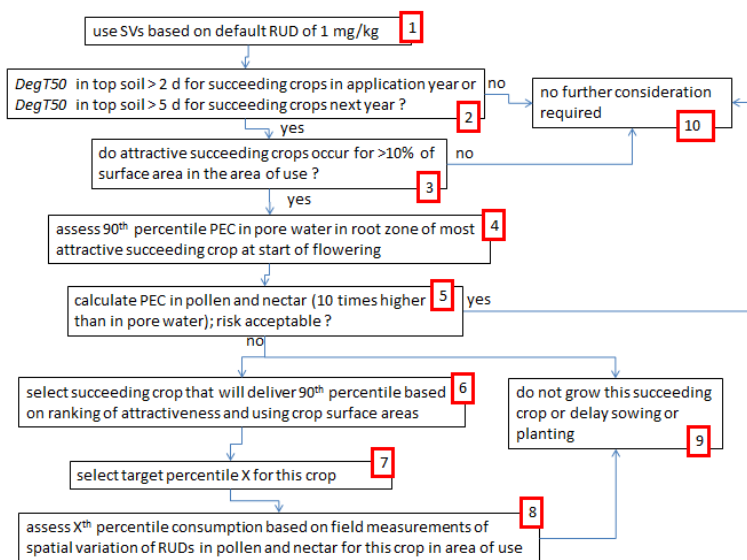
For the annual crops grown in the next year, we propose following the same approach as for the permanent crops, i.e., use the FOCUS groundwater scenario that is most relevant to the area of use of the substance. FOCUS (2009) parameterised scenarios for some twenty annual crops including, for example, oilseed rape. This should be considered as an interim approach, just as it is for the permanent crops (see previous paragraph for explanation). For the succeeding crops grown in the year of application of the substance, the FOCUS leaching scenarios seem less appropriate because leaching is a process of years, whereas the exposure of these crops has to be assessed, for example, three months after application of the substance (FOCUS, 2009). For these crops we recommend using the guidance developed by the EFSA Panel on Plant Protection Products and their Residues (PPR) (EFSA, 2012b) for assessment of the 90th percentile of the average pore water concentration in the top 20 cm of soil (in the context of the risk assessment for soil organisms).

In view of the above, we recommend developing targeted scenarios for assessing the plant uptake of substances in attractive permanent and annual succeeding crops and that these also be used to support selection of the combinations of soil and meteorological conditions that are likely to lead to the highest risk of carryover of residues to plants the following year.

The next step is box 5: calculation of concentrations in pollen and nectar by multiplying the pore water concentration by 10. If this does not lead to an acceptable risk, field measurements of concentrations in nectar and pollen are needed to assess the 90<sup>th</sup> percentile PEC. The spatial statistical population of hives consists of the hives at the edge of the treated fields (section 7.1). So the 90<sup>th</sup> percentile PEC in pollen and nectar should be assessed considering the frequency of all succeeding crops. Let us assume, for example, that there is only one attractive succeeding crop that occupies 30% of the area of use of the substance in the year after application. These 30% are now considered to be the upper 30% of the distribution of the PEC values. In such a case, the 90th percentile can be calculated as the 67<sup>th</sup> percentile of the frequency distribution of the measured PECs in nectar and pollen (because 90 is at 2/3 between 70 and 100; see Appendix I. for the general approach to calculate such a percentile). Thus we recommend selecting the succeeding crop that will deliver the 90th percentile, based on a ranking of the attractiveness of the succeeding crops in combination with their surface area in the area of use of the substance (box 6). Next the target percentile  $X$  for this attractive succeeding crop, corresponding to the overall 90<sup>th</sup> percentile, can be assessed (box 7; see Appendix I. for details) by measuring the spatial variation of the RUDs of nectar and pollen in field experiments (box 8). These measurements are used to assess a higher-tier residue intake rate as described in Section 1 of this Appendix, so the target percentile in this box refers to a percentile of the residue intake rate.

Should it be difficult to assess the spatial distribution of succeeding crops, the exposure assessment can of course always be simplified by using conservative assumptions (e.g. assessing the 90th percentile of the most attractive succeeding crop).

As indicated in Figure N6, there is also the risk mitigation option to not grow the succeeding crop that causes the problem or to delay sowing or planting of this crop until the soil residues have declined to an acceptable level (box 9).



**Figure N6:** Flow chart for the exposure assessments of the PECs for nectar and pollen in succeeding annual crops following one or more spray application(s) in the treated crop. The box numbers refer to the general text above. See second paragraph of this appendix for the explanation of the rules of logic of the flow chart

As indicated, the default RUD values in box 2 of Figure N5 and in box 1 of Figure N6 are based on expert judgement related to the levels of concentrations in pore water in the root zone at the start of flowering of the succeeding crop. It is advisable to check this expert judgement by calculations for the scenarios that are used in box 4 of Figures N5 and P6.

It is acknowledged that the information currently available to risk assessors is not sufficient to check box 3 and 6 in the flowchart above. This can only be implemented once harmonised scenarios are agreed for this type of assessment.

## 2.7. The likely hierarchy of the exposure assessments for the different types of plants in regulatory practice

Currently, the risk assessor must first perform the conservative screening step, and thereafter in the first tier go through all flow charts in parallel (Figure 5). It would be easier if we could define a hierarchy between these flow charts. However, the flow charts of Figures N1 to N6 are, in general, complex, and most of them contain options to reduce the exposure via risk mitigation. As described in Figure 5: , risk mitigation measures may lead to the need to go iteratively through some of the flow charts, because applying a risk mitigation measure may lead to another use of the substance. Nevertheless, below we attempt to shed some light on this hierarchy.

The assessments for the treated crop (Figure N1) and for crops grown after the treated crop (Figures N5 and N6) have no link to any of the other assessments and also have no link to each other. The

assessments for (i) the weeds in the treated field (Figure N2), (ii) the plants in the field margins (Figure N3), and (iii) adjacent crops (Figure N4) have in common that their exposure is based on the possibility that these plants flower at the time of application of the substance. So an option for a hierarchy could be to start with weeds in the treated field because they may receive the full dose (but not always: see box 4 of Figure N2), then to continue with the plants in field margins, where the deposition is usually less, and then to end with the adjacent crops.

The 90th percentile exposure PEC for the adjacent crops is likely to be lower than that for the field margins for two reasons. The first is that flowering attractive adjacent crops are present only at a fraction of the border of treated fields at the time of application whereas flowering plants in field margins may always be present at the time of application (it can be different only in the highly exceptional case that the adjacent crop would have much higher crop-specific RUD values than other field crops). The second reason is that the average concentration in the nectar and pollen in an attractive adjacent crop is lower than that in flowering plants in field margins because spray drift deposition decreases strongly with distance from the treated field. Thus, the exposure assessment for the adjacent crops is probably superfluous, since it will lead to lower exposure than for the field margins. However, the whole exposure assessment is based on the conservative assumption that all the foragers of a hive forage exclusively on the type of plant considered (see section 5.1.5). In the longer term, this conservative approach is likely to be replaced with a more realistic landscape-level exposure approach (see Appendix E.). It is possible that flowering of certain plant species in the field margin of a field may lead to lower hive exposure than, for example, an adjacent flowering oilseed rape crop, because the number of these plants in the field margin is much lower than the number of crop plants in the first few metres of the adjacent field. So the flow chart for the adjacent crops is likely to have little added value presently but will probably be important once landscape-level approaches have been developed.

### **3. Exposure assessment for solids**

#### **3.1. Introduction**

As described in section 5.1.8, the exposure assessment for solids is split into separate assessments for seed treatments and granules. The overview of the exposure assessment for seed treatments is described in section 5.1.8.2 and Figure 6: . The next section deals with the exposure assessments as required for the boxes 1, 2, 3 and 4 of Figure 6.

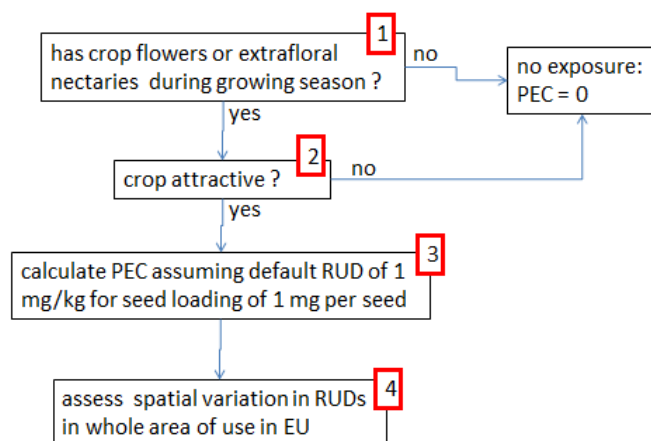
The overview of the exposure assessment for the granules is described in section 7.8.3. As indicated in this section, the scheme for spray applications (Figure 5) is used for the granules as well. So in this appendix, the exposure assessments for the boxes 2, 3, 4, 5 and 6 of Figure 5: are described considering granule applications.

#### **3.2. Exposure assessment for seed treatments**

##### **3.2.1. Concentrations in pollen and nectar in the treated crop after seed treatments**

The first two steps (boxes 1 and 2) in the exposure assessment for the treated crop are the same as for the spray applications - there is only exposure in the hive if the crop has attractive sources for nectar or pollen. See Appendix D. The next step is to use a conservative default value for the RUD from seed treatments (box 3). We propose using a RUD of 1 mg/kg, but assuming that this applies to a seed loading of 1 mg per seed. See Appendix F for background. It should be noted that this RUD is based only on data for four insecticides, of which three belong to the same chemical class (neonicotinoids). Therefore, a RUD of 1 mg/kg was selected which is on the conservative side in view of the data in Appendix F. Moreover, the EPPO guidance also used a value of 1 mg/kg (this value was not linked to the seed loading, but seed loadings are usually in the order of 1 mg per seed).

If this does not lead to an acceptable risk, the spatial variation of the RUDs could be assessed by residue analysis in five field studies in the area of use of the substance (i.e. in this case the whole cropped area in the EU) as described in [Appendix G](#).



**Figure N7:** Flow chart for the exposure assessments of the PECs for nectar and pollen in the treated crop after seed treatments. The box numbers refer to the general text above. See second paragraph of this appendix for the explanation of the rules of logic of the flow chart.

### 3.2.2. Concentrations in pollen and nectar in succeeding annual crops after seed treatments

After the growing cycle of the seed-treated crop, another attractive crop may be grown in the same year or in the next year. So it is possible that part of the substance brought into the soil with the seed will be taken up by succeeding annual crops, which may lead to problematic concentrations in pollen and nectar. We expect that this level of exposure will usually be small, because it can be expected that a large part of the substance brought into the soil with the treated seed will be taken up by the crop plant that grows from this seed, and because the remaining soil residue will probably behave as a slow-release formulation. In view of time constraints, we are unable to analyse the available relevant information in the literature and the dossiers in detail. Therefore, we propose assessing this exposure using the same flow chart as for spray applications (Figure N6), but using the whole surface area grown with this seed-treated crop in the EU as the basis for the assessment of the 90th spatial percentile (see section 5.1.8.1). The flow chart for the spray applications uses the groundwater scenarios developed by FOCUS (2009) and the soil exposure scenarios developed by the EFSA Panel on Plant Protection Products and their Residues (PPR) (2012b). However, these scenarios have been developed for spray applications and do not consider the processes resulting from application via seed. As described above, these scenarios probably overestimate the soil exposure resulting from seed treatments. As a consequence, the flow chart in Figure N6 may trigger field studies (in box 7) where they are not strictly necessary. Therefore, we recommend developing soil exposure scenarios for seed treatments analogous to the scenarios developed for spray applications by EFSA Panel on Plant Protection Products and their Residues (PPR) (2012b).

### 3.2.3. Concentrations in pollen and nectar in field margins after seed treatments

#### 3.2.3.1. Introduction

Just as for the other exposure scenarios, for the seed treatments we are interested in the average concentration in nectar and pollen in the whole field margin of the treated field, considering also the parts of the field margin that are not exposed because they were upwind during application.

As described before, field margins are exposed because of dust drift deposition. As described in Appendix H, the emission of the substance via dust is almost completely determined by technological factors (quality of the seed coating and the sowing equipment). Severe bee-killing incidents have been reported as the result of dust emission after sowing seeds pneumatically and considerable improvements have been achieved in recent years to reduce these emissions by using better equipment in a number of MSs (e.g. Germany); see EFSA Panel on Plant Protection Products and their Residues (PPR) (2012a). As described in section 5.1.8.1, the area of use of substances applied as seed treatments is the whole surface area in the EU where the crop whose seed is treated is grown. If we base the exposure assessment of a seed treatment on this total area, the 90th percentile case is likely to be a case with a type of sowing equipment with a comparatively high level of emission. This would have the consequence that one part of the EU cannot use a substance applied as a seed treatment because technological developments in another part of the EU are lagging behind. It is uncertain whether this is the intention of the SCoFAH. An alternative approach would be to link an authorisation at EU level to a certain class of sowing machines (similar to the classes for emission reduction of spray drift; see Huijsmans and van de Zande (2011)). These two approaches are fundamentally different: the first approach assesses the exposure based on the current reality of sowing equipment used across the EU, whereas the second approach prescribes the class of sowing equipment needed for a certain seed treatment (which would have the consequence that the use is considered not acceptable for classes of sowing equipment that generate more dust emission). We describe below exposure assessment methodologies for both approaches so that the SCoFAH can make an informed choice.

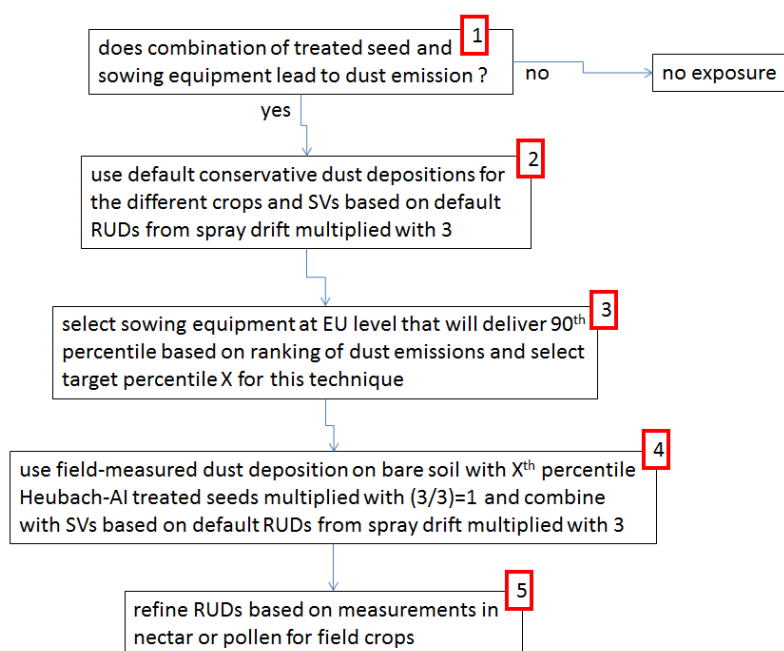
#### 3.2.3.2. Approach based on sowing equipment as used in reality in *the EU*

The first step of the exposure assessment (box 1 of Figure N8) is to check whether the combination of treated seed and sowing equipment will lead to dust emission (see Appendix C for detailed guidance). In the next step (box 2), the exposure is assessed using conservative default dust deposition figures combined with SVs based on default RUD values for pollen and nectar derived from spray applications and multiplied by a factor 3. The use of RUDs from sprays may seem strange at first, however, the background is as follows: Spray applications usually consist of spraying a liquid volume of no more than 300 L/ha; this is a water layer of 0.03 mm. Evaporation rates of water during daytime are in the order of 10 mm/day in Europe in spring and summer, so in the order of 0.5 mm/h. This means that the water of the spray application usually evaporates within a fraction of an hour. So a spray liquid will usually become a solid in the field in less than an hour. Therefore, it seems justified to assess the concentration in nectar and pollen based on RUDs from spray applications. However, the contact between deposited dust and the plants differs from that between deposited dry remnants of spray deposition and it is unknown how this influences the RUDs for nectar and pollen. For pollen there is the additional complication that the foragers may collect dust particles (assuming that they are pollen) whereas this is unlikely to occur with dried remnants of a spray solution. Therefore, we tentatively introduce a safety factor of 3. We recommend underpinning this in near future by analysing existing data on dust deposition and resulting concentrations in pollen and nectar reaching the hive.

We propose the following conservative default dust deposition (mass of substance per surface area of the adjacent field expressed as percentage of the mass of substance applied per surface area of treated field) to be used: 0.56% for maize, 0.22% for oilseed rape, 0.33% for cereals, 0.001% for sugar beets

and 0.56% for any other crop if pneumatic suction drills with deflectors is used; if such drills without deflectors is used these values are 10 times higher (see [Appendix H](#)).

The next step (box 3) is to assess the distribution of the different sowing equipment (mechanical sowing, pneumatic sowing with and without deflectors) across the EU. These have to be ranked in order of increasing dust emission and the percentage of the surface area of this crop that is sown with each type of equipment needs to be estimated (e.g. based on an EU-wide questionnaire). Then the sowing equipment must be selected that will deliver the 90<sup>th</sup> percentile dust emissions, assuming that only the sowing equipment determines the emission. For example, if the equipment with the highest deposition is used on 15% of the surface area, this equipment will deliver the 90<sup>th</sup> percentile. If the equipment with the highest deposition is used on 7% of the surface area, then this equipment will not deliver the 90<sup>th</sup> percentile and the equipment with the second highest deposition has to be considered. Furthermore, the target percentile X for this equipment needs to be assessed in box 3. Let us assume, for example, that 50% of cereals are sown mechanically and 50% pneumatically. The pneumatic equipment will lead to more deposition so this is the upper 50% of the frequency distribution. So taking the 80<sup>th</sup> percentile of the pneumatic exposure should then give the overall 90<sup>th</sup> percentile. This 80<sup>th</sup> percentile is the ‘target percentile X for this equipment’ as described in box 3. See [Appendix I](#) for the general calculation procedure of this target percentile.



**Figure N8:** Flow chart for the exposure assessments of the PECs for nectar and pollen in field margins after seed treatments based on the sowing equipment as used in reality across the EU. The box numbers refer to the general text above. See second paragraph of this appendix for the explanation of the rules of logic of the flow chart

So now we know now which percentile to assess considering all field margins adjacent to treated fields where this application equipment is used and we move to box 4. As described before, the dust emission is strongly driven by the mass of dust released in the Heubach test<sup>28</sup> and the concentration of active ingredient in this dust. We propose to combine these two factors by defining the ‘Heubach-AI’

<sup>28</sup> The Heubach method is used to assess the amount of free-floating dust and abrasion particles of treated seeds under defined mechanical stress conditions.

value as the mass of active ingredient per 100 kg seeds or 100000 seeds in the Heubach test. We propose to base the assessment of this Xth percentile on measurements of the cumulative frequency distribution of the Heubach-AI values, considering portions of seed sampled from the population of all seed treatment facilities for this crop-substance combination in the EU. Each seed treatment facility should be given a weight proportional to its production of these treated seeds within the EU. The assessment of this cumulative frequency distribution does not require that all seed treatment facilities should be sampled - the sample population should only be sufficiently large to assess the required percentile accurately enough.

The population of seed treatment facilities differs strongly for the different crops: e.g. in Germany there are about 15 such facilities for oilseed rape and about 1000 such facilities for cereals. Also, the variation in the Heubach-AI values is likely to differ strongly for the different crops. Taking again the example of Germany: the variation in Heubach-AI values for oilseed rape is likely to be much smaller than that for cereals because the 15 facilities for oilseed rape have agreed to work on the basis of the same protocol, whereas the ~1000 facilities for cereals have not yet done so. For the assessment of the 90th percentile exposure case this is not a problem: The assessment of the cumulative frequency distribution of Heubach-AI values by sampling the seed treatment facilities across the EU will take care of the current reality.

The above approach assumes that the sowing equipment has a much larger effect on the emission than the Heubach-AI value and that these are not correlated. They may be correlated if, for example, the sowing equipment with the highest emission is used in a certain region of the EU, the farmers in this region have a preference for seed treatment facilities in the same region, and if these facilities produce treated seeds with Heubach-AI values that differ systematically from the other facilities in the EU. Then this approach will lead to a systematic error in the estimated 90th percentile. Therefore, we recommend underpinning or refining the proposed approach by analysing relevant information in the literature and the dossiers.

Thus, based on Heubach-AI tests using seeds sampled from the relevant population of seed treatment facilities, a portion of treated seed can be identified that corresponds to the Xth percentile of the Heubach-AI value. We recommend as a next step (box 4) performing a field experiment in which the deposition of the substance on bare soil is measured as a function of the distance from the treated field using this portion of treated seed. For the field margin the target is the deposition over the first two metres, but measuring over at least 50 metres distance is recommended (to enable use of the data for the adjacent crop, as well). In such experiments the wind angle and wind speed have to be measured continuously (e.g. every minute) at different heights above the soil surface up to at least five metres. The wind angle during application should be within 30° of the line along which the collecting vessels for the dust deposition have been placed. If the angle appears to be larger at the end, the measured deposition should be corrected (no guidance yet available, so for the time being this correction can be ignored). Wind speed should be between 2 and 3 m/s. The background of this recommendation is that little is yet known about the effect of wind speed on dust deposition, in which case experiments can be best carried out at an intermediate wind speed. The deposition in the first hour after application should be measured. Also, the mass of active ingredient applied to the treated field should be carefully assessed.

The resulting deposition between zero and two metres distance from the treated field should be multiplied by 3 to account for the filtering capacity of the plants in the field margin and be divided by 3 to account for the overestimation of the average dust deposition because wind angle in the measurements is limited to 60° of the possible 360° (see [Appendix H](#)). As  $3/3 = 1$ , the resulting deposition can be directly used as the deposition in box 4 and it has to be combined with the default RUDs from spray drift multiplied by 3 (box 4); this is the same approach as was used in box 2.

If box 4 does not lead to an acceptable risk, we propose refining the RUDs of the plants by using RUDs measured for this substance on full flowering field crops in dust deposition experiments. This

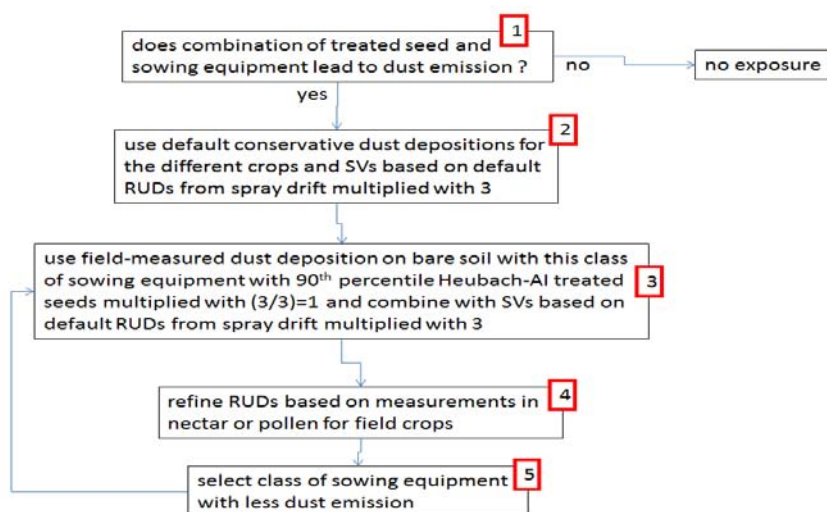
proposal is based on the assumption that the RUD of a substance is driven more by substance properties than by plant properties. This is likely to be the case, but it is uncertain whether this assumption can be extended to the full range of plants and substances. Therefore, we recommend underpinning this approach by analysing available data and further research. The alternative would be to measure RUDs for the most relevant plant species in the field margins; we do not advise this because the composition of attractive plants in field margins is likely to be very variable and we are not aware of data on this composition across the EU.

It is, of course, possible to add a risk mitigation box at the bottom of Figure N8 that says ‘exclude sowing equipment with highest dust emission’ with an arrow that goes back to box 3. This would be a compromise between the approach in this section and that in the next section.

### 3.2.3.2. Approach based on certain classes of sowing equipment

We now need to consider the alternative approach, i.e. linking an authorisation at EU level to a certain class of sowing machines. This is just a simplification of the approach in the previous section, because only one class of sowing equipment needs to be considered.

The first two boxes in the flow chart in Figure N9 are identical to those in Figure N8. In box 3, the same approach is used as in box 4 of Figure N8, with the simplification that a portion of treated seeds should be used that represents a 90th percentile Heubach-AI value. Box 4 is again identical to box 5 of Figure N8. If this class of sowing equipment results in unacceptable risks then there is a risk mitigation option to select a less problematic class of sowing equipment (box 5 in Figure N9) and to go back to box 3.



**Figure N9:** Flow chart for the exposure assessments of the PECs for nectar and pollen in field margins after seed treatments considering a certain class of sowing equipment. The box numbers refer to the general text above. See second paragraph of this appendix for the explanation of the rules of logic of the flow chart

The approach in Figure N9 is stricter than the compromise discussed at the end of the previous section because Figure N9 checks each class of sowing equipment separately whereas the compromise considers all classes of sowing equipment as one pool (e.g. not considering the worst class of equipment if this class was used for less than 10% of the treated fields).

### 3.2.4. Concentrations in pollen and nectar in adjacent crops after seed treatments

As in the other exposure scenarios, for seed treatments we are interested in the average concentration in nectar and pollen over the full width of the field of the adjacent crops.

For the assessment of the concentrations in pollen and nectar in adjacent crops the same choice as that for the field margins is possible, either base the assessment on the sowing equipment that are used in reality across the EU or base it on a certain class of sowing equipment.

We limit the assessment for the adjacent crops to the option of the equipment that are used in reality across the EU. The option of assessing a certain class of sowing equipment can be developed quickly in analogy to Figure N9 after the SCoFCAH has decided between the two options.

The first two steps (boxes 1 and 2 in Figure N10) are the same as in Figures N8 and N9, but note that the values for the conservative dust deposition in box 2 of Figure N10 differ: 0.27% for maize, 0.11% for oilseed rape, 0.16% for cereals, 0.0005% for sugar beets and 0.27% for other crops in case of pneumatic suction drills with deflectors and values that are 10 times higher for such drills without deflectors.

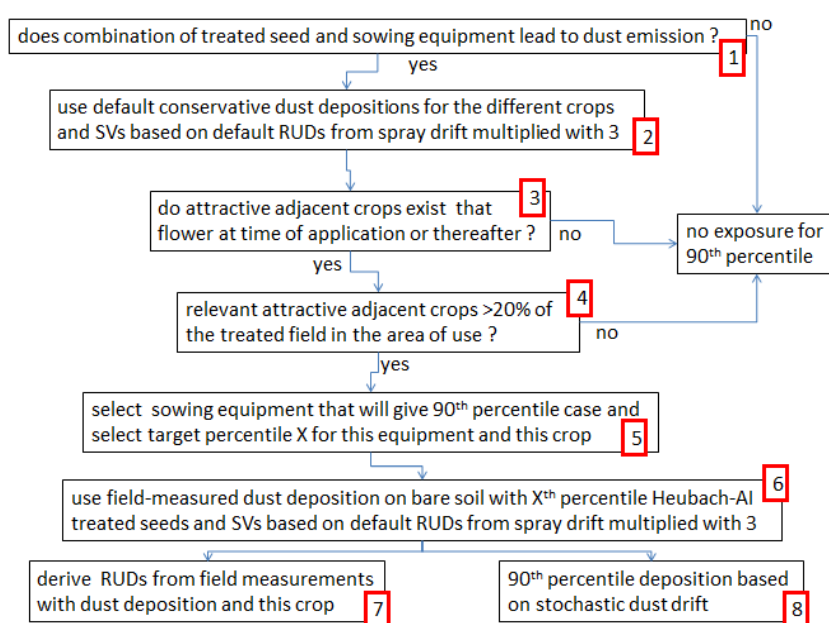
The next step (box 3) is to assess whether attractive adjacent crops exist that flower at the time of application or thereafter (otherwise the dust emission will not lead to exposure of hives). If more than one such crop exists, then it should be checked whether they will occur at the border of more than 20% of the treated fields (box 4). The background of the 20% is as follows: only 50% of adjacent crops will be exposed because 50% will be upwind during application so will receive no dust deposition. So if less than 20% of the treated fields have attractive adjacent crops, less than 10% of the hives at the edges of treated fields will be exposed via foraging in the adjacent crop. If this is the case, the exposure resulting from the adjacent crops can be ignored because this exposure will probably not influence the concentration for the 90th percentile of all hives at the edge of treated fields. Please note that this 20% is justified only because seed treatments are by definition applied only once per growing season. In the case of spray applications, which may be repeated many times in a growing season (especially in fruit crops), the statistics of the drift deposition are more complicated. Therefore, the limit in box 4 of Figure N4 (spray applications) was set to 10% whereas in box 4 of Figure N10 a figure of 20% is used.

In principle, it is possible (using crop maps available at EU level; see, for example, <http://eusoils.jrc.ec.europa.eu/library/Data/EFSA/>) to analyse the occurrence of attractive adjacent crops at zonal and member state level, statistically, and to use the results for all future risk assessments for seed treatments (thus making the use of this flow chart considerably easier and increasing harmonisation of these risk assessments at zonal and member state level). We therefore recommend that this exercise be carried out.

So after having passed box 4, we have one or more attractive crops that occur at the border in a total of more than 20% of the treated fields, and we must now assess the frequency distribution of the average concentration in nectar and pollen of the population of all these adjacent crop fields. The question is, which factors drive the variability of this frequency distribution? The main factors are likely to be (i) the sowing equipment and the Heubach-AI values of the treated seed (influencing emission), (ii) wind direction and wind speed (influencing deposition) and (iii) RUDs of the adjacent crop (influencing the relationship between deposition and concentration in nectar and pollen). The attractiveness of an adjacent crop does not influence the concentrations in nectar and pollen in this crop, so this is not considered here. However, this may become important at a later stage when the average concentration in the hive is assessed (using a landscape-level exposure assessment). Of these main factors, the sowing equipment, the Heubach-AI values and the RUDs do not depend on the weather at the moment of application. However, the wind speed and wind direction are of course influenced by the weather. Therefore, we propose assessing the effect of wind speed and wind direction differently from the other

factors, i.e. by stochastic modelling (Monte Carlo simulations), based on the natural variability of wind speed and wind direction; see Appendix H. for details.

We consider the sowing equipment to be the most important driver of nectar and pollen concentrations, so we start in box 5 by selecting the sowing equipment that will give the 90th percentile case. Furthermore, the target percentile  $X$  of this subpopulation of crop and sowing equipment is selected that will give the overall 90th percentile. The procedure is somewhat complicated so it is best explained via an example. Let us assume that there are attractive adjacent crops for 30 % of all treated fields and that there are two classes of sowing equipment, i.e. mechanical and pneumatic. Pneumatic gives the highest dust deposition and is used in 80% of the cases whereas mechanical is used in 20% of the cases. The first step is to divide the total percentage of adjacent crops by 2 because half of the fields are upwind during application. So we have 15% treated fields left, of which 12% are pneumatic and 3% are mechanic. So, of these 30% of the treated fields, 12% have the combination of a downwind attractive crop and pneumatic sowing. The target percentile  $X$  of this subpopulation is then  $100 \times (2/12) = 17$  because 2 of the 12% are below the 90<sup>th</sup> percentile. See Appendix I for the general calculation procedure for such percentiles.



**Figure N10:** Flow chart for the exposure assessments of the PECs for nectar and pollen in adjacent crops after seed treatments based on the sowing equipment as used in reality across the EU. The box numbers refer to the general text above. See second paragraph of this appendix for the explanation of the rules of logic of the flow chart

The next step (box 6) is the same step as in Figures N8 and N9, except that the target of the measurements is the average deposition between 0 and 50 m distance. No filtering factor for the crop needs to be used because the average deposition over 50 m is used (as explained in [Appendix H](#)).

After box 6, there are two final options. Box 7 requires RUDs measurements for the adjacent crop and dust deposition which can then replace the default RUDs. Box 8 allows for Monte Carlo simulations including the effects of wind speed and wind angle on dust deposition to assess the 90th percentile deposition case.

If certain steps in the flow chart are impossible due to a lack of available information, it is always an option to use a more conservative and more simple approach. For example, in case of the above example of 30% adjacent crop and 60% pneumatic equipment, it could have been assumed that 100%

of this adjacent crop occurs in combination with 100% pneumatic, which would give  $X = 80$  (because 50% of adjacent crops are upwind and have zero deposition) instead of  $X = 17$ , as in the above case.

### 3.3. Exposure assessment for granules

#### 3.3.1. Concentrations in pollen and nectar in the treated crop after granules application

For the assessment of the concentrations in pollen and nectar in the treated crop we propose using the flow chart in Figure N1 (designed for the spray applications). The only complication is the estimation of the default RUDs in box 3.

We propose the following procedure for box 3: If the granules are applied before emergence, the default RUDs are set to 1 mg/kg (for the application rate of 1 kg/ha), based on the measurements provided in Appendix F. for pollen residues from granule applications of clothianidin. This default conservative RUD of 1 mg/kg is further supported by the RUD values for seed treatments in Table F2 (which are all below 0.6 mg/kg), as it is considered unlikely that RUDs based on root uptake from granules would be considerably higher than RUDs based on root uptake from seed treatments. Additionally, the EPPO guidance also used a value of 1 mg/kg for seed treatments and soil applications. If granules are applied after emergence, the default RUDs from spray applications are used, but multiplied by 0.1 because less than 10% of the granules is expected to be dust, and multiplied by a safety factor of 3 because the RUDs are for spray deposition and are here used for dust deposition (so in the end multiplied by 0.3).

#### 3.3.2. Concentrations in pollen and nectar in weeds in the treated field after granules application

For the assessment of the concentrations in pollen and nectar in weeds in the treated field we propose using the flow chart from Figure N2 (designed for spray applications), but multiplying the default RUDs from spray by  $0.1 \times 3 = 0.3$  (0.1 because less than 10% of the granules is dust, and 3 because RUDs are for spray deposition and are here used for dust deposition).

#### 3.3.3. Concentrations in pollen and nectar in plants in field margins after granules application

As for the other exposure scenarios, for granular applications we are interested in the average concentration in nectar and pollen in the whole field margin of the treated field, thus also considering the parts of the field margin that are not exposed because they were upwind during application.

For the assessment of the concentrations in pollen and nectar in plants in field margins, we propose using a new flow chart (Figure N11) because the flow charts for the seed treatments (Figures N8 and P9) cannot be used without modifications. Unlike seed treatments, granule applications are not registered at the EU level. At the MS level it does not seem to make sense to assess 90<sup>th</sup> percentiles for different types of application equipment, so we will instead follow the same approach as in Figure N8, i.e. assessing the 90<sup>th</sup> percentile that will occur in agricultural reality.

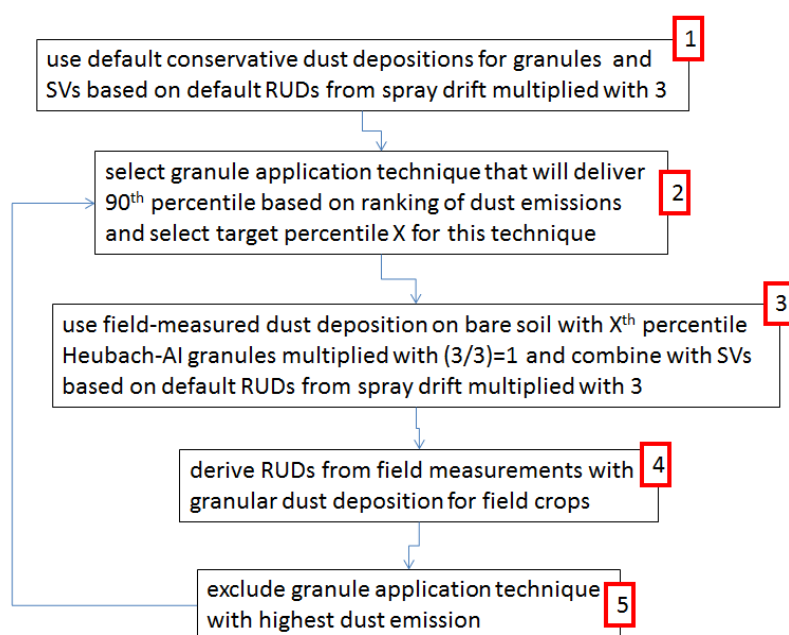
The first step (box 1) is to use default conservative dust depositions in combination with shortcut values (SVs) that are based on default RUDs from spray drift multiplied with 3 (because of the extrapolation from dust drift to spray drift). We propose setting the conservative default dust deposition to 3.2% (see [Appendix H](#)).

The next step (box 2) is to select the application technique that will deliver the 90th percentile dust deposition (similar to the approach in Figures N8 and N10). EFSA (2004) showed that a spinning disc will generate considerably less dust deposition than a boom spreader. So this implies that it is necessary to estimate what the percentage of the granule applications is with a spinning disc and with

a boom spreader. From this information, the target percentile,  $X$ , for this technique is then derived (see Appendix I. for details).

It is a point of debate which factor should be used to determine the percentile  $X$ . In principle, there are two candidates: the dustiness of the formulation and the meteorological conditions (wind speed). For the seed treatments, we proposed using the Heubach-AI value, considering the different seed treatment facilities in the area of use. EFSA (2004) sent a questionnaire to all MSs asking for the information on granule dust measurements that they require from notifiers. Twelve MSs responded and the conclusion was that there are no generally accepted criteria. So it is likely that there is considerable variation between the dustiness of different portions of granule formulation. Based on this we propose assessing the target percentile  $X$  on the basis of the Heubach-AI value of the granule. There is, of course, the problem that Heubach-AI values are not part of the current regulatory dossier. However, it may be possible to estimate the Heubach-AI values with the existing CIPAC (Collaborative International Pesticides Analytical Council) methods to measure the dustiness of granules (see EFSA, 2004, for a description of these methods). To bridge the gap between the Heubach test and the CIPAC methods, data are needed on Heubach-AI values for a range of granules for which the CIPAC information is already available. We recommend generating these data, as it may facilitate the introduction of this new approach in regulatory practice.

The next step (box 3) is to perform a field experiment on dust deposition on bare soil with a portion of granule formulation that approaches the  $X$ th percentile of the Heubach-AI values. The measured deposition between zero and two metres distance from the treated field has to be multiplied by 3 to account for the filtering capacity of the plants in the field margin, and to be divided by 3 to account for the overestimation of the average dust deposition because the wind angle in the measurements is limited to  $60^\circ$  of the possible  $360^\circ$  (Appendix H). As  $3/3 = 1$ , the resulting deposition can be directly used in this box and should be combined with default RUDs from spray drift multiplied by 3 as described before. The next step (box 4) is to refine the RUDs based on dust deposition experiments on field crops. If the risk is still unacceptable, it may be an option to mitigate the exposure by excluding the application technique that gives the highest deposition (box 5), and to go back to box 2.

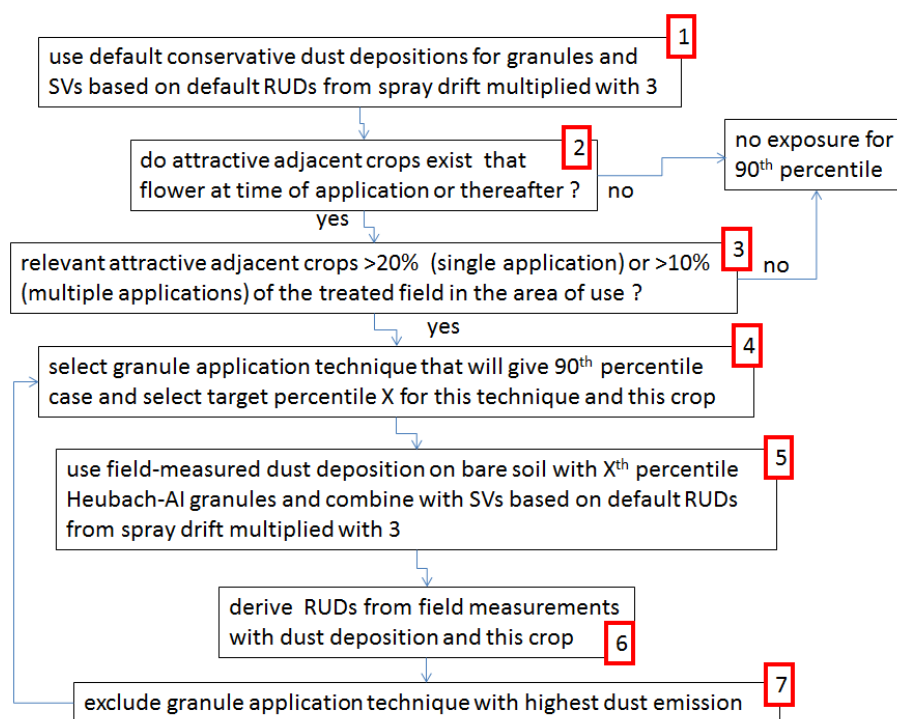


**Figure N11:** Flow chart for the exposure assessments of the PECs for nectar and pollen in field margins after granule applications. The box numbers refer to the general text above. See second paragraph of this appendix for the explanation of the rules of logic of the flow chart

### 3.3.4. Concentrations in pollen and nectar in adjacent crops after granular application

The assessment of the concentrations in pollen and nectar in adjacent crops can be performed following the same principles as for the spray applications and seed treatments (Figures N4 and N10). The flow chart in Figure N12 differs only slightly from that for the seed treatments in Figure N10, so only those parts that differ from Figure N10 are discussed here. Unlike Figure N10 there is no first box that checks whether the combination of granule and application equipment leads to dust emission because dust emission can never be excluded for granules. The conservative default dust deposition for granules in box 1 is 1.5% (as explained in [Appendix H](#)). The trigger percentage in box 3 is 20% for single applications and 10% for multiple applications because, unlike seed treatments, granule applications may occur several times in a growing season. The background of this 20% for single applications is the same as for the flow chart in Figure N10: only 50% of adjacent crops will be exposed because 50% will be upwind during application so will receive no dust deposition. So if less than 20% of the treated fields have attractive adjacent crops, less than 10% of the hives at the edges of treated fields will be exposed via foraging in the adjacent crop. If this is the case, the exposure resulting from the adjacent crops can be ignored because this exposure will probably not influence the concentration for the 90<sup>th</sup> percentile of all hives at the edge of treated fields. If there is more than one application, the statistics of the deposition are more complicated and the more strict 10% criterion is used in box 3.

Unlike Figure N10, Figure N12 contains a risk mitigation box at the bottom that allows for elimination of application techniques that lead to high risks.



**Figure N12:** Flow chart for the exposure assessments of the PECs for nectar and pollen in adjacent crops after granule applications. The box numbers refer to the general text above. See second paragraph of this appendix for the explanation of the rules of logic of the flow chart

### **3.3.5. Concentrations in pollen and nectar in permanent crops in the next year and in succeeding annual crops after granular application**

The assessment of the concentrations in pollen and nectar in permanent crops in the next year and in succeeding annual crops can be based on the flow charts for the spray applications (Figures N5 and N6).

#### **4. Recommendations for further work to improve or underpin the proposed exposure assessment guidance for concentrations of nectar and pollen entering the hive**

We recommend developing guidance for a landscape-level approach for the exposure of the average concentration in nectar and pollen entering the hive, because without such guidance the exposure assessment of this concentration is likely to be unnecessarily conservative. Such guidance has to be based on a quantitative model for assessing these concentrations, considering a variety of attractive crops within the foraging surface area. We recommend developing such a quantitative model (see Appendix E. for a first attempt), and underpinning this with extensive field calibrations. Special attention should be paid to the effect of differences in the attractiveness of different crops on the average concentration entering the hive, because this may influence the assessment of the 90<sup>th</sup> percentile in the case of different attractive adjacent crops.

We recommend developing guidance at the EU level for assessing whether a significant fraction of the surface area of treated fields is likely to be covered by attractive weeds for more than 10% of the area of use of substances. This guidance is likely to become a useful element of the exposure assessment of concentrations in nectar and pollen in weeds in treated fields.

We recommend analysing available data on RUDs in attractive weeds and crops resulting from spray applications to underpin the hypothesis that the RUD of a substance in attractive weeds can be predicted from the RUD of this substance in treated crops. If the available data are insufficient, we recommend performing research to test this hypothesis. This hypothesis offers a higher tier option for the exposure assessments of concentrations in nectar and pollen in weeds in (1) treated fields and (2) field margins. We also recommend performing research on the role and significance of flowering weeds for maintaining colonies of honey bees.

We recommend performing geostatistical analyses (using currently available crop maps, e.g. <http://eussoils.jrc.ec.europa.eu/library/Data/EFSA/>) to assess the likelihood of occurrence of attractive crops (1) grown adjacent to the treated crop and (2) grown in the treated field after the treated crop. We recommend summarising the results of these analyses in the form of user-friendly software that produces the frequency distributions of these attractive crops for all major crops at the MS and zonal level. We also recommend analysing the width of these adjacent fields and their geometry in relation to the treated field because these parameters have a large effect on the average deposition of spray drift on these adjacent fields.

We recommend performing (1) a geostatistical study to underpin or revise the proposed field margin width of two metres and to check to what extent all edges of the field are surrounded by field margins, (2) a modelling study in which the spray drift deposition onto field margins and onto adjacent fields with attractive crops is simulated as a function of a stochastic wind angle and a stochastic wind speed from which the 90<sup>th</sup> percentile spray deposition cases can be derived (see van der Zande et al. (2012) for an example of such a study for spray deposition on surface water). This modelling study should also consider the effect of repeated applications. Furthermore, we recommend analysing all spray drift data available in the EU to underpin the assumptions on which this modelling study should be based. We also recommend considering in this analysis the fact that the plants in field margins and of the adjacent crop may 'catch' more drift than bare soil.

We recommend developing targeted scenarios for assessing the plant uptake of substances in attractive permanent and attractive annual succeeding crops, because such scenarios may be useful for assessing the need for residue analyses in nectar and pollen in such crops. It is advisable to check whether the proposed triggers  $DegT_{50} < 5$  days and  $DegT_{50} < 2$  days (Figures N5 and N6) are appropriate after these scenarios have been developed.

In view of the large uncertainty in the average concentration in nectar and pollen entering the hive in higher tier experiments, we recommend measuring this concentration in future higher tier experiments.

We recommend analysing available data on residues in nectar and pollen resulting from root uptake to underpin that non-systemic substances are not transported to nectar and pollen in amounts that could become relevant for the risk assessment of bees.

We recommend performing research to underpin or revise the assumption that differences in RUD values between different adjacent crops play only a minor role in the assessment of the 90th percentile exposure concentration in nectar and pollen in adjacent crops (for both spray applications and solid applications).

We recommend analysing existing data on concentrations in nectar and pollen that result from exposure to dust deposition (originating both from seed treatments and granules) in order to assess to what extent these can be predicted on the basis of RUDs resulting from spray drift deposition multiplied by a factor of 3.

We recommend performing research to further underpin or refine the factor of 3 used to extrapolate dust deposition on bare soil to dust deposition on attractive plants in field margins, and research to underpin or revise the assumption that the average dust deposition on fields of flowering attractive adjacent crops can be based directly on the deposition on bare soil.

We recommend performing stochastic simulation studies using calibrated physical models in which the dust deposition on attractive adjacent crops is simulated as a function of wind speed and wind angle to obtain a less conservative (and thus more realistic) assessment of the 90th percentile deposition.

We recommend developing soil exposure scenarios for seed treatments analogous to the scenarios developed for spray applications by EFSA Panel on Plant Protection Products and their Residues (PPR) (2012b), in order to improve the exposure assessment for weeds in the treated field and for attractive crops grown after the treated-seed crop.

We recommend analysing relevant information in the literature and dossiers on the effect of sowing equipment and Heubach-AI values on emission of dust during sowing of treated seeds to underpin or reject the assumption that the sowing equipment (mechanical versus pneumatic, with and without deflectors) has a much larger effect than the Heubach-AI value.

We recommend measuring Heubach-AI values for a range of granules and trying to correlate these with information in the dossier on the dustiness of these granules (CIPAC methods).

We recommend collecting and analysing all available data on dust deposition of granules on plants in adjacent crops in order to underpin or reduce the default deposition values proposed in this guidance.

We recommend performing field experiments with attractive succeeding crops to check the assumption that the concentration in nectar and pollen is 10 times the concentration in the pore water in the root zone.

We recommend assessing, via field experiments, whether the uptake of substance by crop roots and its transport to nectar and pollen could be significant if the substance is sprayed before flowering and is not systemic.

We recommend performing simulations with numerical models to assess the 90th percentile PEC in pore water in the root zone, in order to check the worst-case upper limit of this PEC as used in box 2 of Figure N5 and box 1 of Figure N6

## Appendix O. EFFECTS STUDIES—PROTOCOLS, GUIDANCE AND GUIDELINES FOR HONEY BEE, BUMBLE BEE AND SOLITARY BEE

### PLEASE NOTE

In order to ensure that the regulatory risk assessment is sufficiently robust, it is conventional to only use internationally agreed and adopted guidelines in regulatory risk assessment. In using internationally agreed and adopted guidelines, it is assumed that the studies are sufficiently reliable, repeatable and reproducible. However, given the terms of reference and the need to develop a risk assessment it has been necessary to draft new or modify existing guidelines.

It is acknowledged that this is not desirable as the study design may not be ideal; however, they are considered appropriate until internationally agreed and adopted guidelines are available. It is proposed that the following draft guidelines should be used until such time that an internationally agreed and adopted guideline is available. All studies (including semi-field and field studies) should be conducted to good laboratory practice.

The above applies to studies on honey bees, bumble bees as well as solitary bees.

### Test protocols for honey bees

#### Effects studies on honey bees

##### Introduction

Outlined below are laboratory, semi-field and field studies for honey bees. As indicated above, not all of these studies are adopted; however, until such time that guidelines for larval toxicity and chronic toxicity to adult honey bees are adopted, it is recommended that the following are used. As regards the acute oral and contact toxicity studies, the OECD guidelines should be used, taking particular note regarding the need for observations of sublethal effects.

Please note that the acute contact toxicity study is only required when exposure to either spray deposits or dust is considered likely. For all other uses, there is no need to carry out a contact study. It should be noted that for all other uses or routes of exposure it is essential to have data on the acute oral toxicity to adults, chronic toxicity to adults, and toxicity to larvae as well as consideration of the potential accumulative effects.

As regards whether studies on the active substance or the formulation are required, the following is proposed:

Application method	Study with active substance required	Study with formulation required
<b>Spray</b>		
Acute oral	Yes—always required	Yes <sup>a</sup>
Acute contact	If exposure to spray deposits are likely then required.	If exposure to spray deposits are likely then required <sup>a</sup>
Chronic oral toxicity to adults	Yes	No <sup>b</sup>
Toxicity to larvae	Yes	No <sup>b</sup>
<b>Solid</b>		
Acute oral	Yes	No <sup>c</sup>
Acute contact	If exposure to spray deposits are likely then required.	No <sup>c</sup>

Application method	Study with active substance required	Study with formulation required
Chronic oral toxicity to adults	Yes	No <sup>c</sup>
Toxicity to larvae	Yes	No <sup>c</sup>

- a Acute studies with the formulation are required only if the toxicity cannot be predicted on the basis of the active substance.
- b Generally, a study with the active substance will be sufficient; however, if there is an indication from the acute oral study that the formulation is more toxic than the active substance, then the formulation should be tested. In determining whether there is a difference then the endpoints should be expressed in terms of active substance and if the formulation endpoint is more than a factor of 5<sup>29</sup> or greater then it can be assumed that the formulation is of greater toxicity and hence testing should be carried out using the formulation. If the formulation is less than a factor of 5 more toxic than the adult chronic toxicity and larval study should be carried out on the active substance.
- c No formulation testing is required for applications applied as solids as the carrier is usually an inert substance or of low toxicity compared to the active substance. If there is any evidence that the carrier is potentially toxic or could affect the toxicity profile, e.g. it is a slow-release formulation, then testing may be required and this should be considered on a case-by-case basis. If a second active substance is present this could be addressed by calculating the endpoint based on recommendations in chapter 8. If there is indication of synergistic effects then the formulation should be tested.

Subspecies of honey bees (= geographic races) potentially vary in their sensitivity or susceptibility to pesticides. Information is currently not available to clearly indicate which races are more or less sensitive to pesticides. Whilst it is not currently possible to make a recommendation regarding which subspecies of honey bee should be tested in terms of sensitivity to pesticides, it is recommended that the honey bees used for testing (i.e. field and laboratory studies) should be the prevalent subspecies for the MS and/or zone for which authorisation is being sought. In order to minimise variability it would be ideal if the same subspecies of honey bee was tested in the laboratory as well as the semi-field/field. However, it is acknowledged that, as the data package will be developed over time, this may not be practical. It is, therefore, recommended that for semi-field and field studies that the same sub-species of honey bee should be used, i.e. the subspecies of bee should not vary between replicates for semi-field and/or field studies. For laboratory studies, honey bees from the same queen should be used. In order to ensure adequate and accurate identification the way the race has been determined needs to be clearly stated.<sup>30</sup> Please note that this is in line with the OECD Guidelines 213 and 214 and OECD 75.

## Laboratory tests for honey bees

### Adult—acute oral and contact toxicity test

Acute oral and contact toxicity of the test compounds to adult honey worker bees are assessed in laboratory following OECD Guidelines 213 and 214. In these tests, bees are exposed to a single dose of the compound by feeding a contaminated sugar solution or by topical application. A suitable range and number of concentration should be used to provide a regression line and calculate the LD<sub>50</sub>.

It is important that the OECD guidelines are complied with in detail, and in particular it is important that note is taken of paragraph 20 of OECD 214 and that all sublethal effects are recorded. Any symptoms of intoxication observed should be recorded together with their duration, time of onset, severity and number of affected bees at each dosage level. Examples of neurotoxicity symptoms are uncoordinated movement, trembling, tumbling, hypo-/hyper-responsiveness and hypo-/hyperactivity, abnormal movements of legs or wings. Observations should be made as frequently as possible and it is suggested that once every four hours would be appropriate. Full details regarding the frequency and

<sup>29</sup> A factor of 5 is used to determine whether the difference is due to inter-study variability or increased toxicity. The factor is based on SANCO Sanco/10597/2003–rev. 7 final2 14 December 2005 (EC, 2005), which in turn references WHO/FAO (2002)

<sup>30</sup> Please see Meixner et al. (2013); Ruttner (1988)

duration of observation periods should be included in the final report. In addition, note should be made of the need to continue the observation period up to 96 hours if the mortality continues to rise.

In addition, the following variables need to be in line with the OECD guidelines and noted in the study report:

The age of the individuals tested, the nutritional and health status of colonies from which the bees were collected for testing, the subspecies of the bees, the temperature and the humidity during the test.

The endpoint from these studies should be (providing that the study has not been extended): LD<sub>50</sub> contact (µg/bees) and LD<sub>50</sub> oral (µg/bees) at 48 hours.

### Chronic oral toxicity test

It is acknowledged that this protocol is not agreed or adopted, however, it is considered to be the most appropriate available at the time of writing the Guidance Document. If a suitable study is agreed and adopted then that should be used in place of the following.

The chronic oral toxicity test is based on information from Decourtye et al. (2005), (Suchail et al., 2001), Thompson H. (Food and Environment Research Agency, personal communication, 2012) and (CEB, 2012).

*Experimental conditions:* Newly emerged honey bees should be used<sup>31</sup> as this will ensure that the age of the test bees is homogeneous. It will also assist in the manipulation of the bees as young bees tend to be easier to manipulate and hence do not require anaesthesia with CO<sub>2</sub>. Bees should be obtained from a single colony (see above) in order to provide a similar status regarding origin and health. Honey bees should be randomly divided in groups of at least 20 bees and kept in holding cages with a sucrose solution, water and pollen. During the test, pollen should be available throughout the study and renewed at least every two days and free of pesticide residues (or at least from an area free of pesticides). Alternatively, commercial protein supply can be used. Sucrose solution should be prepared using demineralised water and a final concentration of 500 g/L should be achieved.

The number of doses and replicates tested should meet the statistical requirements for determination of LC<sub>50</sub> with 95% confidence limits. A control with bees fed with untreated sucrose solution should be included in each test. During the test, the cages should be maintained in the incubator at 33 ± 2 °C and > 50 % relative humidity.

*Mode of treatment:* Each group of 20 honey bees should be offered a known weight of a given concentration (or controls as below) in sucrose solution (500 g/L) for 10 days, the dose being measured into the feeder each day (1–2 mL per cage). Every day the feeders should be removed and weighed and replaced with fresh feed so that bees have continuous (*ad libitum*) access to the treated feed throughout the study. The dose consumed is determined by comparison of the weight of the dose remaining in the feeders with the initial weight of the feeders and weight of a known volume of the test solutions. The individual daily consumption is corrected by the number of surviving bees.

*Data assessment and reporting:* The test is deemed to be valid if the mortality in the control group is less than 15%.<sup>32</sup> Observations of mortality should be recorded at daily intervals up to 10 days of

<sup>31</sup> It is recommended that bees should be fed pollen during the first 24 hours to ensure that their enzyme systems are properly developed.

<sup>32</sup> The criterion of 15% is taken from the acute toxicity study outlined in EPPO 170, this compares to the criteria of 10% from OECD213. It is acknowledged that the chronic study has not been fully developed and ring tested and hence achieving low control mortality may be problematic and hence this value should be reconsidered in light of experience.

exposure. As regards sublethal and behavioural effects, it is proposed that effects on the hypopharyngeal glands are determined. At the end of the chronic exposure period, 10 randomly sampled live honey bees from each cage are removed, cooled for a few minutes and then decapitated under a binocular stereomicroscope for the dissection of the HPGs. The HPG are located in the head of the nurse worker bees, and are the main organs responsible of royal jelly secretion (the main brood food). The development of the HPGs can be assessed either with a microscope by measuring the acini diameter after dissection as described by Gregorc and Bowen (1999), Skerl and Gregorc (2010) or Hatjina et al. (2013) or with the Bradford method measuring the total protein of the gland (Sagili et al., 2005)

The data are used to determine primarily the  $LC_{50}$  (mg/kg) and the NOEC (mg/kg); the endpoints should also be expressed in  $\mu\text{g}/\text{bee}/\text{day}$ . The data are also used to investigate whether there are any indications of accumulative effects (see below).

### Test for accumulative toxicity in oral dose administered to honey bees<sup>33</sup>

#### Background

In order to determine if an active substance has the potential for accumulative effects, i.e. whether an active substance has the same level of effect or response under two exposure regimes, then a modified chronic toxicity study as outlined above has to be carried out. The results of this study will indicate whether an active substance has accumulative effects, and if so then, according to the risk assessment scheme there is a need to consider the risks further. Please note that this study can be combined with the above chronic toxicity study, however if this is done then the number of test doses in the chronic study needs to be increased as the endpoint is the  $LC_{50}$  at 48h in the accumulative effect study and the  $LC_{50}$  at 10 days in the chronic study.

#### Principles of the test

Haber's law predicts the same level of response under two exposures that produce an equivalent constant toxic load, where toxic load is defined as the product of the environmental concentration and time. If  $L$  denotes the toxic load necessary to cause a given effect among exposed subjects,  $C$  is the exposure concentration and  $t$  is the exposure duration, then Haber's law is given by

$$C \times t = L \quad (O1)$$

When Eqn O1 applies, the effect shows 'first order time-dependence'.

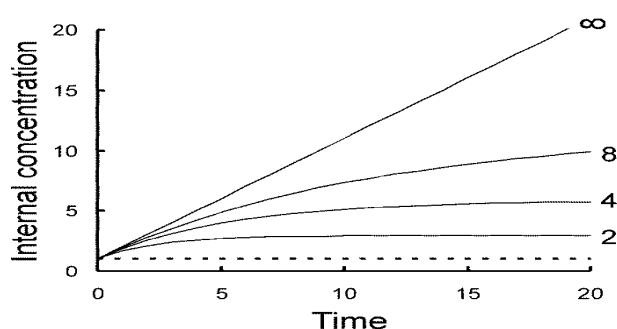
Assuming that daily consumption of syrup is constant and independent of the concentration of toxicant, an equivalent toxic load is produced by  $C_1 = LC_{50,48 \text{ h}}$  for  $t_1 = 2$  days and  $C_2 = 0.25(LC_{50,48 \text{ h}})$  for  $t_2 = 8$  days because the fourfold reduction in dietary concentration is compensated by the fourfold increase in the duration of the exposure. If the daily consumption rates of syrup are approximately equivalent, regardless of the concentration of the toxicant, then the total amount of toxicant consumed will be directly proportional to the duration of exposure and the use of  $Q_H$  and  $Q_L$  to test Haber's law simply involves a transformation of measurement units.

If, on the other hand, the toxicant is an anti-feedant, the consumption rates of syrup depend on the concentration of the toxicant and so the daily consumption rates may be higher in the cages exposed to the low concentration syrup ( $0.25 (LC_{50,48 \text{ h}})$ ). In this case, the cages exposed to low concentration

<sup>33</sup> It is recognised that the approach outlined to determine the potential for accumulative toxicity has not been ring tested, however it is considered an appropriate methodology. It is, however, acknowledged that there may alternative approaches to assessing potential accumulative effects and an applicant may use an alternative approach; however, it should be fully justified.

syrup manifest 50% mortality faster than expected simply through rapid consumption of the toxicant and  $t_2 < 8$  days is not due to accumulation. However, the test protocol has taken this into account. Toxic load has units of ‘molar hours’ because it is the product of concentration and exposure time and, in principle, it is proportional to the number of molecular contacts between the toxicant and its target site. For a perfectly non-accumulating toxicant, each molecule is eliminated instantly after contacting the target site and so the toxic load is equivalent to the total amount of toxicant ingested. Since an equivalent effect is expected from an equivalent toxic load, it is appropriate to test Haber’s law by comparing the total amount of toxicant consumed to bring about a fixed endpoint, such as 50 % mortality, between the two exposures.

For a persistent toxicant that accumulates during continuous ingestion, Haber’s law, as stated in Eqn O1, will fail to describe the exposure–concentration relationship because the concentration of the toxicant at its site of action increases with time even when the dietary concentration is constant (Figure O1).



**Figure O1:** Relationships between the internal concentration of a toxicant and time for five compounds with various degrees of persistence and accumulation.

Each curve relates to a hypothetical individual that ingests one unit of dietary toxicant per unit time but the five compounds vary in their biological half-life; one is eliminated completely by the end of each time unit (dashed horizontal line) and if the toxicant’s effects become disproportionately large as the duration of the exposure increases despite constant dietary concentration, the effect shows ‘second-order time dependence’, i.e. the toxic load necessary for a given level of fatalities is:

$$C \times t^b = L \quad (\text{O2})$$

where  $b > 1$ .

If we consider  $C_1 = LC_{50,48 \text{ h}}$  and  $t_1 = 2$  days, the exposure duration required to produce an equivalent toxic load  $C_2 = 0.25(LC_{50,48 \text{ h}})$  when  $b > 1$  is found by solving

$$C_1 \times 2^b = 0.25C_1 \times t_2^b \quad (\text{O3})$$

which yields

$$t_2 = \sqrt[b]{4 \times 2^b} = 2\sqrt[b]{4} \sqrt[b]{4 \times 2^b} = 2\sqrt[b]{4} \quad (\text{O4})$$

Note that this relationship does not depend on the concentration of active substance in the syrup used for the short exposure. For a non-accumulative toxicant ( $b = 1$ ), the required exposure duration is eight

days, as required. For an accumulative toxicant (e.g.  $b = 2$ ), the required exposure duration is less than four days.

### Testing protocol

Using information from the above chronic study determine the concentration that causes 50 % mortality after 48 hours. Denote this concentration (units of  $\mu\text{g/L}$ ) by  $\text{LC}_{50,48 \text{ h}}$ .

Using the same approach as outlined above for the chronic study, administer sucrose via a feeder at two concentrations of the compound:  $\text{LC}_{50,48 \text{ h}}$  and  $0.25\text{LC}_{50,48 \text{ h}}$  (which has a molarity of one-quarter that of  $\text{LC}_{50,48 \text{ h}}$ ). Sucrose consumption rates should be measured along with the daily mortality until each cage has accumulated 50% mortality. As stated above, fresh feed is replaced each day. Cages receiving sucrose of the lower concentration ( $0.25\text{LC}_{50,48 \text{ h}}$ ) are expected to reach this mortality in approximately eight days or fewer (see below). As regards the degree of replication see power requirements in step 4 below.

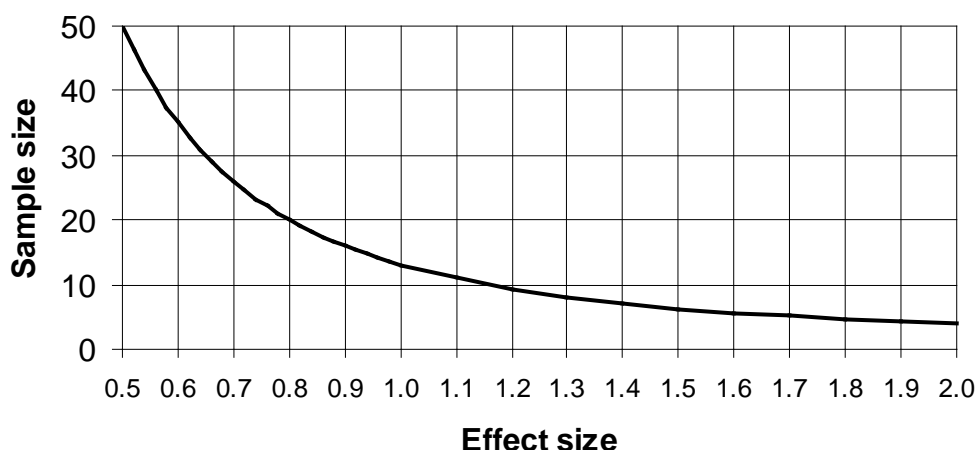
For each cage, determine the total (cumulative) quantity of test compound ( $\mu\text{g}$ ) consumed in each cage when 50 % mortality occurred. For a cage exposed to the high concentration ( $\text{LC}_{50,48\text{h}}$ ) treatment, denote this amount by  $Q_H$  and by  $Q_L$  for a cage at the low concentration ( $0.25\text{LC}_{50,48\text{h}}$ ).

For each separate concentration ( $\text{LC}_{50,48 \text{ h}}$  and  $0.25\text{LC}_{50,48 \text{ h}}$ ), determine the mean quantity of compound consumed (total) in each treatment group of cages, denoted as  $E(Q_H)$  and  $E(Q_L)$  respectively. If  $E(Q_L)$  is lower than  $E(Q_H)$ , there is potential for accumulation, so test the difference between these two means with an appropriate statistical analysis (e.g. one-tailed  $t$ -test if the assumptions are met). The experiment is valid if the power of the test to detect a 35 % difference in  $E(Q)$  between the two concentration treatments is at least 80 %.<sup>34</sup> This difference is calculated relative to the high concentration treatment: % difference =  $100 * [E(Q_H) - E(Q_L)]/E(Q_H)$ . A procedure for power analysis is given in Figure O2.

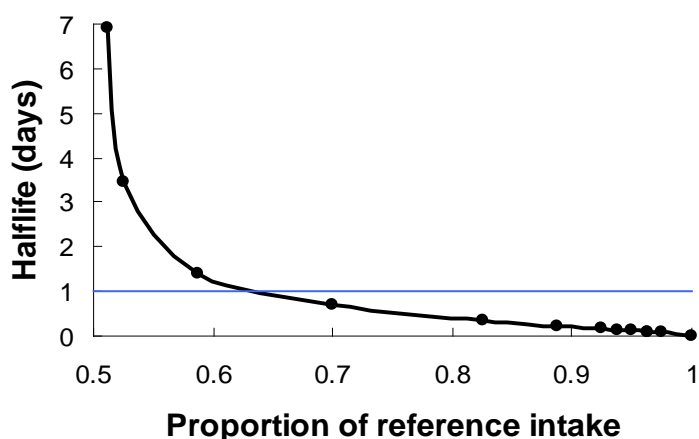
This value comes from Figure O3 and is the interception point between the half life curve and the day 1 (blue line) and is 0.65 (i.e.  $1-0.65=0.35$ ). This means that a difference of 35% between  $Q_H$  and  $Q_L$  can be estimated if we assume that the toxicant has an half life  $\geq 1$ .

Designate the active substance as showing a potential for accumulation if  $E(Q_L)$  is lower than  $E(Q_H)$  and the statistical test shows a significant difference between the two sets of  $Q_H$  and  $Q_L$  and the estimated half life of the toxicant is  $\geq 1$  day (calculate  $E(Q_L)/E(Q_H)$  and estimate the half life by using this value on the x-axis of Figure O3; the estimated half-life is the corresponding value on the y-axis). This threshold is chosen for the following reason: once an animal is no longer exposed to a toxicant, the expected time for the toxicant to be virtually eliminated from the animal's body is five time the toxicant's half-life because  $0.5^5 < 5\%$ . Five days is a significant proportion of an adult bee's lifespan.

<sup>34</sup> This value comes from Figure O3 and is the interception point between the half-life curve and the day 1 (blue line) and is 0.65 (i.e.  $1-0.65=0.35$ ). This means that a difference of 35% between  $Q_H$  and  $Q_L$  can be estimated if we assume that the toxicant has an half life  $\geq 1$ .



**Figure O2:** Sample size required to detect the size of a given effect using a one-tailed *t*-test with 80 % confidence, which is the conventional requirement for adequate statistical power. ‘Effect size’ is calculated as:  $E = (0.35 \times \text{mean measurement of control group}) / \text{standard deviation of control group}$ . Relationship obtained using `power.t.test (d = *, SD = 1, sig. level = 0.05, power = 0.8, type = ‘two.sample’, alternative = “one-sided”)` in **R** statistical software, where \* denotes the effect size (*E*).



**Figure O3:** Idealised relationship between estimated half-life and the observed total dietary intake of the compound in the low concentration exposure that precedes 50 % mortality as a proportion of the total intake in the high concentration exposure (i.e.  $\text{proportion of reference intake} = E(Q_L) / E(Q_H)$ ).

### Larval toxicity studies

It is proposed that a chronic larval toxicity study is carried out. This study should involve dosing of developing larvae throughout their life (except on day 2) with an assessment of survival and development at the end of pupation, pre-adult emergence.

It is acknowledged that no internationally agreed protocol or guideline is available and therefore the following is based on the draft OECD guideline for larval toxicity testing. The draft OECD guideline involves a single dose given on day 4. The study runs until day 7 and the endpoint is an LD<sub>50</sub> based on cumulative mortality. The study proposed for the risk assessment in chapters 3 and 8 is a repeat

feeding study that runs until day 7<sup>35</sup> with the endpoint (i.e. NOEC<sup>36</sup>) being the survival and development of larvae.

As regards the design and conduct of the study the draft test guideline on honey bee (*Apis mellifera*) larval test, single exposure should be consulted. The deviations from the draft guideline are as follows:

The larvae are fed once a day every day up to the start of pupation

Effects such as mortality of larvae, development (e.g. morphology and pre-pupal weight) and behaviour should be assessed and used to determine the NOEC in terms of µg/larvae (or equivalent—see footnote).

Please note for insect growth regulators, it is proposed that alternative testing is carried out and that this is discussed with the competent authority.

### **Semi-field and field tests for honey bees**

In order to ensure that the regulatory risk assessment is sufficiently robust, it is conventional to use internationally agreed and adopted guidelines in regulatory risk assessment. In using internationally agreed and adopted guidelines, it is assumed that the design of the studies are sufficiently reliable, repeatable and reproducible. However, given the terms of reference and the need to develop a risk assessment it has been necessary to develop and/or modify existing guidelines. This has been necessary to address concerns raised during the development of the risk assessment schemes. It is recognised that this is not desirable as the study design may not be ideal, however, they are considered appropriate until internationally agreed guidelines are available. It is proposed that the following draft guidelines should be used until such time that an internationally agreed and adopted guideline is available. All studies (including semi-field and field studies) should be conducted to good laboratory practice.

The key issue with higher tier studies is to ensure that the exposure is in line with the exposure assessment, i.e. the exposure in the effects field studies should be equal to or exceed the 90th percentile exposure estimate.

Outlined below is a very brief overview of the general approach; however, it is essential to read the relevant sections of the [chapter 7](#) and [Appendix N](#) when determining the exposure.

**In the higher tier exposure studies** different sets of exposure studies are needed depending on the exposure route which should be assessed.

#### **Contact exposure:**

When a potential risk is highlighted due to the risk of contact exposure, it is proposed that a non-toxic tracer is used in the field exposure studies. The residues on bees returning to the hive should be measured in order to indicate the contact exposure of foragers.

#### **Oral exposure:**

---

<sup>35</sup> Ideally this study should run until adult emergence; however, there is uncertainty regarding the feasibility of extending this study to include adult emergence. Therefore, it is proposed that this study should terminate at the end of pupation. Any adverse effects on pupae will be assumed to have prevented adult emergence.

<sup>36</sup> In line with the latest version of the data requirements under 1107/2009, when assessing the long-term/chronic/reproductive toxicity of an active substance the toxicological NOEC endpoint may be used; however, it is accepted that assessment using a toxicological effective concentration (EC<sub>x</sub>) endpoint is from a scientifically and statistically perspective more appropriate. Therefore, if possible an EC<sub>10</sub>, EC<sub>20</sub> and EC<sub>50</sub>, when required, along with corresponding 95 % confidence intervals. If an EC<sub>x</sub> approach is used, a NOEC should still be determined.

When a potential risk is highlighted owing to the oral route of exposure, then residues should be determined in plants (or bees foraging the treated crop) as well as bees returning to the hive. This will also give a measure of the dilution. If the dilution is large, then there needs to be a detailed consideration as to why this has occurred; for example, it may be due to a repellent effect of the active substance or it could be due to the selection of an inappropriate site where there is much alternative forage. If the latter is the case, then the study may be rejected. In situations where there is a large dilution and this is considered due to a repellent effect, then this should be substantiated by additional data or argumentation. It is not possible to give generic guidance on an appropriate level of dilution, hence each case should be considered on a case-by-case basis and expert judgement used to determine if a study is appropriate for risk assessment purposes.

Exposure studies for both contact and oral exposure should be conducted in five fields which are representative of the crop and the use of the compound. In order to prevent applicants choosing the best-case situations, the following criteria need to be fulfilled: no bee attractive crop should be present within two kilometres around the colonies and other alternative forager should be kept minimal (e.g. the presence of flowering weeds, trees and hedgerows should be minimal).

**In the higher tier effect studies** it is necessary to consider the following:

#### **Contact exposure:**

If an effect study is being carried out because of a potential risk from contact exposure (i.e. the HQ<sub>contact</sub> trigger has been breached), then the residues in bees in the field should be determined. This should include bees which are alive and foraging the treated crop as well as those that are dead. The latter may occur on the ground in the treated field or in dead bee traps.

The two datasets (i.e. live caught bees and dead bees) should initially be kept separate and a note made of how many dead/live bees were found and as well as their associated residues. The dataset should then be merged and compared with what was measured in the exposure studies. It should be noted that the overall exposure in the effects study must include the residues in dead bees as these bees are likely to have been the most exposed. The effect study should deliver also an accurate estimate of the forager mortality (see below) on each day and hence it should be possible to calculate the overall contact exposure of foragers.

#### **Oral exposure:**

If concern has been raised because of the oral route of exposure, e.g. the ETR<sub>acute</sub> adult trigger value has been breached, then it is essential to measure the residues in bees returning to the hive and compare these to residues in bees from the exposure field studies (see above). It is recommended that residues in plants (or bees foraging the treated crop) also be measured, as this will help to interpret the results and indicate the degree of dilution that may have occurred in the effect field study. It is important to only sample those bees returning to the colony and not those leaving the colony. The same procedure should be followed in the exposure field study.

It is essential that the effect field studies should be conducted in a worst case landscape to minimise dilution, i.e. no bee attractive crop within two kilometres of the treated crop and no flowering hedges or flowering trees within two kilometres of the colonies. No flowering weeds in the treated field and no flowering plants in field margins of the treated crop and adjacent crops.

If, as part of the initial risk assessment, there is a potential risk from both the oral and contact route of exposure, then it is still possible to conduct only one effect field study. It is necessary to measure residues in bees as outlined above, i.e. residues in bees in the field including dead bees to see whether the contact exposure was sufficient and residues in bees returning to the hive in order to see whether the oral exposure was sufficient (matching the exposure estimates or exceeding what was measured in

the exposure field studies). However, for the exposure assessment it is still necessary to have both sets of field residue studies (five fields with the tracer for contact exposure and 5 fields with the compound for oral exposure).

### Effects on larvae

If concern is raised only regarding the potential effects on larvae (i.e. only the ETRlarvae trigger value breached), then it *may* be possible to use either the Oomen method<sup>37</sup> or OECD 75 to refine the risk. However, if this route is used, it is essential that the exposure regime is in line with that outlined in the specific protection goal and the exposure chapter. Details of the ‘Oomen method’ are provided below. Details of OECD 75 are available from the OECD.

The ‘Oomen method’<sup>38; 39</sup>

The Oomen test is designed to investigate effects following oral exposure on bee brood. The endpoints are the mortality at seven days and just prior to emergence, together with assessments of brood deformities in pupae extracted just prior to emergence. This test may be run under semi-field or field conditions and permits an assessment of the effects after exposure to a defined concentration(s) of the test item in the sugar solution fed to bee colonies. It is possible to carry out the study using a range of concentrations and hence a dose–response can be achieved. Whichever approach is taken, it is essential to ensure that the exposure is in line with the SPGs (see [chapter 2](#)).

*Test procedure:* If a semi-field approach is taken, then the experimental design should follow the recommendations in the semi-field section. The number of doses and replicates tested should meet the statistical requirements for determination of a NOEC (or equivalent).

*Mode of treatment:* The test solution is made of sucrose solution<sup>40</sup> mixed with the test item and fed daily to the bees. A suitable toxic standard may be used. It is proposed that the selection of this should be determined on the basis of the mode of action of the compound being assessed. Feeding sucrose solution during the exposure period should be extended from a single dose feed on one day to feeding contaminated solution daily for 9 days to ensure that all larval stages are exposed. Usually test products are fed at a concentration recommended for a high-volume use.

*Data assessment and results:* The duration of the study should be at least 28 days after start of feeding (DAF) and first assessment of different brood stages to ensure all larval stages are assessed and that new eggs are laid into the cells after successful hatch of one brood cycle. Individual cells should be assessed on DAF +5 ± 1, DAF +10 ± 1, DAF +17 ± 1, DAF +22 ± 1, DAF +28 ± 1 (DAF 0: day of first feeding of the test item). Measurements of dead adult bees and dead bee larvae should be assessed daily using dead bee traps.

The development, the mortality of different brood stages and hatching success are assessed at regular intervals by assessment of brood development of all stages, egg, larvae, pupae. For this purpose at least 200 eggs, at least 200 young larvae and at least 200 old larvae should be assessed, preferably using

<sup>37</sup> Oomen P.A., De Ruliter A. and van der Steen J. (1992) Method for honey bee brood feeding tests with insect growth-regulating insecticides. Bulletin OEPP/EPPO Bulletin, 22 613–616 (1992). OECD 75: ENV/JM/MONO(2007)22 OECD Environment, Health and Safety Publications Series on Testing and Assessment No. 75 Guidance Document on the honey bee (*Apis mellifera* L.) brood test under semi-field conditions. Environment Directorate Organisation for Economic Co-operation and Development.

<sup>38</sup> Please note that that following is based on the Oomen study and is therefore, not totally in line with Oomen et al. (1992).

<sup>39</sup> As noted above, in order to ensure that the regulatory risk assessment is sufficiently robust, it is conventional to only use internationally agreed and adopted guidelines in regulatory risk assessment. In using internationally agreed and adopted guidelines, it is assumed that the studies are sufficiently reliable, repeatable and reproducible. Whilst this study has been used in the regulatory context, it has not been adopted and there are concerns regarding its use and interpretation within a regulatory context (see EFSA opinion).

<sup>40</sup> Sucrose solution should be in line with that used in the laboratory studies.

digital brood assessment. Larvae of different ages are considered desirable as effects different ages of larvae are required. The development of pupae should be assessed by extracting additional pupae on another comb, just prior to emergence to assess morphological abnormalities and weight of pupae. Although the implications of decreased pupal weight are not fully understood there are obvious implications of lower weights on fitness and longevity. Once before start of feeding (control) and at DAF+ 13 ± 1 for old larvae, DAF+ 15 ± 1 for young larvae and DAF +17 ± 1 for eggs, 50 pupae each should be taken for weighing from the test colonies. As pupae are removed at the last assessment for each stage (just prior to expected emergence) to determine morphological effects, the actual growth stage (from colour of the body and wing pads) and the weights of pupae should also be assessed to determine any adverse effects on development, e.g. delayed development.

## FIELD STUDIES

### BACKGROUND

Outlined below is guidance on how to determine the potential effects of a pesticide on honey bees under field conditions. The guidance is split into two parts, one for applications via spray and one for application of solids. If a field study is to be undertaken it is important to ensure that the exposure is appropriate. Details are provided below on how this should be determined. If adequate exposure is not achieved, the field study will be of limited use. Please see chapter 3 for guidance on how to determine appropriate exposure levels.

#### *Assessment endpoints*

There are two sets of assessment endpoints for field studies and these are as follows:

- **Primary assessment endpoints:** forager mortality, colony strength (number of bees), over-wintering success
- **Secondary assessment endpoints:** behavioural effects —including behaviour of foragers on flowers and returning to the colony, behaviour of guard bees at the colony entrance.

The primary assessment endpoints link directly to the SPGs outlined in [chapter 2](#).

Observations of the secondary assessment endpoints (behavioural effects) will be used to help explain any effects observed on the primary assessment endpoints. In the event that these observations suggest detrimental impacts, they cannot be used as the sole basis for a regulatory decision because effects on secondary endpoints do not in themselves threaten the SPGs. For example, if there is no effect on colony strength and/or overwintering survival or mortality, but there is an effect on foraging behaviour or foragers returning to the colony then this will not override an assessment's conclusion of 'acceptable risk' when based on a lack of effects on colony strength and overwintering success forager mortality. Conversely, if there is an effect on colony strength and an effect on the behaviour of foragers was noted, then this helps explain the effect seen.

In principle, the same concepts apply to both spray and solid applications, but some practical differences are better handled separately and so schemes for field studies of both modes of application are presented below.

## METHOD FOR APPLICATIONS VIA A SPRAY

### Assessment methodology for field study for applications applied via a spray

Outlined below are details regarding how the primary and secondary assessment endpoints can be determined. Please see above for explanation of primary and secondary assessment endpoints and their interpretation and use.

#### Study methodology for field study

##### Definition of terms

- **‘Field’**: a contiguous area of crop with a single chemical regime—either treated or untreated (control) with the pesticide, i.e. it is appropriate to refer to a ‘control field’.
- **‘Site’**: a location in the region for which the applicant seeks permission to use the pesticide. The site may include one or more fields, i.e. a site may include both control and treated fields.

#### Appropriate exposure

The key to achieving a valid study is ensuring adequate exposure. Please see section above and the relevant exposure flow charts regarding how to determine appropriate exposure.

#### Design of a field study

##### *Choice of crop*

The choice of crop that can be used for this study is up to the applicant. It may be possible to carry out this study with the proposed crop outlined on the label but it may also be possible to use a highly attractive model plant (e.g. *Phacelia tanacetifolia* or oilseed rape) and extrapolate the study findings to a range of crops. The key issue in selecting a suitable crop is to ensure that it is attractive to honey bees and that the residues, and hence the exposure to honey bees, is environmentally relevant and at least as high as predicted in the exposure section.

##### *Number of colonies*

The number of test and control colonies must be high enough to account for the normal inter-colony variability and allow statistical analyses.

Conventionally, a statistical test has adequate power when there is 80% confidence that the experiment detects an effect of the specified magnitude, if it exists. For example, roughly speaking, it requires treatment groups of  $n = 13$  to detect an effect whose magnitude is similar to the standard deviation of the individual measurements with 80% confidence in a one-sided Student’s *t*-test (i.e. when the treatment with the lower mean is specified in advance; one-sided tests are appropriate here because only the detrimental effect of the pesticide is sought).

The SPG requires the experiment to detect a  $> 7\%$  detrimental effect on colony size and it is reasonable to expect that the average colony will differ by at least about 7% from the mean value of colony strength in the control group (colony growth rate is likely to be a relatively noisy variable even when the initial colony size and quality is tightly controlled), which means that the standard deviation of the measurements is equivalent to the magnitude of the effect sought. It will be the applicant’s responsibility to show that the experiment had the required statistical power.

The sample size calculations below were done assuming a simple and robust experimental setting of beehives grouped by different sites. If additional confounding factors for the bee mortality are known, these should be included into the model as additional influencing factors to reduce the remaining variation between the beehives and finally the sample size needed. The development of more precise measurements for the bee mortality and an experimental setting which controls other confounding factors may be preferred than a larger number of beehives and sites.

To measure the effect ( $X$ ) of pesticides on a bee colony several measures are under discussion, e.g. the difference in the numbers of adult bees before and after application ( $X=\Delta A$ )/the difference in number of brood before and after application ( $X=\Delta B$ ).

We would assume a multiplicative effect, which can be transformed by the logarithmic function into an additive one:

Colonies without exposure:  $\ln(X_C) = \mu + \varepsilon$  (Control)

Colonies with pesticide exposure:  $\ln(X_E) = \mu + \rho + \varepsilon$  (Exposed)

- with:  $\mu$  Logarithmic mean effect in control group
- $\rho$  Logarithmic treatment effect
- $\varepsilon$  Stochastic error, assumed:  $\sim N(0, \sigma^2)$
- $\sigma^2$  Between colony variation (all other conditions are fixed)

In reality many other factors will influence the result and give additional variation  $\tau^2$ , these are the type and condition of the field, topography of the landscape etc. We would consider the mean effect as random:

$\mu$  Random mean effect, assumed:  $\sim N(v, \tau^2)$

The global model is therefore:

Colonies without exposure:  $\ln(X_C) = v + \varepsilon$  (Control)

Colonies with pesticide exposure:  $\ln(X_E) = v + \rho + \varepsilon$  (Exposed)

- with:  $v$  Logarithmic mean effect in control group
- $\rho$  Logarithmic treatment effect
- $\varepsilon$  Stochastic error, assumed:  $\sim N(0, \sigma^2 + \tau^2)$
- $\sigma^2 + \tau^2$  Total variation (between colonies and fields)

The regulatory condition should be justified for all fields and should be expressed in relation to the overall mean  $v$ :

$$E(X_C) = \exp(v) * \exp\left(\frac{1}{2}(\sigma^2 + \tau^2)\right)$$

$$E(X_E) = \exp(v) * \exp(\rho) * \exp\left(\frac{1}{2}(\sigma^2 + \tau^2)\right)$$

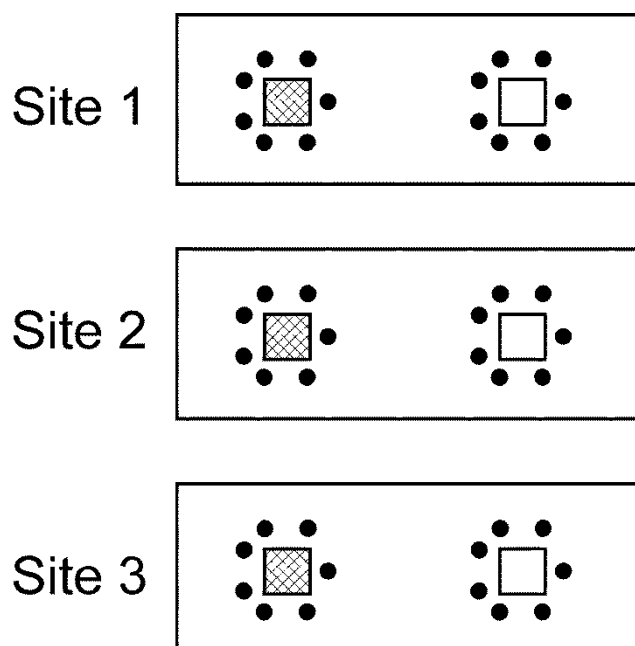
$$E(X_E)/E(X_C) = \exp(\rho) \geq 0.93$$

$$\Rightarrow \ln(E(X_E)/E(X_C)) = \rho \geq \ln(0.93) = -0.0726$$

To calculate the sample size to observe this difference we use a simple *t*-test on the logarithmic transformed observation (on independent samples of controls and treatment groups) and the approximation for the null hypothesis of no increase after treatment. To detect a decrease in colony size of at least 7 % the following approximate formula can be used.

$$N = \frac{2 \cdot (z_\alpha + z_\beta)^2}{\rho^2 / (\sigma^2 + \tau^2)}$$

- N Number of independent pairs of observations (treated and untreated fields)
- $\alpha$  Significance level of the *t*-test
- $z_\alpha$   $\alpha$ -quantile of standard normal distribution N(0,1)
- 1- $\beta$  Power of the *t*-test to observe minimal effect
- $z_\beta$   $\beta$ -quantile of standard normal distribution N(0,1)
- $\rho$  Logarithmic treatment effect
- $\sigma^2 + \tau^2$  Total variation (between colonies and fields)



**Figure O4:** Hypothetical design of experiment to test the effect of exposure to a pesticide on honey bee colonies. Each colony is denoted by ● Treated fields are shown crosshatched squares and untreated fields by open squares. The diagram does not show the exact locations of individual colonies

This implies that  $N$  pairs of fields should be tested to conclude on the effect. In reality several ( $n$ ) colonies will be used at only one (treated or untreated) field. This test design reduces the number of fields, but increases the total number of colonies needed to reach the requested power (Snijders 2005):

$$N = \frac{2 \cdot (z_{\alpha} + z_{\beta})^2 \cdot \left[ 1 + (n-1) \frac{\tau^2}{\sigma^2 + \tau^2} \right]}{n \cdot \rho^2 / (\sigma^2 + \tau^2)}$$

- $N$  Number of independent pairs of observations (treated and untreated fields)
- $\alpha$  Significance level of the t-test
- $z_{\alpha}$   $\alpha$ -quantile of standard normal distribution  $N(0,1)$
- $1 - \beta$  Power of the t-test to observe minimal effect
- $z_{\beta}$   $\beta$ -quantile of standard normal distribution  $N(0,1)$
- $\rho$  Logarithmic treatment effect
- $\sigma^2 + \tau^2$  Total variation (between colonies and fields)
- $\tau^2$  Variation between fields

$n$  Number of colonies per field

Given an example with a coefficient of variation between colonies of  $CV_H = 15\%$  ( $\Rightarrow \sigma^2 = \ln(CV_H^2 + 1) = 0.022$ ), between fields of  $CV_F = 5\%$  ( $\Rightarrow \tau^2 = 0.0025$ ) and a number of colonies per field of  $n = 7$ . The total number of pairs of fields is then  $N = 14$  (or 98 colonies per control / treatment in total). Would only one colony per field used in the experiment, then 60 pairs of fields (or colonies) are needed.

For the same input parameters (coefficient of variation) but an effect size of 50% (increase in forager mortality rate by a factor of  $1.5^{41}$ ) the number of fields is then  $N = 2$  (or 14 pairs of colonies in total).

These formulas give an approximation of the number of colonies needed to test the difference of effect size between control and treatment of 7% (colony size) and 50% (forager mortality) to significance level  $\alpha = 5\%$  and a power of  $\beta = 80\%$ . For a concrete study design, the calculation must be adjusted to the individual situation.

#### *Size of treated field*

In order to ensure appropriate exposure, the treated and control fields should each be at least two hectares in area and large enough to provide sufficient flowers to support exclusive foraging by the experimental colonies. In order to ensure that honey bees forage principally from the experimental fields, sources of nearby alternative forage should be sparse during the field test. It is acknowledged that this size cannot prevent foragers who do not visit the test field from bringing pollen and nectar from untreated flowers to the colony or from treated flowers with another pesticide in another field.

#### *Colony size and health*

At the beginning of the experiment, all colonies (treated and controls) must be in the same state (genetic origin (see introduction), population size, health status<sup>42</sup>). In order to ensure exposure of honey bees to the nectar and pollen from treated flowers, most of the frames containing food stocks should be removed from the colony before the beginning of the experiment to a level that just prevents starvation but allows sufficient stores for survival. It is acknowledged that this operation is difficult as it could cause a weakening of the colonies and it should only be conducted by experienced beekeepers.

All colonies should be of equal strength initially and then allocated to treatment (control, exposed) at random. Applicants should ensure that genetic variation is properly controlled. Ideally, the experimental colonies should initially comprise sister queens and identical numbers of adult workers taken from a common stock. To improve statistical power, steps should be taken wherever possible to minimise variation among colonies, including ensuring uniform initial colony composition before the colonies are allocated randomly between the control and treated fields at each site.

For testing a pesticide on a given crop, the most realistic conditions are to use colonies having the same level of development as the other colonies in this region at the time of year when they forage on that crop.

Generally, the size of a colony during the spring and summer seasons, is often between 20000 (spring) and 60000 or more (June to July) individuals, depending on the climate region. A colony of 10000 individuals corresponds to the beginning of its development at the end of the overwintering period in Europe when it starts rapid expansion in the early spring.

<sup>41</sup> It should be noted that the daily mortality rates are the average over a certain period of time, e.g. a factor of 1.5 is the average over six days.

<sup>42</sup> If treatment is needed to address disease or pest infestations, then the same treatment should be given to all colonies.

The colonies should be healthy at the beginning of the experiment, e.g. free of clinical signs of significant brood diseases and pests such as varroosis, nosemosis, amoebiosis, chalkbrood, sacbrood, American or European foulbrood) and at which the infestation level of *Varroa* is as low as possible. As most of the European colonies, even strong ones, contain infectious agents, it is not possible to use colonies that are completely free of them. Regarding the mite *Varroa destructor*, present in almost all European colonies, the level of infestation of the control and test colonies should be as low as possible. During and after the experiment, the health of the colonies should be evaluated for the whole range of bee diseases (including *Nosema*, *acarine* and the main viruses, e.g. through molecular screening).

#### *Number of sites and location of field*

The sites should be representative of the region(s) for which authorisation is sought. As regards location of the control and treated fields within a single site, it is recommended that they should be as similar as possible in terms of size and surrounding landscape.

The distance between the tested and the control colonies must be sufficient for preventing cross-foraging between treated and control plots. If there is an overlap in the foraging area of the control and tested colonies, the presence of significant residues in control colonies undermines the validity of the study and renders it of extremely limited value. In particular, if the control bees can forage in the treated field, the control colonies will be exposed and, conversely, the honey bees from the treated field could forage on the untreated crop and hence the resulting residue will be less than required by the exposure assessment. Information presented in EFSA Panel on Plant Protection Products and their Residues (PPR) (2012a) indicates that a distance of two to three kilometres between the treated and control colonies cannot fully guarantee the absence of an overlap between the foraging area of the control and tested colonies. Therefore, it is proposed to choose areas presenting similar environmental conditions, where possible at least four kilometres away apart. Whatever distance is selected, the exposure must be appropriate—see above and the relevant exposure flow charts for details.

At each site, that contains a pair of fields, the location of the control and treated fields should be decided at random.

#### *Duration of study*

The colonies used in the experiments (including controls) should be monitored for a time covering the entire flowering period and beyond. The study should assess at least two brood cycles (42 days) to ensure that a significant proportion of brood is exposed to residues stored within the colony.

In order to assess the primary assessment endpoint of overwintering success it is recommended that monitoring should be maintained for a time after the wintering period as contaminated honey and pollen stores could be consumed during winter (honey) and after the wintering period (honey and pollen). It is recommended that the colonies own honey should be used for the overwintering period. In addition, the treated and control colonies should be placed in an area far from fields in intensive agriculture in order to avoid a exposure to additional pesticides. All experimental colonies should be set up together at the same post-treatment location where no further pesticide exposure is expected (i.e. no flowering crops present), so that they are not exposed to different location-specific factors.

#### *Determination of exposure*

##### *Residue analyses*

These following analyses should have two goals: (1) to check that the bees from the treated fields have been exposed to the pesticide at the required concentration levels and (2) to check that the bees at the control fields have not been exposed to the pesticide from either the treated field or another one. If a biologically significant level of residues is detected in the flowers and/or colonies at a control field

then it is not appropriate to include that field in the risk assessment. All the residue analyses should be realised with the lowest possible LOD and LOQ.

In the higher tier effect studies it is necessary to consider the following:

### **Contact exposure:**

If an effect study is being carried out due to a potential risk from contact exposure (i.e. the HQcontact trigger has been breached), then the residues in bees in the field should be determined. This should include bees which are alive and foraging the treated crop as well as those that are dead. The latter may occur on the ground in the treated field or in dead bee traps. The time course of the concentrations has to be assessed as the concentrations are likely to be highest shortly after application and may decrease sharply immediately after application. Please see the relevant exposure flow chart for further details.

The two datasets (i.e. live caught bees and dead bees) should initially be kept separate and a note made of how many dead/live bees were found and as well as their associated residues. The dataset should then be merged and compared with what was measured in the exposure studies. It should be noted that the overall exposure in the effects study must include the residues in dead bees as these bees are likely to have been the most exposed. The effect study should also deliver an accurate estimate of the forager mortality (see below) on each day and hence it should be possible to calculate the overall contact exposure of foragers.

### **Oral exposure:**

If concern has been raised due to the oral route of exposure, e.g. the ETRacute adult trigger value has been breached, then it is essential to measure the residues in pollen and nectar in bees returning to the hive and compare to residues in bees from the exposure field studies. It is recommended to sample approximately 20 bees in triplicate on each sampling time (similar to the procedure proposed in Appendix G. ). The time course of the concentrations has to be assessed because these concentrations are likely to be highest shortly after application and may decrease sharply during the first week after application. It is recommended to measure also residues in plants (or bees foraging the treated crop) as this will help to interpret the results and indicate the degree of dilution that may have occurred in the effects field study. It is important to only sample those bees returning to the colony and not those leaving the colony.

If, as part of the initial risk assessment there is a potential risk from both the oral and contact route of exposure, then it is still possible to conduct only one effect field study. It is necessary to measure residues in bees as outlined above, i.e. residues in bees in the field including dead bees to see whether the contact exposure was sufficient and residues in bees returning to the hive in order to see whether the oral exposure was sufficient (matching the exposure estimates or exceeding what was measured in the exposure field studies).

### *Determination of effects*

As outlined above, effects fall in to two categories—primary assessment endpoints and secondary assessment endpoints.

The **primary assessment endpoint** of **colony strength** can be determined by using two complementary methods—the Liebefeld method (Imdorf et al., 1987) and weighing the colony. The two methods are complementary:

1. The Liebefeld method is a semi-quantitative method which can be used to determine major changes in the population of the colony. As it results in minimal disturbance of the colony, it can be used (with caution) during the experiment.

2. The method of measuring the weight of a colony is a quantitative method and is more accurate than the Liebefeld method. It is, however, more difficult to achieve. The protocol is described in Costa et al. (2012). As it disrupts the colony, it is recommended that it be used just before the start of the experiment and at the end of the experiment. It can accurately measure the change in weight of adult bees. Therefore, knowing the average weight of an adult bee (about 100 mg), it is possible to deduce the size of the population.

The Liebefeld method estimates the adult bee population and the amount of brood present in the colony. The adult bee population is assessed by visual estimation of the percentage of comb surface covered by bees. Each percentage value is then transformed into a number of bees according to the size of frame. In order to control some of the intrinsic variation among colonies, it is proposed to determine the number of adult bees at the beginning of the experiment and at the end of the exposure (after at least two brood cycles). A methodology for carrying this out is provided by Costa et al. (2012). It is proposed to use a similar approach to determine colony strength after the over-wintering period.

New methods are under development and it would be desirable to improve measurement of the primary endpoints (e.g. by weighing the hives which are placed permanently on a balance with an automatic reader).

The *primary assessment endpoint of mortality of foragers* needs to be determined. Unfortunately, there are no standardised reliable methods for determining this, however it is recommended to use radiofrequency identification (RFID) methods. A number of foragers should be tagged and their return to the colony determined. It is also recommended to label a sufficient number of emerging bees with for example colours or tags. These bees can then be followed during the course of the study. An assessment of the number of labelled foragers between the treated and the control colonies will give an evaluation of the survival of the foragers in the treated colonies. Alternative methods are available; however, they are not considered to be totally appropriate, e.g. dead bee traps, as they tend to measure dead bees at the colony (i.e. colony bees) and not foragers in the field.

The *primary assessment endpoint of over-wintering* should be assessed by comparing the colony strength of the treatment colonies with the control colonies. There should not be a significant difference between the control and the treatment.

As stated above, the secondary assessment endpoints are not linked directly to the SPGs. However, they can provide useful information that can help explain effects seen in the primary assessment endpoints. It should be noted that a statistically significant effect in a secondary assessment endpoint should not override effects seen (or not seen) in the primary assessment endpoints. For example, if there are no effects on colony strength and mortality of foragers, but there is an apparent effect on behaviour, then this should not override the lack of effects on the primary assessment endpoints. All results should be provided in the final study report.

The *secondary assessment endpoint of behavioural effects* can be determined using the following approaches:

The *behaviour of foragers* on flowers should be assessed both qualitatively and quantitatively. In order to determine the level of exposure of nectar and pollen foragers, the foragers should be counted on the test and control crops, at different times of the day, for a significant period of time, and throughout the experiment (see, for example, Karise et al. (2007)). The number of data collected should be sufficient to allow statistical treatment.<sup>43</sup> The behaviour of nectar and pollen foragers should be

---

<sup>43</sup> It is acknowledged that currently there is a lack of guidance on appropriate statistical techniques.

observed at least once a day. In particular, it is important to check that the honey bees are able to make the pollen pellet and to collect nectar.

In addition to behaviour on flowers, there should be a consideration of the following:

- **Presence signs:** this parameter refers mainly to motionless bees on the flower and to bees on the whole plant but not on the flower.
- **Cleaning signs:** observation and counting of the bees that clean themselves in two ways: (a) limited cleaning of legs and antennae and (b) overall cleaning (the whole body is brushed with middle or hind legs). These observations should be made for at least a few seconds and sometimes for several minutes for one bee.
- **Clinical intoxication signs:** Bees hang from leaves or from flowers by one or two legs. Sometimes bees are motionless, sometimes they clean themselves. Any such honey bee is supposed to fly away when pushed by the experimenter's finger and is counted as 'hanging bee'. When the bee falls and lies down, it is counted as a 'falling bee'. Paralysis and disordered wings or legs or disturbed movements—cramping or shaking bees, regurgitation stomach content.

### *Overall assessment*

In determining whether the pesticide/use combination poses an acceptable risk to honey bees, it is necessary to ensure that the exposure levels in-hive were appropriate, the number of replicates was sufficient and that any effect was in line with the protection goal (i.e. < 7% effect on colony size and/or mortality of foragers less than outlined in chapter 2 and Appendices A and B).

### **METHOD FOR APPLICATIONS FOR A PESTICIDE APPLIED VIA A SOLID**

A field study with a pesticide applied as a solid may be triggered for two reasons:

- the potential risk from deposition of dust on to adjacent crops/weeds and directly on foraging bees when they are flying over or near the sowed field, or
- the presence of the active substance in pollen and nectar of the treated crop, weeds, or adjacent crops.

The design of these field studies will be fundamentally the same as outlined above. It should be noted that from a regulatory perspective studies of this type are relatively rare and hence it is not possible to give very definitive guidance. It should also be noted that specific study and hence its' design is likely to be tailored to the risk highlighted at lower tiers. Therefore, in light of this, the following are key points that should be considered when designing such a study.

### **Exposure via dust**

If a risk from dust is predicted, then it is proposed that a study based on what is outlined above for sprays is conducted, however it is essential that the exposure is in line with the exposure estimates. For further information on how it may be possible to assess this see Georgiadis et al. (2012)

### **Exposure via the presence of the active substance in the pollen and nectar from a pesticide applied as a solid**

If a pesticide is applied as a solid (e.g. seed treatment or granule) and as a result residues in pollen and/or nectar reach levels that may cause harm, then the risk may be refined by the use of risk

mitigation measures (see chapter 11) and/or further experimental work. If the latter is chosen, then it will be important to ensure that the exposure profile in terms of levels and duration is considered; for example, in plants grown from treated seed residues may occur for the duration of flowering; hence bees will be exposed for many days, possibly weeks. In these circumstances, it may be appropriate to use the crop of concern rather than a model species, ensuring that the residues in pollen and nectar are at least as high as those predicted in chapter 7. As outlined above for applications made via a spray, it is essential to determine the exposure. It is proposed that a similar approach as outlined above for applications made via a spray is used for application applied as a solid.

### **Exposure via the presence of the active substance in guttation droplets from a pesticide applied as a solid**

The residues in guttation droplets represent a potential exposure route for bees. Specific test protocols in field conditions are required to assess the effects of guttation to honey bees if the risk is not acceptable in the first tier.

The basic study should follow the same study design as that outlined above for spray applications in terms of number of colonies, replicates, etc. As regards assessment endpoints, the same primary endpoints should be considered (i.e. colony strength and mortality). Secondary assessment endpoints should also be considered. Unlike in the assessment of the risk from uptake from residues in pollen and nectar, food should be provided via additional honey combs in the hives or sugar paste in case no forage is available during the test (e.g. in autumn). Permanent water sources should be located as far away as possible from the hives and test fields (e.g. the minimum distance between colony and water source should be at least equivalent to the 90<sup>th</sup> percentile distance to a water source in the proposed situation of use).

In carrying out the study, it is essential that guttation occurs and that the concentration is in line with that predicted in the exposure assessment. This is obviously difficult to do whilst the study is going on; therefore, site selection is key in determining the likelihood of guttation. The study should be carried out in the appropriate location (e.g. zone) and use the appropriate crop. It is likely that guttation will occur when the crop is emerging or very soon afterwards; however, preliminary studies may be required to determine the conditions (e.g. environmental conditions and relevant growth stage) under which guttation may occur. As outlined above, colonies should be placed at the edge of the treated fields in order to maximise the exposure to guttation. The study should run from emergence (if this is appropriate) of the crop for six weeks after emergence. Overwintering survival should be determined as outlined above.

## **SEMI-FIELD STUDIES**

### **BACKGROUND**

For field studies, the primary assessment endpoints are forager mortality, colony strength and overwintering success. These primary assessment endpoints are related to the SPG (see chapter 2). It is possible to determine effects on these primary assessment endpoints in a field study; however, this is not so straightforward in semi-field studies. It is accepted that there can be an assessment of forager mortality and hence it is possible to determine whether this is in line with the control. However, owing to the size of the colonies used and the duration of the study, it is not so straightforward to determine any potential effects on colony strength. Whilst, it may be possible to determine changes in colony strength as part of a semi-field study, it will not be possible to assess an impact on the development of the colony. This is due to the duration of the study as exposure will only be a few days and hence will not cover two brood cycles as in the field study. Similarly, due to the size of the colonies used, it is not possible to determine overwintering success. This is due in part to the fact that after the study the relatively small colonies will be placed in an area free of pesticide and could grow and hence mask any effects of the treatment. Because of these shortcomings, it is proposed that semi-field studies have a limited use in the risk assessment and decision-making process. It is accepted that semi-field studies

can provide useful information on certain issues, for example detailed observation of bee behaviour, forager mortality from contact exposure, and therefore can be considered supplemental in the risk assessment/decision-making process.

## METHOD FOR APPLICATIONS VIA A SPRAY

### Assessment methodology for semi-field study

#### Definition of terms

- **‘Plot’**: an area of crop with a single chemical regime—either treated or untreated (control) with the pesticide, i.e. it is appropriate to refer to a ‘control plot’.
- **‘Site’**: a location in the region for which the applicant seeks permission to use the pesticide. The site may include one or more plots, i.e. a site may include both control and treated plots.

#### Exposure

Key to any study is ensuring adequate exposure. As stated above, the semi-field study must be designed to ensure that residues will be at least as high as the predicted endpoint of the exposure assessment. In order to ensure adequate exposure, please see above as well as the relevant exposure flow charts.

#### Design of semi-field study

##### *Choice of crop*

The choice of crop that can be used for this study is up to the applicant. It may be possible to carry out this study with the proposed crop outlined on the label; alternatively, it may be possible to use a representative crop, e.g. *Phacelia tanacetifolia* or oilseed rape and extrapolate the findings to a range of crops. The key issue in selecting a suitable crop is to ensure that it is attractive to honey bees and that the residues, and hence the exposure to honey bees, is at least as high as predicted in the exposure section.

##### *Number of colonies and plots*

Each plot should have one colony. The number of test and control plots must be high enough to account for the normal inter-colony and inter-plot variability and allow for statistical analyses.

##### *Number of sites and location of plots*

The sites should be representative of the region(s) for which authorisation is sought. As regards location of the control and treated plots within a single site, it is recommended that they should be as similar as possible in terms of size and surrounding landscape.

At each site, the location of the control and treated plots should be decided at random.

**Please note that further work is required by the applicant to determine the number of plots required.**

##### *Size of plots*

In order to ensure appropriate exposure, the treated and control fields should each be  $> 60 \text{ m}^2$  and preferably  $> 80 \text{ m}^2$  in area, see below for further details.

##### *Colony size and health*

The use of small colonies is required in the semi-field methodology compared to field tests owing to limited forage area. Colonies should be of similar size and the strength should be adapted to the forage area but as large as possible. It is recommended to use colonies of at least 6000 adult bees and three to four brood combs (at least 15000 brood cells), containing a high amount of capped brood. It is noted that CEB recommends using colonies of between 10000 and 20000 bees and a surface area of between 120–160 m<sup>2</sup>. The study should start, if possible, early in the season. Major modifications of the colonies shortly before application should be avoided.

At the beginning of the experiment, all colonies (treatment and controls) must be in the same state (population size, health status). In order to reinforce the level of exposure of honey bees to the contaminated nectar and pollen, most of the frames containing food stocks should be removed from the colony before the beginning of the experiment to a level that just prevents starvation but allows sufficient stores for survival. It is acknowledged that this operation is difficult as it could cause a weakening of the colonies.

All colonies should be of equal strength initially and then allocated to treatment (control, exposed) at random. Applicants should ensure that genetic variation is properly controlled. Ideally, the experimental colonies should initially comprise sister queens and identical numbers of adults taken from a common stock. In practice, variation from this is allowable, but wherever possible uniform initial colony composition should be achieved among the colonies allocated between the control and treated fields at each site.

The colonies should be healthy at the beginning of the experiment, e.g. free of clinical signs of significant brood diseases such as American foul brood (AFB) and European foul brood (EFB). As most of the European colonies, even strong ones, contain infectious agents, it is not possible to use colonies that are completely free of them. Regarding the mite *Varroa destructor*, present in almost all European colonies, the level of infestation of the control and test colonies should be as low as possible. During and after the experiment, the health of the colonies should be evaluated for the whole range of bee diseases (including *Nosema*, *acarine* and the main viruses, e.g. through molecular screening).

#### *Duration of study*

Given, the supplemental nature of semi-field studies, the duration should be related to the rationale for conducting the study.

#### *Determination of exposure*

#### *Residue analyses*

Residue analyses must be performed on the nectar and pollen in the treated semi-field. If the study is being carried out to investigate the risk from contact exposure, then residues on bees should be determined. These analyses should have two goals: the first one, to check that the bees from the experimental colonies have been exposed to the pesticide, and the second one to check that the control bees have not been exposed to the pesticide of the treated plot or by another one, also present in the environment. If there are residues detected in the controls then the study is not valid. In addition, residues in nectar and pollen in the colonies should be determined. All the residue analyses should be realised with the lowest possible LOD and LOQ.

### **METHOD FOR APPLICATIONS FOR A PESTICIDE APPLIED VIA A SOLID**

The design of a semi-field studies with a pesticide applied as a solid will be fundamentally the same as outlined above, but will differ in the following respects:

#### **Exposure via dust**

If a risk from dust is predicted, then it is proposed that a semi-field study as outlined above for sprays is conducted; however,, it is essential that the exposure is in line with that determined in residue data from previously conducted studies (see Appendix J.). For further information on how it may be possible to assess this see Sgolastra et al. (2012b) and Georgiadis et al. (2012).

### **Exposure via the presence of the active substance in the pollen and nectar from the use of a solid formulation**

If a risk is predicted via this route, it may be appropriate to carry out a semi-field study to investigate certain issues. If this route is selected, it will be important to ensure that the exposure profile in terms of duration is considered; for example, in plants grown from treated seed residues may occur for the duration of flowering; hence bees will be exposed for many days and possibly weeks. In these circumstances, it may be appropriate to us the crop of concern, ensuring that the residues in pollen and nectar are at least as high as those predicted (see exposure flow charts in [chapter 7](#) for further information as well [Appendix N](#)).

## Appendix P. TEST PROTOCOLS FOR BUMBLE BEES (*BOMBUS TERRESTRIS*)

*Bombus terrestris* as key species in the risk assessment for bumble bees

The genus *Bombus* (family Apidae) comprises approximately 250 species and they are mainly distributed in the northern hemisphere with many more species and subgenera in Eurasia than in North America (Michener, 2007). *Bombus terrestris* is proposed as test species in the risk assessment scheme for bumble bees for the following reasons:

1. This species is commercially reared for the pollination of agricultural and horticultural crops in Europe.
2. Several toxicological studies are available in literature on this species and some protocols are already suitable for inclusion in the risk assessment (see EFSA Panel on Plant Protection Products and their Residues (PPR) (2012a) for a full list of references).
3. There are very limited data for bumble bee species other than *B. terrestris* although the data available show similar level of sensitivity when compared to *Apis mellifera* (Thompson, 2001; Arena and Sgolastra, *in prep.*).

At the moment official test protocols are not available for bumble bees. In this section the methods from literature to test compounds on *Bombus* spp. are proposed in outline (see EFSA Panel on Plant Protection Products and their Residues (PPR) 2012a), for the full list of references) but they have to be fully developed and validated by ring-testing.

### LABORATORY TESTS

#### Acute oral toxicity test (adults)

The acute oral toxicity test is designed to establish the oral LD<sub>50</sub> (median lethal dose) value, i.e. the dose, expressed in µg of active substance per bee, inducing 50% mortality following oral exposure of measured amounts of active ingredients or commercial pesticide formulations.

In the oral toxicity test for *Apis mellifera* (EPPO 170 and OECD 213) a common feeder is provided to a group of workers assuming that, through trophallaxis, all individuals will receive similar doses of test solution. However, bumble bees do not show trophallaxis behaviour and thus individual feeding is required.

*Test procedure:* For the laboratory toxicity test it is recommended that worker bees of average size and ages be collected. There is a significant link between the size of the bumble bee and its susceptibility to a pesticide. The bigger the bumble bee, the less susceptible it is to a pesticide; therefore, overly small and overly big bumble bees must be excluded from a test group (van der Steen et al., 2001). The test should be conducted with bees taken from young colonies. The use of recently emerged bees, recognisable by their greyish fur, should be avoided. At least 30 bees individually caged per dose should be used and kept in dark conditions at 25±2°C during the test. Bumble bees should be starved for about two to three hours before dosing.

For each test product, five concentrations are selected so as to range from 10 to 100% mortality with no more than twofold dilutions between doses. A control of bees fed with only sugar solution should be included in each test. A reference compound (e.g. dimethoate), should be used as toxic standard. After a single exposure to the test solution (see mode of treatment), bumble bees should be housed together by dose and sucrose should be fed *ad libitum*. An acute oral LD<sub>50</sub> consists of two replicates in time, preceded by a range-finding test.

*Mode of treatment:* Bees should be individually fed 10 µL of test solution dissolved in 50% sucrose solution using an individual feeder and a two-hour dosing period (see Van der Steen et al. (1996) and Marletto et al. (2003) for details of artificial feeders).

*Data assessment and reporting:* After dosing, mortality and sugar solution consumption should be checked daily (and corrected for evaporation). The LD<sub>50</sub> values (µg/bee) at 48 hours (providing that the study has not been extended because the mortality continues to rise) from exposure with 95 % confidence limits have to be determined using Probit analysis. The test is valid if the mortality in control is ≤10%. As for the honey bees, any symptoms of intoxication observed in bees during laboratory toxicological tests should be recorded together with their duration, time of onset, severity and number of affected bees at each dosage level.

### **Acute contact toxicity test (adults)**

The OECD 214 protocol for contact toxicity test in *A. mellifera* can be easily applied to bumble bees or other species of bees. The endpoint of this test is the contact LD<sub>50</sub> (µg/bee) following topical exposure.

*Test procedure:* As outlined for the acute oral toxicity test.

*Mode of treatment:* Bees are anaesthetised (by carbon dioxide, for example) for as short a time as possible until they stopped moving. One microlitre of test solution is then pipetted onto the ventral part of thorax between the second and third pairs of legs.

The test solution is prepared by dissolving each compound in acetone. A negative control with acetone and a positive one with dimethoate are also recommended.

*Data assessment and reporting:* As outlined for the acute oral toxicity test.

### **Chronic oral toxicity test, accumulative study and larval toxicity studies**

For the chronic and the larvae toxicity tests and for the assessment of the accumulative effect, it is proposed that the endpoints obtained in the tests carried out with honey bees should be used until an internationally agreed and adopted guideline is available for these tests.

### **Test with queenless microcolonies in the laboratory**

It is recommended that this study be conducted as a second step of the risk assessment when either an HQ or an ETR is breached or the active substance indicates the potential for accumulative effects. In this test, queenless microcolonies of worker bumble bees, *Bombus terrestris*, are exposed to different concentrations of the test compound (in order to calculate the NOEC) or at the concentration expected in the field. The use of microcolonies in the risk assessment studies with bumble bees can be justified by the low cost, the ease of use, and the possibility to work with several replicates in standardised conditions. This test allows the evaluation of effects of an active compound on worker mortality, normal larval development, feeding activity, fecundity (total number of eggs), and drone production. In this section it is proposed a protocol for long chronic oral exposure adapted from Mommaerts et al. (2010) and Laycock et al. (2012).

*Test procedure:* the study is performed with worker bumble bees under standardised laboratory conditions of 28–30°C and 60–65% relative humidity and continuous darkness. The insects should be fed *ad libitum* with sugar solution and commercial pollen as energy and protein source, respectively. Newly emerged workers should be collected from the bumble bee colony and five workers should be placed in an artificial nest box (i.e. 15 cm × 15 cm × 10 cm). In each nest box a worker will normally become dominant and begin to lay the eggs within a week, playing the role of a ‘false’ queen (the eggs

produced are only male progeny as the false queen is not inseminated). The four other workers help the false queen for brood care, which mainly consists in feeding larvae, building and heating cells.

*Mode of treatment:* In the experiment, the adult workers should be exposed orally to the test compound via syrup feeders over a period up to 60 days, or bees can be fed with the contaminated syrup for a shorter period, after which they are then provided days with untreated food until the end of the test (test duration: 60 days). The duration of the exposure is chosen to reflect the environmentally relevant period of exposure, which depends on the persistence of the compound in pollen and/or nectar.

The concentrations tested should be based on the effects at the first tier and should also encompass what is expected in the field (see [chapter 7](#)).

In the control nests, workers were exposed with untreated sugar solution. For each concentration, at least four artificial nests, each containing five worker bees, should be used. Each experiment should be repeated twice using different colonies as a source of workers.

It is proposed that in order to assess the impact of sublethal concentrations on the foraging behaviour on bumble bees under laboratory conditions, the experimental setup should consist of two artificial boxes connected with a tube of about 20 cm. Queenless microcolonies of five workers should be used. One box is used as a nesting area where the worker bees rear the brood, the other box is used for the food (sugar and pollen). Before exposure (for two days), the worker bees are allowed a training to forage for untreated food; afterwards this is replaced by treated food.

*Data assessment and reporting:* In the artificial nest boxes, worker survival should be evaluated daily for the first three days post treatment and then on a weekly basis for a period. The adverse sub lethal effects on reproduction should be monitored on a weekly basis for 60 days by scoring the numbers of offspring (total number of eggs, larval brood and adults) and/or drones produced per nest. These data can be used to calculate the NOEC in the event that bumble bees are exposed to a range of different concentrations.

## SEMI-FIELD TESTS

Semi-field tests are higher tier studies conducted in field cages/tunnels or greenhouse cages or glasshouse compartments and may be triggered as a result of possible concerns raised during the risk assessment. By far the majority of higher tier studies in bumble bees have been conducted in the glasshouse due to the widespread use of bumble bees for pollination. At the moment there are no formalised guidelines and the number of such studies are limited (see EFSA Panel on Plant Protection Products and their Residues (PPR) 2012a), for the full list of references or review in van der Steen (2001). However, the OECD semi-field honey bee methodology under insect-proof tunnels can be easily adapted to bumble bees.

In this section, a protocol based on the method of Tasei et al. (1993) is proposed.

*Test procedure:* At least three queenright bumble bee colonies (containing one queen, workers and brood sufficient to detect the required effect) are placed in a tunnel compartment (at least 42 m<sup>2</sup>) containing flowering plants. *Phacelia tanacetifolia* plants should be used as crop. The tunnel design should be at least 7 metres × 18 metres divided in three replicates of 7 metres × 6 metres with partitions. The number of replicates must be high enough to account for the normal inter-colony variability and allow statistical analyses with adequate power of the test.

*Mode of treatment and exposure:* The crop is sprayed with the pesticide. The key issue with either semi-field or field studies is to ensure that the exposure is in line with the exposure assessment, i.e. the

exposure in these field studies should be equal to or exceed the 90th percentile exposure case. The exposure should be determined according to the chapter 7 and associated flow charts.

*Data assessment and reporting:* Assessment endpoints can be similar to those used in semi-field trials of honey bees and may include adult and larval mortality, colony strength, amount of brood and foraging activity. An important endpoint that it is recommended be include dis the queen production.

### COMBINED FIELD-TO-LABORATORY STUDIES

This test may be carried out instead of a semi-field study or when concerns are raised from the chronic toxicity study in the second tiers (test with queenless microcolonies in the laboratory). Bumble bee colony development and reproductive output can be studied with the protocols proposed by Whitehorn et al. (2012) and Gill et al. (2012). In these tests, it is possible to manipulate the level of exposure because it takes place in controlled laboratory conditions, while the development of the colony takes place freely in field conditions. In Whitehorn et al. (2012), colonies of *Bombus terrestris* were kept in laboratory for two weeks and fed pollen and sugar solution *ad libitum*. Treated colonies are exposed to pollen and sugar containing the field-level pesticide concentrations. Controls are provided untreated pollen and sugar water. After two weeks of exposure in the laboratory, the colonies are placed in the field and their development is monitored for six weeks. In Gill et al. (2012), bumble bee colonies (*Bombus terrestris*) were housed in two chambered nest boxes: one chamber used for the nest and one used for two-phase pesticide exposure. The food chamber contains a feeder with a dose of the test compound in sucrose solution (or pesticide-free in the control) and the feeder is placed in a Petri dish lined with filter paper that is sprayed with the test compound at field dose to deliver the contact exposure. In this case bumble bees can be exposed via oral and indirect contact independently or in combination. The nest boxes are kept in the laboratory but connected outside with a tube in order to allow natural foraging.

The methods described by Whitehorn et al. (2012) and Gill et al. (2012) are both suitable to study the effects of pesticide on bumble bee colony (see original articles for the detailed protocols). The exposure should be determined according to the chapter 7 and associated flow charts. The major endpoints assessed in this study are: colony development (number of workers and weight gain of the colony), colony mortality, queen production.

Protection goal: The effects should not be more than 7% on total reproductive output, queen versus male production and queen survival and capacity to nest

### FIELD TESTS

Several approaches have been used to assess the effects of applications of pesticides on bumble bee colonies in the field (see EFSA Panel on Plant Protection Products and their Residues (PPR) 2012a for full list of references) but all require significant further work to be applied as regulatory study, including the minimum field size, the number of colonies per treatment, the methodology for dead bee assessments and foraging assessments and agreement of appropriate approaches for determining colony development. As long as this new method is not available and validated the combined field to laboratory studies should be used.

Protection goal: The effects should not be more than 7% on total reproductive output, queen versus male production and queen survival and capacity to nest.

## Appendix Q. TEST PROTOCOLS SOLITARY BEES (*OSMIA CORNUTA* AND *OSMIA BICORNIS* = *O. RUFa*)

### *Osmia cornuta* and *Osmia bicornis* (= *O. rufa*) as key species in the risk assessment for solitary bees

Two mason bees of the genus *Osmia* (*O. cornuta* and *O. bicornis*) are proposed as test species in the risk assessment scheme for solitary bees. *Osmia cornuta* and *O. bicornis* are very closely related species from the Palearctic region, and share many life history and behavioural traits. *O. cornuta* is distributed in central and southern Europe, Turkey and parts of North Africa and the Middle East (Peters, 1977). *O. bicornis* can be found also in northern Europe. These two species are considered as suitable test species because:

1. Species of the genus *Osmia* are already used in ecotoxicological studies and some protocols are available in literature (see EFSA Panel on Plant Protection Products and their Residues (PPR) 2012a for the full list of references).
2. These species are quite easy to rear and it is possible to obtain large populations (Kronic and Stanisavljevic L.Z., 2006); (Bosch, 2008).
3. compared with other species of solitary bees, the biology of these species is well known (Bosch et al., 2008).
4. They are economically important species and management methods have been developed to use various *Osmia* species as commercial pollinators used in crop pollination in Asia, North America and Europe (Bosch and Kemp, 2002).
5. The genus *Osmia* comprises more than 400 species in the world and they show several behaviour and life cycle traits representative of many species of solitary bees nesting above the ground.

They show also some limitations:

1. The soil exposure contamination could be underestimated in *Osmia* compared with the ground-nesting bees. In fact, *Osmia* spp. nest in pre-established cavities in which females build series of cells separated by mud partition; however, compared with the ground-nesting species, members the genus *Osmia* are less exposed to pesticide applied into the soil.
2. *Osmia cornuta* and *O. bicornis* populations fly early in the year for about two to three months and are univoltine. This means the tests on adults should be carried out during the spring; however, it is possible to manipulate emergence periods, rearing bees under artificial temperature regimes during wintering. Compared with the natural emergence period, wintering periods can be prolonged or shortened by a month without serious consequences for bee survival and post-emergence vigour. This allow the nesting period to be brought forward or delayed (for one to two months) so that the emergence period of the bee population coincides with the flowering period of the test crop (Bosch et al., 2008).

Two other species have been used in toxicological studies (*Nomia melanderi* and *Megachile rotundata*) in the USA as they are widely used as alfalfa crop pollinators in North America but not in Europe.

At the moment, official test protocols are not available for solitary bees. In this section the methods from literature to test compounds on *Osmia* spp. are proposed (see EFSA Panel on Plant Protection Products and their Residues (PPR) 2012a for the full list of references) but they have to be ring-tested

and validated. In order to obtain standardised results, it is recommended that *Osmia* populations used in the tests are reared under optimal temperature conditions according to their geographical origin (Bosch et al., 2008); (Sgolastra et al., 2012a).

## LABORATORY TESTS

### Acute oral toxicity test (adults)

The acute oral toxicity test is designed to establish the oral LD<sub>50</sub> (median lethal dose) value, i.e. the dose, expressed in µg of active substance per bee, inducing 50% mortality following oral exposure of measured amounts of active ingredients or commercial pesticide formulations.

In the oral toxicity test for *Apis mellifera* (EPPO 170 and OECD 213) a common feeder is provided to a group of workers assuming that, through trophallaxis, all individuals will receive similar doses of test solution. However, the current oral toxicity tests cannot be applicable to non-*Apis* bees because most other bee species do not show trophallaxis behaviour and thus an individual feeding is required.

*Test procedure:* During spring, *Osmia cornuta* (or *Osmia bicornis*) females should be used to run the test approximately 24 hours after emergence from their cocoons. Females should be starved overnight and then exposed to a compound the next morning.

For each test product, five concentrations are selected so as to range from 10 to greater than 100 % mortality with no more than twofold dilutions between doses. A control with bees fed only sugar solution is included in each test. A reference compound, e.g. dimethoate, should be used as toxic standard. After single exposure to test solution (see mode of treatment), three set of 10 bees per dose are transferred to a holding cage, provided with an artificial feeder. The artificial feeder can consist of a 5-mL LDPE sample vial, containing a sucrose solution, with a soaked cigarette filter inserted through the lid of the vial.

During the test bees are kept in an incubator at:  $t = 22^{\circ}\text{C}$ , relative humidity = 60–80%, light–dark = 12:12 hours.

*Mode of treatment:* *Osmia* females should individually fed 10 µL of test solution using an individual feeder with the “flower method” proposed by Ladurner et al. (2003). In the “flower method” the test solution is pipetted into a plastic ampoule, inserted into the calyx of a flower (i.e. cherry, *Prunus avium* L.). Flowers and bees are individually housed in holding cages and kept in an incubator at 22 °C under artificial light for one hour.

*Data assessment and reporting:* the LD<sub>50</sub> values (expressed in µg/bee) at 48 hours (providing that the study has not been extended because the mortality continues to rise) from exposure with 95% confidence limits have to be determined using probit analysis. Mortality data are corrected for control mortality using Abbott’s formula. As for the honey bees, any symptoms of intoxication observed in bees during laboratory toxicological tests should be recorded together with their duration, time of onset, severity and number of affected bees at each dosage level.

### Acute contact toxicity test (adults)

Methods used to study contact toxicity in *A. mellifera* can be easily applied to other species of solitary bees including *Osmia cornuta* and *O. bicornis*. The endpoint of this test is the contact LD<sub>50</sub> (µg/bees) following topical exposure.

*Test procedure:* As outlined above for the acute oral toxicity test.

*Mode of treatment:* *Osmia* females are cooled at 4 °C (for a maximum of 30 minutes) until they stopped moving. One microlitre of test solution is then applied to the dorsal surface of the thorax. The

test solution is prepared by dissolving each compound in acetone and purified distilled water (50% v/v) to obtain desired concentrations.

*Data assessment and reporting:* As outlined above for the acute oral toxicity test.

### **Chronic oral toxicity test, accumulative study and larval toxicity studies**

For the chronic and the larvae toxicity tests and for the assessment of the accumulative effect, it is proposed that the endpoints obtained in the tests carried out with honey bees should be used until an internationally agreed and adopted guideline is available for these tests.

#### **Oral toxicity test (larvae)**

The oral toxicity test on larvae of solitary bees is designed to study the effects of pesticide to solitary bee larvae at environmentally relevant concentration in laboratory conditions. This test is recommended when concerns on brood are highlighted at lower tiers using honey bees as surrogate (i.e. the ETRlarvae trigger is breached). In fact, unlike honey bee larvae, which feed primarily on secretions (brood food or royal jelly) from nurse bees, the eggs of most non-*Apis* species are laid directly on a loaf of pollen mixed with nectar, on which the larvae feed. That provision may contain much higher levels of pesticide contamination than the glandular secretions of nurse bees on which honey bee larvae feed. In the literature, some tests are available for *Megachile rotundata* and *Osmia* spp. in laboratory conditions (see EFSA Panel on Plant Protection Products and their Residues (PPR) 2012a for full list of references); however, they need to further improvements. A critical point is to obtain a homogeneous distribution of the test product in the mass provisions.

*Test procedure:* Provision masses with eggs are obtained from nests of *Osmia cornuta* or *Osmia bicornis* released in glasshouse or in an organic field with flowering oilseed rapes or other attractive crops for *Osmia* spp. (i.e. *Phacelia*). Artificial nests can consist of wood blocks with drilled holes filled with paper straws. During nesting period, nests should be checked daily and newly plugged paper straws (completed nests) are pulled out of the wood block and taken to the laboratory. Nests are then dissected and provisions with eggs are weighed and individually placed in clay wells or in 48-well culture plates. Eggs are sexed based on provision size and cell position within the nest (females are produced deeper in the nest and are assigned larger provisions). After the pesticide application (see mode of treatment), the clay wells or the culture plates with provisions and eggs are transferred in an incubator at constant temperature condition until adulthood (late summer). The optimal temperature condition during development and the period of adult emergence depends on the species and the origin of the population used in the test (Bosch et al., 2008; Sgolastra et al., 2012; Figure Q1). In the autumn, after ~ 30 days from adult eclosion, the bees are cooled for wintering (15 days at 14 °C + 150 days at 3–4 °C). After wintering, bees inside the cocoons are removed from the wells and individually caged with water availability but no food. Cocoons are checked daily for emergence of adult bees and their survival will be recorded.

*Mode of treatment and exposure:* Test product should be distributed within the mass provision as evenly as possible without removing the attached egg. The test product can be dissolved in water reaching the desired concentration and 50 µL of this solution per gram of provision is delivered into a longitudinal fissure or in a hole previously formed in the provision mass. The concentration of pesticide used in this study should be determined according to chapter 7).

*Data assessment and reporting:* The fresh pollen provisions with the attached eggs are weighed before treatment. Larval development and mortality are observed daily until cocoon spinning. Bee mortality is observed and recorded also after emergence. The percentage of bee mortalities (total number of bees dead during the development and not emerged from the cocoon after incubation) and other endpoints (the longevity, the larval development duration (from egg to the completion of cocoon spinning) can be used to calculate the NOEC.



**Figure Q1:** Life cycle and phenology of a univoltine *Osmia* species. The phenological variability in *Osmia* populations from different geographic area is indicated by dashed lines

### SEMI-FIELD TESTS

Semi-field tests are higher tier studies and they may be triggered as a result of possible concerns during the risk assessment. Moreover, semi-field and field tests are more appropriate to test sublethal effects (nesting behaviour) of pesticide to solitary bees.

There are no standardised guidelines but a number of methods have been published to test pesticides on solitary bees in cage, tunnel or glasshouse conditions (e.g. Ladurner et al. (2008), but see EFSA Panel on Plant Protection Products and their Residues (PPR) 2012a for the full list of references). Outlined below is a protocol for testing under semi-field conditions.

*Test procedure:* Nesting females of *Osmia cornuta* or *O. bicornis* are forced to forage on a attractive flowering crop in field cages. A common pollen–nectar source for *O. cornuta* and *O. bicornis* are *Phacelia tanacetifolia* Benth. With the onset of bloom, cages of ~40 m<sup>2</sup> each are confined within the field with anti-aphid screen cages (mesh size ≤ 3 mm) and a nesting shelter should be placed in the centre of each cage. Nesting shelters can consist of several wood blocks with drilled holes filled with paper straws. To facilitate observations, nesting cavities can numbered with white grease pencils.

During full bloom, 10–15 new emerged females of *O. cornuta* or *O. bicornis* are released together with 10–15 males in the cages. After starting of nesting activities (once at least five females per cage has established) the active ingredient is applied in the crop.

*Mode of treatment:* Test product should be applied in separate cages at the appropriate rate to ensure that exposure via pollen and nectar is in line with the exposure estimates (see chapter 7). One cage should be treated only with water (control) while an other one should be treated with a toxic standard. Each cage should be randomly assigned to a treatment. More cages per treatment can be used as replicates. The number of replicates must be high enough to account for the inter-cage variability and allow statistical analyses with adequate power of the test.

*Data assessment and reporting:* Observations on nesting activity should be performed before and after treatment in each cage. The number of nesting females and other parameters should be recorded on day 0 (day of treatment for evening applications; day before treatment for morning application), and on days 1, 2 and 4. For each nesting female, the following parameters are recorded on each of assessment days:

- In-nest time: the time spent inside the nest depositing pollen and nectar load in the morning during one hour of observation.
- Foraging time: the time spent outside the nest foraging for pollen and nectar in the morning during one hour of observation.

- Bee mortality: nesting cavities are inspected with a flashlight every night and the number of females inside is counted (night counts); in fact *Osmia* spp. females spend the night in their nesting cavity.
- Cell production rate: during the night counts, paper straws containing females are removed with forceps and nest progression is marked and dated on each straw.

At the end of the nesting activity, the marked nests are brought to the laboratory and dissected to record larval mortality. Temperature and relative humidity inside the cages should be recorded throughout the study.

The endpoints (bee mortality rate, cell production rate, foraging and in-nest times, progeny survival, off-spring production and sex ratios and body weights) are compared between treatments with appropriate statistical analysis.

Protection goal: not more than 7% difference compared to controls in cell production rate, off-spring production and sex ratio, progeny survival and vigour (the vigour can be assessed measuring the adult longevity after emergence) until next spring.

#### FIELD TESTS

Field studies are required when concern has not been adequately addressed at lower tiers and they are recommended in particular when the assessment for chronic or accumulative risks raise a concern. They can also be suitable to study the sublethal effects (e.g. orientations) in solitary bees under natural conditions. At present, field studies are not available in literature for *Osmia* spp. (see EFSA Panel on Plant Protection Products and their Residues (PPR) 2012a) for reference). In this section a protocol adapted from a study on *Megachile rotundata* (Torchio, 1983) is proposed.

*Test procedure:* Nesting females of *Osmia cornuta* or *O. bicornis* are released in nesting shelters placed in the centre of test fields of flowering crops. Nesting shelters can consist of several wood blocks with drilled holes filled with paper straws. To facilitate observations, nesting cavities can be numbered with white grease pencils. Test should be performed in spring during the natural period of *Osmia* nesting activity in accordance with the local climatic conditions. During blooming (with ~15% of open flowers), at least 400 females with a relative number of males (ratio 1♀:2♂) should be released per hectare of field. Each female should be individually marked in order to consider the potential dispersion of females from one site to another. Compared with honey bees, solitary bees show much smaller foraging area (range 200–400 metres); thus, a smaller size of field is necessary and the distance of one kilometre between nesting shelters should be sufficient for preventing cross-foraging between test and control fields. Alternatively, a large field divided into two nearly equal parts can be used. Each of these “half-fields” (plots) is subsequently used as treatment or control field. In any case, at the end of the nesting period, accidental cross-foraging can be verified by residue analysis of the mass provisions. After starting of nesting activities and in coincidence with the full blooming, the active ingredient is applied in the crop.

*Mode of treatment and exposure:* Control field/plot should be treated only with water and more fields/plots per treatment can be used as replicates. The number of replicates must be high enough to account for the inter-cage variability and allow statistical analyses with adequate power of the test. During spray applications, the nesting shelters should be protected from spray drift. The exposure should be in line with the exposure estimated (see chapter 7).

*Data assessment and reporting:* Observations on nesting activity should be performed before and after treatment in each field/plot. The number of nesting females and other parameters should be recorded on day -2, -1 and 0 (day of treatment for evening applications; day before treatment for morning application), and on days 1, 2, 3, 4 and 7. In case of pesticides that are applied as a solid, the

assessment period can be extended till the end of the blooming period. On each of the assessment days, the following parameters are recorded:

- Active nests: nesting cavities are inspected with a flashlight every night and the number of females inside is counted (night counts); in fact, *Osmia* spp. females spend the night in their nesting cavity.
- Cell production rate: during the night counts, paper straws containing females are removed with forceps and nest progression is marked and dated on each straw.

For substances for which effects on growth or development cannot be excluded (when concern has not been adequately addressed at lower tiers), it is possible to survey the progeny development and survival transferring the nests in laboratory. Progeny should be reared under standardised temperature conditions till next spring and the percentage of bee survival recorded (see laboratory test for larvae). The endpoints (number of active bees, cell production rate, progeny survival, off-spring production and sex ratios and body weights) are compared between treatments with appropriate statistical analysis.

Protection goal: not more than 7% difference compared to controls in cell production rate, off-spring production and sex ratio, progeny survival and vigour (the vigour can be assessed measuring the adult longevity after emergence) until next spring.

## Appendix R. TEST CROPS TO BE USED

### Spray applications

According to EPPO 170 (4), for testing of effects on honey bees following spray applications, in the first instance, rape, mustard, *Phacelia* or another crop highly attractive to bees should be used as test plants, e.g. in the case of a standard semi-field or field trial based on acute toxicity.

The EFSA Working Group recommends that *Phacelia* be used in semi-field and field tests for the following reasons:

1. It is a worst-case crop for spray applications as the highest exposure can be achieved due to:
  - maximum contamination of nectar and pollen in flowers is expected, as nectaries and anthers are directly exposed to the spray;
  - very high attractivity for bees;
  - very high density of foragers in semi-field and field trials per m<sup>2</sup>.
2. It is a crop which has features making it particularly suitable for semi-field and field tests because:
  - pollen is visually easy to distinguish from all other pollen sources (by its purplish colour);
  - flowering period can be adapted to time with low alternative forage in the surrounding to maximise exposure;
  - several plantings in season possible resulting in flowering at different times allows testing, e.g. at different times of year according to GAP or assessment of repeated applications;
  - ability to extrapolate the risk assessment carried out on *Phacelia* to a range of other crops.

In the EPPO 170 (4) guideline it is stated that, in other cases, identification of a surrogate (worst-case) test crop may be more difficult, e.g. for systemic compounds, where the test crop should be one for intended use.

This would also be recommended by the Working Group; for seed treatments the target crop, e.g. winter oilseed rape should be used. If the test is conducted with a crop which is not the target crop, residue analysis of nectar and pollen are required to determine the level of exposure to residues in these matrices.

## Appendix S. REFINEMENT OPTION FOR CROP SPECIFIC NECTAR AND POLLEN CONSUMPTION

### 1. Refinement option for crop specific nectar consumption

The nectar consumption of bees is dependent on the sugar content of the nectar. Therefore, it is necessary to consider the sugar content of nectar when determining the oral route of exposure of bees for the risk assessments. In the screening step and at the first tier of the risk assessment, default values of 10%, 15% or 30% are used (for details see Appendix J. for SVs). The value of 30% (average of 28 genera) should be used when the plants in the field margin or weeds in the treated field are considered. Refinement of this value is not recommended as the composition of these plants will vary in space and time (e.g. between fields or field margins, within a MS, between MSs, within a zone and between zones, from year to year or from season to season), and as a result it will be extremely difficult to establish a suitable generic value.

However, for crop plants (treated crop, adjacent crop and succeeding crop) it is recommended that the crop-specific sugar content of their nectar is determined. The measured crop-specific sugar content than can be used at the second tier of the risk assessment as an option for refinement (i.e. the default values of 15% for honey bees and bumble bees and 10% for solitary bees may be changed). If refined values are used for succeeding crop or adjacent crop, a reasoned case arguing what kind of crops are likely to be grown after the treated crop or likely to be as adjacent crops at the area of use (specifically to those that may attract pollinators at around the time of application) must be made.

The sugar content of the nectar is species dependent (Butler, 1944); (Wykes, 1953) and it may also vary between varieties of the crop. For example, the sugar content of 13 sunflower hybrids was studied in micro-parcels in Hungary in 2002. The average sugar content of the nectar of these varieties varied from 44.8 to 59.1% with an average of  $50.5 \pm 4.3\%$  (Szentcs, 2003). Similar results were concluded by Zajác from 2002 to 2003 (Zajác, 2011). In addition, the sugar content of the nectar depends on non-biological factors such as soil properties or weather conditions, especially air humidity (Butler, 1944).

Therefore, when determination of crop specific sugar content of the nectar is undertaken it is necessary to make measurements on different varieties and different field conditions. It should be noted that the sugar content of nectar is a generic issue and hence information obtained might be used for other risk assessments for the same crop. If the sugar content is to be refined, it is recommended to follow the procedure described below.

First, relevant information on the varieties of the crop grown in the area of intended use has to be gathered (preferable from the last two to three years). Using this information the varieties should be ranked and the major varieties should be identified. Major varieties are the ones that are grown over the largest surface of the area of intended use. It is acknowledged that the composition of the varieties grown changes from year to year and new varieties continuously appear on the market. Therefore, it is recommended to periodically reconsider the risk assessments that used refined sugar content.

It is recommended to use at least five of the most important (major) varieties to determine the sugar content of nectar. Lower number of varieties might be accepted; however, this needs to be justified. For example, if the number of varieties that are on the market of the area of intended use is less, then five or a fewer justifiably covers a significant (e.g. > 90<sup>th</sup>%) area from the area of intended use. A lower number of varieties may be accepted if preliminary data clearly showed that a worst case variety or varieties could be identified.

Nectar samples of each major variety have to be taken from at least five different fields in order to represent a range of different pedo-climatic conditions. A smaller number of situations (pedo-climatic conditions) might be accepted if justified (e.g. preliminary data allowed identification of the worst-case conditions for sugar production of the plants). Either artificial sampling (e.g. using micropipette

or other tools/methodology; see, for example, Corbet, 2003) or bees can be used for the nectar collections; however, it is recommended that a defined sampling methodology be used for one dataset. The sample size should not be fewer than 20 individual plants or bees at each sampling time and location. Within the fields, a random sampling should be performed including samples from the edge and from the middle of the fields at least two times a day. One sampling should be performed in the morning (e.g. 9–10 a.m.) and another in the afternoon (e.g. 1–3 p.m.). Each field should be sampled at least on two different days during the flowering period, preferably one in the first part of the flowering period and another close to the end of the flowering period. Ideally, the time of sampling should be fitted to the intensive foraging period of the bees (i.e. ideal meteorological conditions, considerable foraging activity observed). The sugar content (% w/w) of each sample has to be determined (e.g. refractometry, chemical analysis). Results of subsamples from the same day and same field can be averaged, although if significant differences between sets of subsamples (e.g. morning vs. afternoon samples or field edge vs. field centre samples) are observed, this must be reported. Also, the results from the same field, but from the different days during the flowering period (at least 2 sampling days are recommended) can be averaged. However, if significant differences between the sugar content measured on those days are observed, this must be reported.

This sampling regime will result in at least 25 average data if five varieties were studied on five fields of each. Within this dataset, the number of data originating from a field/sampling day combination should be balanced (i.e. the case that considerably more data originate from best-case situations than from worst-case combinations of field and sampling day should be avoided). As described above, this dataset can be used as a refinement of the exposure estimation at the second tier of the risk assessment schemes (see further guidance in Appendix N.). If residue analysis of nectar is undertaken (see Appendix F. ), it is recommended that the sugar content of the nectar samples is also determined. If these data are available, the sample number taken specifically for the sugar content determination might be lowered.

## 2. Refinement option for crop specific pollen consumption

It is necessary to consider the pollen consumption when determining the oral route of exposure of bees for the risk assessments. In the screening step and at the first tier of the risk assessment for the crop plants (treated crop, adjacent crop and succeeding crop), the highest (worst case) consumption values were considered as default. This is because data from the literature (Somerville and Nicol, 2006); (Tasei and Aupinel, 2008); (Nicolson and Human, 2012) indicated that the consumption of pollen by bees is crop dependent. These data also indicated that pollen with different quality (e.g. composition of nutrients) is produced by different plants. It is suggested that the main factor, which determines the consumption rate of bees is the protein content (the lower protein content of the pollen the higher the consumption). However, a clear relationship between protein content (and possible other nutrients) and the pollen consumption could not be established due to the few data that were available. Therefore, the crop-specific protein content of the pollen to be used to estimate the crop-specific pollen consumption is currently considered as only a potential option for higher tier refinements, but no detailed guidance for the methodology of this potential refinement (e.g. for second tier of the risk assessment as described in [Appendix N](#)) could be provided. If refined values are to be used, the relationship between the quality of the pollen and the pollen consumption needs to be proven. Feeding studies might be used to support the established relationship (however again guidance for the methodology cannot be provided).

As a general guidance (see also chapter 1 for crop-specific nectar consumption), if refined values are used for succeeding crop or adjacent crop, a reasoned case arguing what kind of crops are likely to be grown after the treated crop or likely to be as adjacent crops at the area of use (specifically to those that may attract pollinators at around the time of application) must be made. Refinement of crop specific pollen consumption for the scenarios for weeds in the treated field and plants at the field margin is not recommended (unless a large number of data for several genera relevant for the area of intended use are available).

## Appendix T. BACKGROUND TO THE EXPOSURE ESTIMATES AND TRIGGER VALUES USED IN THE RISK ASSESSMENT FOR GUTTATION

For seed treatments the estimation of the time-weighted average concentrations expressed as a percentage of water solubility is based on available measurements as model simulations are not yet available. EFSA Panel on Plant Protection Products and their Residues (PPR) (2012a) provided an overview of available measurements in guttation water of plants grown from treated seeds and this will be used in the following estimation.

The vast majority of the measurements were carried out with maize seeds treated with imidacloprid, clothianidin and thiamethoxam at rates ranging from 0.5 to 1.25 mg per seed. The few measurements of concentrations in guttation water available for other crops (winter oilseed rape, winter barley, sugar beet and wheat; see Figure H7 of the opinion of the EFSA Panel on Plant Protection Products and their Residues (PPR) (2012a), and (Reetz et al., 2011)) show concentrations that are considerably lower than those found for maize. The estimated values have been based on the results for maize as this is expected to result in conservative estimates for all crops.

Most of the measurements for imidacloprid, clothianidin and thiamethoxam in maize guttation water consider the course of time of the concentration after emergence. These measurements usually show a sharp exponential decline in the concentration water in the first few weeks after emergence of the guttation fluid. The highest value found for imidacloprid in field studies was about 250 mg/L (Figure H5 of the opinion of the EFSA Panel on Plant Protection Products and their Residues (PPR) (2012a)). The highest value found for clothianidin in field studies reported by the opinion of the EFSA Panel on Plant Protection Products and their Residues (PPR) (2012a) was about 100 mg/L (Figure H7 of the opinion of the EFSA Panel on Plant Protection Products and their Residues (PPR) (2012a)). However, a field study from Austria with clothianidin (Lückmann et al., 2010, dossier submitted by applicants) showed a peak value of about 700 mg/L; this was the highest value of six measurements at a certain point in time, three being close to 100 mg/L, one of about 20 mg/L and one of about 5 mg/L. So the average concentration at this time was about 170 mg/L. The highest value found for thiamethoxam in field studies was 172 mg/L (Table H1 of the opinion of the EFSA Panel on Plant Protection Products and their Residues (PPR) (2012a)). However, in a greenhouse study under extremely dry conditions a maximum thiamethoxam concentration as high as 1154 mg/L was found (Tapparo et al., 2011). The water solubility of imidacloprid is 610 mg/L, that of clothianidin is 340 mg/L and that of thiamethoxam is 4100 mg/L (FOOTPRINT database<sup>44</sup>). Based on this limited information we propose to assume as a default estimated peak concentration 100% of the water solubility.

Figure H7 of the opinion of the EFSA Panel on Plant Protection Products and their Residues (PPR) (2012a) also contains concentrations in maize guttation fluid of methiocarb showing a maximum of about 5 mg/L. The water solubility of methiocarb is 27 mg/L (FOOTPRINT database) which would give a default of about 11 mg/L so indeed above the measured maximum of 5 mg/L. Table H1 of the EFSA opinion on bees gives fipronil concentrations of 46 and 77 mg/L in maize guttation fluid from a laboratory study. However, the water solubility of fipronil is about 4 mg/L (FOOTPRINT database) so these measurements are unlikely to be reliable. Therefore, on the basis of these data, it is considered that the above proposal to use 100% of the water solubility is sufficiently precautionary.

The available measurements of the course of time of the concentration usually show an exponential decline (Figures H2 to H5 of the EFSA opinion on bees). As the underlying data were not available, declines were fitted visually by drawing a straight line and the following were obtained:

- half-lives of 3.3, 3.6 and 4.6 days for clothianidin from Figures H2 and H4,

<sup>44</sup> <http://sitem.herts.ac.uk/aeru/footprint/it/index.htm>

- a half-life of 2.3 days for imidacloprid from Figure H5, and
- a half-life of 3.0 days for thiamethoxam from Figure H2.

Figure H7 showed first an increase of the concentration of clotianidin up to the maximum of about 100mg/L followed by a sharp decrease. This decrease could be described with a half-life of 1.1 days. Based on this information it is proposed to use a half-life of five days to calculate the estimated twa concentrations in guttation fluid. This is considered to be conservative. In case semi-field studies are available (box 7 of the flow chart in Figure 1), it is preferable to derive the twa from the measured decline in these studies.

Thompson (2010) showed data from a Swiss field study on decline of clothianidin concentrations in guttation water of maize seedlings: the concentration was initially about 30 mg/L and it declined below 15 mg/L within five days. Reetz et al. (2011) found initial concentrations of clothianidin of about 8 mg/L in a German field study and this concentration decreased to below 1 mg/L within a week. Therefore, on the basis of the above, the proposed time course of the concentration in the guttation fluid is considerably more conservative than these findings.

In case of exponential decline, the twa concentration can be calculated with:

$$C/C_0 = (1 - e^{-kt}) / kt \quad (T1)$$

where  $C$  is the concentration as a function of time,  $C_0$  is the concentration at the start,  $k$  is the rate coefficient of the decline (equal to  $\ln 2$  divided by half-life) and  $t$  is the time period for averaging. Using a half-life of five days for  $t = 10$  days, gives  $C/C_0 = 0.54$ , so the 10-day twa concentration can be obtained by multiplying the peak concentration with 0.54. So this becomes  $0.54 \times 100\% = 54\%$  of the water solubility. Similarly, the five-day twa concentration gives  $C/C_0 = 0.72$  so this becomes 72% of the water solubility.

**Worker bee water consumption**—the assessment of adult worker bee exposure is based on a water consumption of 11.4  $\mu\text{L}/\text{bee}$ . This water consumption is based on Free and Spencer-Booth (1958), who measured water consumptions ranging from 5.8 to 11.4  $\mu\text{L}/\text{day}$  at 35°C. At 30 °C they found much lower water consumption than at 35°C (at most 0.8  $\mu\text{L}/\text{d}$ ). In the hive, adult workers keep the brood temperature between 32°C and 36°C with a mean of 34.5°C (Himmer, 1927);(Seeley and Heinrich, 1981);(Kronenberg and Heller, 1982). However, Becher et al. (2010) showed that the in-hive temperature linearly decreased from the core of the brood nest to the periphery with a slope of 0.45 °C/cm. Thus, 11.4  $\mu\text{L}/\text{bee}$  is considered to be a conservative value.

**Larval water consumption**—the assessment of larvae exposure is based on the conservative assumption that all the larvae food is diluted with contaminated water.

It is assumed that a honey bee worker larva needs 59.4 mg sugar and 1.5–2 mg pollen for five days (EFSA Panel on Plant Protection Products and their Residues (PPR) (2012a), Appendix D). If the lowest pollen value is used, the food consumption is 60.9 mg dry material over five days (i.e. 59.4 mg + 1.5 mg = 60.9 mg dry material in their food).

The water content of larvae food is 73.51% for young larvae within the first two days and 64.9% for older larva from days 3 to 5 (Haydak, 1943). The corresponding dry matter percentages are 26.49% for young larvae and 35.1% for old larvae. The amount of water over five days is calculated as 169 mg (60.9 mg/26.49 \* 73.51) or 112.6 mg (60.9 mg/35.1 \* 64.9) for young and old larva, respectively. In this calculation, the honey is assumed to be uncontaminated and the water content of honey is assumed to be 18% (White, 1976). The consumption of contaminated water was therefore 138.6 mg and 92.3 mg. The average over five days from consumption of larvae food with 73.51% water (two days) and

larvae food with 64.9% water (three days) was 110.82 mg over five days. For the following calculations this has been rounded to 111 mg (assumed equal to 111  $\mu$ L) over five days.

The water consumption was also calculated with other methods resulting in slightly lower water consumption rates.

The use of a five-day time-weighted average PEC is proposed since the half-life for the decline in residues in guttation is assumed to be very short (see above). It is acknowledged that the use of a two concentration may underestimate the exposure of the first larval stages which consume more water in relation to their body weight than the older larval stages. However, the loss of early larval stages from a peak exposure would not have such a high energetic cost for the colony than losing later larval stages. The exposure of later larval stages is covered by the time-weighted average approach and hence considered to be protective enough.

### **ETR trigger for drinking guttation water**

The same trigger value as for the oral exposure applies also for drinking water exposure.

## **Appendix U. TEST PROTOCOLS TO ASSESS THE EFFECTS OF PESTICIDES IN GUTTATION ON HONEY BEES**

The residues in guttation droplets represent a potential exposure route for bees. Specific test protocols in field conditions are required to assess the effects of guttation to honey bees if the risk is not acceptable in the first tier. In this section the recommendations on how to carry out these tests are provided.

### **FIELD TEST**

In general, the test should be designed as proposed in Appendix O. of the final Guidance Document but specific recommendations listed below have to be considered:

1. The test crop: the study should be carried out in the crop where the plant protection product will be registered. The study should be performed at the emergence of the crop or when the plants are in very young stages because in this moment the residues concentrations in guttation droplets are higher.
1. Location of the colonies in the field: colonies should be placed at the edge of the treated fields in order to maximise the exposure to guttation.
2. Duration of the study: from emergence of the crop up to 6 weeks after emergence. The colony survival after wintering should be recorded.
3. The test is considered valid if at least one guttation event occurs
4. Assessments: the occurrence of the guttation and the number of dead bees (in the dead bee traps and on linen sheets) should be recorded every day during the study period. The residue analyses must be performed on the guttation (at emergence and at several successive assessments during the study) and dead bees (only in case of abnormal mortalities). Colony development should be assessed as proposed in Appendix O.
5. Feeding: food should be provided via additional honey combs in the hives or sugar paste in case no forage is available during the test (e.g. in autumn).

Permanent water sources should be located as far away as possible from the hives and test fields (the minimum distance should be longer than the 90<sup>th</sup> percentile distance).

## Appendix V. ASSESSMENT OF UNCERTAINTY

As outlined in the chapter on uncertainty every refined assessment should contain at least a qualitative evaluation of uncertainties. Outlined below is some guidance aimed at aiding the determination of uncertainty in higher tier studies. The guidance falls into two separate sections. The first is aimed at providing an indication of the type of questions or issues that should be considered by a risk assessor when they are assessing higher tier studies. It should be noted that this list is not exhaustive and will vary from study to study. The second section is a brief illustration of the assessment of uncertainty for two fictitious datasets. It should be noted that is only a brief example and is aimed at highlighting the way in which such an assessment could be presented.

### Uncertainty analysis for individual higher tier studies (residues studies and effects studies)

Outlined below is a proposal for a checklist to characterise the uncertainty in the higher tier studies. The points listed are not definitive or exhaustive and will change from study to study. The outcome of the analysis of this assessment can feed in the overall assessment of uncertainties (as in the tables below).

The example below is for an application via a spray and covers both the exposure and effects part. It is provided for illustrative purposes only. It is provided to highlight the types of questions that should be considered by the risk assessor when they are evaluating higher tier studies.

This type of assessment should be repeated for all exposure scenarios and accompanying assessments (e.g. adjacent crops or following crops).

### Exposure studies

**Table V1:** Uncertainty matrix for the exposure refinement with measurements of residues in fields (according to Appendix G. in the Guidance Document)

Source of uncertainty	Detailed description	Assessment of its level (low, medium, high)	Justification for the assessment
<b>Measurement in nectar, pollen and dust: sampling</b>			
Location of test sites (fields) and strategy for choosing them			
Measurement of the applied amount			
Sampling method (e.g. random, etc.)			
Residue analysis			
Number of samples			
Location of samples and strategy for choosing them			
Sampling timing (peak concentration covered?)			
<b>Measurement in nectar, pollen and dust: analytical method</b>			
Quantification and detection limits			
Analytical method used (and if other methods exist, with their comparative performance, handling of samples after collection in field)			
<b>Statistics</b>			
Preparations of raw data (e.g. pooling) before statistical analysis			
Statistical method used for identifying the average of one treated field (at the peak concentration) (this has to be repeated for the other fields)			

Source of uncertainty	Detailed description	Assessment of its level (low, medium, high)	Justification for the assessment
Confidence interval			
<b>Potential confounders</b>			
Influence of the temperature and weather conditions of the year (e.g. no extreme weather conditions, prolonged rain period, etc.)			

## Effects studies

**Table V2:** Uncertainty matrix for the effects in a field study (see Appendix O. on effects studies)

Source of uncertainty	Description	Assessment of its magnitude (low, medium, high)	Justification for the assessment
<b>Precision of the effects measurement</b>			
For the assessment of the colony strength were details provided on the methodologies used. For visual assessment: e.g. competence of the observer and provide pictures of the evaluation of the bee population)			
Measurement of mortality (techniques used)			
Measurement of foraging activity including behavioural effects (techniques used)			
<b>Correct experimental conditions and parameters</b>			
Location of test sites (fields) and strategy for choosing them			
Duration of observation during the flowering period			
Total duration of the flowering period (in days) versus duration during which the hives were exposed			
Quantitative level of the diseases mentioned in the guidance, at the beginning and in the end of the experimentation			
Choice of the crop used			
Extrapolation from one crop to another			
Population size (in number of bees) at the beginning and the end of the experiment			
Area of alternative foraging sources available			
Method for measuring the area of alternative foraging sources (e.g. questionnaires with farmers)			
Area of each study site			
Genetic origin of the colonies			
The queen—age and sisterhood with queens of other hives			
Origin of the colonies (where were they before the experiment)			

Distance between the control and test sites			
Frequency of hive observation			
Time for hive observation (how many minutes, at which time of the day, what happens if the weather does not allow observation)			
<b>Potential confounders</b>			
Area of attractive crops present in the stocking zone, after the exposure period			
Hives nourishment during the stocking period (quantity, frequency, content — e.g., sugar syrup),			
Estimated surface covered by other plants in an area of three kilometre (radius) around the hive and if these plants are attractive to bees, split in the following categories: – other crops,—weeds in the treated field – adjacent crops – plants on field margins			
Farmers' practices of application and dosing in the foraging area of the test and control colonies			
<b>Exposure assessment in the effects study</b>			
Maximum in time of concentration of residues in nectar and pollen entering the hive adequately assessed?			
<b>Statistics</b>			
Studies designed to detect required effect thresholds (no. of hives and study sites were sufficient)			
Statistical method used			
Confidence interval			
Statistical power			
Statistical unit used			
Further preparations of raw data (e.g., pooling) before statistical analysis			

### **Qualitative assessment of uncertainty**

Outlined below are two examples of an assessment of the uncertainty of a dataset and accompanying risk assessment. It should be noted that these are very brief; however, they aim to illustrate the manner in which the information could be presented.

#### **Example 1**

##### **Background**

The product is to be used on oilseed rape as a spray before and during flowering. The following assessment only covers the risk from the consumption of nectar and pollen from the treated crop. The assessment of uncertainty should be repeated for all other routes of exposure, for example adjacent crops, field margins, etc.

First tier: All HQ and ETR fail the relevant trigger values, however the compound doesn't pose a risk via accumulation. The use of risk mitigation measures have been considered, however they would remove the usefulness of the product and therefore higher tier data and associated assessment is required.

Higher tier study submitted:

Studies on the residues in pollen and nectar were conducted according to the Guidance Document, i.e. a range of sites representative of where the product will be grown within the zone (i.e. sites represent a range of soil and climate conditions). The number of sites selected is in line with the Guidance Document. Data have also been submitted to indicate the 'dilution factor', i.e. a factor that takes into account the difference between residues in pollen and nectar from the treated plants and those in the colony.

Field studies on oilseed rape —residues in all studies/hives have been determined to be at least equivalent to the 90th percentile exposure estimate. Sufficient studies submitted to detect required effect.

Effects on colony strength were < 7%; mortality < 1.5 times the control over three days.

**Table V3:** Worked example of a qualitative assessment of the uncertainty in a field study

Source of uncertainty	Potential to make true risk lower	Explanation	Potential to make true risk higher	Explanation
Exposure studies	+++	All studies conducted according to the Guidance Document, i.e. an appropriate range of soil/climate conditions. Studies submitted to determine dilution factor are acceptable.	-	True exposure is unlikely to be worst.
Exposure in field studies	+++	Exposure in field studies were in line with that determined to occur as a result of residue studies. In-field measurements of foraging and pollen identification indicate adequate exposure as well.		True risk is unlikely to be worst than this as in reality dilution due to adjacent crops and flowering weeds will occur.
Effects in field studies	+++	Demonstration that bees were exposed to at least a 90th percentile, colonies were healthy and monitored throughout.	-	Only potential issue is that different strains of bees may react differently from those selected.
Overall assessment	Underlying studies are in line with those recommended and as a result uncertainties minimal and would indicate that the true risk is lower than that assessed.			

## Example 2

Use on oilseed rape as a spray before and during flowering.

First tier: All HQ and ETR fail the relevant trigger values, however the compound doesn't pose a risk via accumulation. The use of risk mitigation measures have been considered, however they would remove the usefulness of the product and therefore higher tier data and associated assessment is required.

Higher tier study submitted:

Studies on the residues in pollen and nectar were conducted according to the Guidance Document, however only one study was carried out. No work has been carried out to determine potential dilution factor.

Field studies on oilseed rape—residues in pollen and nectar are in line with the above study. Monitoring of bee activity indicated that bees were foraging the crop in line with the control (i.e. both in terms of bees/m<sup>2</sup> and pollen analysis).

Effects on colony strength were < 7%; mortality < 1.5 times the control over three days.

**Table V4:** Worked example of a qualitative assessment of the uncertainty in a field study

Source of uncertainty	Potential to make true risk lower	Explanation	Potential to make true risk higher	Explanation
Exposure in field studies	+	Exposure in field study was potentially in line with that determined in one study. No other information available. The true residue could be much higher.	--	Uncertainty as to what the exposure has been in the field studies.
Effects in field studies	+	Lack of demonstration that bees were exposed to at least a 90th percentile in-hive, although evidence that the bees foraged the treated crop.	--	Exposure could be less than the 90th percentile, hence the effects could be greater.
Overall assessment	Much uncertainty regarding the exposure, therefore there is a lack of certainty whether the SPG will be met.			

## Appendix W. ILLUSTRATIVE SCHEME FOR ASSESSMENT OF SUBLETHAL EFFECTS

Sublethal doses can be defined as a fraction of the LD<sub>50</sub>. Sublethal doses are often an order of magnitude below lethal doses (below LD<sub>50</sub>/10). Such sublethal effects have been reported for a variety of endpoints including biochemical, physiological and behaviour endpoints (cholinesterase activity, survival, development, longevity, locomotion or mobility, navigation or orientation, feeding behaviour and learning performance). The integration of sublethal dose effects can provide a better understanding of short-term and long-term effects on honey bees, bumble bees and solitary bees.

A comprehensive review of the literature has been performed in the opinion of the EFSA Panel on Plant Protection Products and their Residues (PPR) (2012a). It is recommended in the opinion that sublethal effects should be taken into account and observed in laboratory studies. Potential laboratory methods to investigate sublethal effects would be testing of *Bombus* microcolonies to investigate effects on reproduction, proboscis extension reflex (PER) test for neurotoxic effects and homing behaviour for effects on foraging, including orientation. However, it is also acknowledged in the opinion that further research is needed in order to integrate the results of these studies in the risk assessment scheme.

The following issues were identified by the experts developing the Guidance Document which need to be solved before sublethal effects can be fully integrated in a risk assessment scheme:

1. protection goals and trigger values in first tier;
2. interpretation of sublethal effects in terms of effects on the colony;
3. exposure assessment goals for homing flight study;
4. interpretation of effects observed in the homing flight study.

### 1. Protection goals and trigger values in first tier

A link needs to be made between the magnitude of sublethal effects observed in the laboratory study and potential effects in the field in order to establish a trigger value for the first tier assessment.

The protection goal is based on effects on colony size. The link between colony size and forager mortality was the basis for establishing trigger values in the screening step and first tier risk assessment (see [Appendix M](#)). It is not possible with the information available to the working group to make a quantitative link between sublethal effects observed in first tier laboratory studies and potential effects on colonies. For example the proboscis extension reflex (PER) test can give an indication of general neurotoxicity affecting learning and behaviour of bees. However it is unclear to which extent an effect observed in the PER test will have adverse effects on the colony.

One option could be to treat effects observed in the PER test like mortality and apply the same protection goals as for forager mortality. However, such an approach may lead to a very conservative first tier risk assessment.

Without a quantitative link between sublethal effects and effects on colonies any suggested trigger value will be arbitrary and it is unclear whether the specific protection goal will be met or not.

### 2. Interpretation of sublethal effects in terms of effects on the colony

The interpretation of sublethal effects in terms of effects on the colony is not always straight forward. If for example a general increase in locomotor activity is observed in a laboratory study then it could be interpreted either as an adverse effect or as a positive effect (more active bees might collect more pollen and nectar). A decrease in locomotor activity could be interpreted as an adverse effect as it

would decrease the ability of bees to collect nectar and pollen. However, less active forager bees would bring back less contaminated pollen and nectar from the treated field to the colony and hence the exposure of the colony would be less.

Without further work, it is difficult to interpret the importance of sublethal effects that may occur in a laboratory study.

### 3. Exposure assessment goals for homing flight study

The current exposure assessment goal is based on the 90<sup>th</sup> percentile of colonies next to the treated field. The choice was made because a colony next to a treated field is a worst-case situation in terms of exposure of the colony. However, the worst-case situation for foragers whose orientation is affected is different. A field which is further away from the colony would cause a higher effect on foragers because the orientation is more challenging. However, in terms of exposure of the colony it would be less severe. This could only be solved with modelling including the behaviour of bees. Such an exposure modelling would need to be developed in future.

### 4. Interpretation of effects observed in the homing flight study

Effects observed in the homing flight study could be interpreted in a similar way as forager mortality (bees which do not find the way back could be considered as dead). In order to make the link to the protection goal of colony size it would need to be defined what percentage of foragers will fly to the treated field a certain distance away from the colony.

As an example on how effects could be interpreted:

As a basic assumption it is assumed in the risk assessment that 100 % of foragers will fly to a field which is, for example, one kilometre away.

In a homing study, 5% of foragers in the controls and 50% of foragers from the treatment group get lost on the way home from a release point one kilometre away. This result could then be interpreted as an increase of mortality by a factor of 10 for one day. This would clearly exceed the protection goal of increase of average forager mortality.

However, there are several issues related to this scenario which potentially overestimates the risk to bees.

1. The assumption that 100% of foragers will fly to a field which is, for example, one kilometre away from the hive may happen only in rare cases if, for example, the treated field is very attractive to bees and no alternative food sources are closer to the colony. In case of crops which are not highly attractive to bees the underlying assumption that all foragers will fly to the treated crop will lead to an overestimation of the overall impact on foragers of a colony.
2. Foragers which get lost on their way back to the colony will not be able to communicate the source of nectar and pollen. This has two consequences:
  - Fewer foragers will fly to the treated field and hence less foragers will be affected.
  - Fewer foragers will bring back residues from the treated field to the colony.

It would be possible to suggest a risk assessment integrating a homing flight study but it would be over precautionary if it is based on the assumptions as outlined above.

Overall, it is concluded that without solving the issues listed above it would not be possible to suggest a robust risk assessment scheme addressing sublethal effects. Therefore, only a first proposal for a future risk assessment scheme is included in this appendix.

The risk assessment which is presented is for illustrative purposes only and hence indicates how a future risk assessment scheme for sublethal effects could look like. It is the intention to highlight which issues need to be resolved (e.g. by further research) before such a scheme can be implemented in the regulatory practice.

The illustrative risk assessment scheme below should in principle cover all possible sublethal effects related to behaviour, orientation, learning, locomotion (all related to neurotoxic effects). It does not cover effects on reproduction or thermogenesis. Sublethal effects related to brood care are already covered by the standard risk assessment.

### Effect studies required:

- Observation of sublethal effects in standard acute contact test.
- Observation of sublethal effects in standard acute oral test.
- Observation of sublethal effects in LC<sub>50</sub> test
- PER test

The lowest NOEC from the acute oral test, LC<sub>50</sub> and PER test should be chosen for assessing the risk from oral exposure. The NOEC for contact exposure is used to assess the risk from contact exposure.

The endpoints are **NOEC sublethal contact** and **NOEC sublethal oral**

### 1. Screening:

Calculate ETR for sublethal effects:

#### Contact exposure:

$$HQ = AR/NOEC_{\text{sublethal contact}}$$

Where: AR = application rate in g a.s./ha  
 NOEC sublethal contact is expressed in µg a.s./bee

HQ trigger needs to be established.

If HQ sublethal contact < trigger then go to 4 (uncertainty analysis). If HQ sublethal contact > trigger then consider the need for risk mitigation measure or further effects data—see higher tier studies below under point 5.

#### Oral exposure:

$$ETR_{\text{sublethal effects}} = AR * SV/NOEC_{\text{sublethal}}$$

Where: AR = application rate in kg/ha

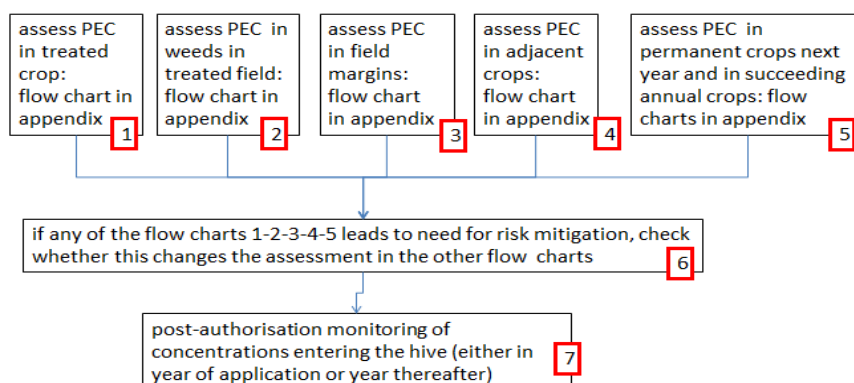
SV = shortcut value (see Table J3 of [Appendix J](#)).

ETR trigger = needs to be established

If the trigger is breached proceed with first tier risk assessment (point 2)

## 2. First tier assessment

When concern has been raised regarding the potential risk to honey bees from the consumption of pollen and nectar in the screening step it is proposed that the initial step of the refined risk assessment is to refine the exposure estimate used in the above calculation. In order to do this it is necessary to consider all the appropriate routes of exposure.



$$\text{ETR sublethal effects} = \text{AR} * \text{SV}/\text{NOECsublethal}$$

For shortcut values (SV) see table J4-J7 of Appendix J.

If concern is raised at the first tier (ETR is breached for one of the scenarios) then refinement is required. It may be possible to find a safe use by introducing risk mitigation measures or it may be appropriate to further refine the exposure estimate and use these data in a refined risk assessment, i.e. replace the default values with crop/compound specific values. It may, alternatively be appropriate to carry out a semi field or field effects study as outlined under point 3.

## 3. Higher tier effects studies:

1. **Standard semi-field and/or field tests** address all potential adverse effects on the colony (including foragers, in-hive bees and larvae) from sublethal effects observed in the standard acute oral test, LC<sub>50</sub> test and in the PER test. However, effects on orientation would not be sufficiently addressed. The colonies are close to the treated field in standard semi-field and field tests and the conditions are not challenging enough to detect effects on orientation of forager bees. Therefore additional studies are needed (see below).
2. **Labyrinth test.** This test could be done before a homing flight study is conducted. If no effects are observed in the labyrinth test then no further testing is needed. However, if there are effects at field relevant concentrations then a homing study is required.
3. **Homing study**

If no effects are observed in the higher tier studies then go to 4 (uncertainty analysis).

#### 4. Uncertainty analysis

Analyse uncertainties in the risk assessment as well as the underlying data to determine the uncertainty in the assessment and in particular whether the SPG will be met (see chapter 2). Summarise all data, associated risk quotients and uncertainties and conclude on the risk assessment.

## Appendix X. INVENTORY OF EXPOSURE FACTORS (Ef) TO BE USED IN THE RISK ASSESSMENT SCHEMES FOR THE ESTIMATION OF THE ORAL ROUTE EXPOSURE

This appendix collects and summarises all factors that are used for the exposure estimations for the different scenarios (e.g. spray drift factor for field margin scenario) for assessing the oral route of exposure. The aim of this appendix is to provide a brief overview of those factors and present them in a structured way to ease the use of them (Table X1). All data reported here originates from the exposure chapter (5), where the derivation of these factors with appropriate explanations and guidance for the use of them is available. As recommended by the exposure chapter, for the scenarios for weeds in the field, plants at the field margin and adjacent crop, the data from the following tables are used: (1) “Deposition factors for bird and mammal plant food items according to BBCH growth stages (derived from FOCUS, 2001)” (origin: Table 2 of Appendix E. of EFSA, 2009); (2) “Conservative default deposition percentages for spray drift and dust drift to be used for the different combinations of application technique and types of plants” (origin: Table H1 of Appendix H.). Copies of these tables are available in this Appendix as Table X2 and Table X3. Beside these tables, further data were taken from Appendix N (one of the Appendix of the exposure chapter). Table X1 contains the exposure factors (Ef) to be used for the different combinations of risk assessment schemes and scenarios as well as all other factors that were used for the derivation of these exposure factors (i.e. deposition factor, dust formation factor and safety factor). The exposure factor (Ef) is simply the multiplication of those factors, i.e.  $Ef = \text{Deposition factor } (f_{dep}) \times \text{Dust formation factor (worst case default dust formation from granules)} \times \text{Safety factor (extrapolation from spray drift to dust drift)}$ . Where it was necessary, the data (percentages in Table X3) were transformed to unit less values for Table X1 thus they can directly be used in the equations of the risk assessment schemes (the value for the relevant crop type needs to be used). The deposition factors ( $f_{dep}$ ) from Table X2 (scenario for weeds) are not included in Table X1, instead a reference to Table X2 are used. The relevant factor for the weed scenario needs to be chosen from Table X2 considering the crop type and growth stage of the treated crop at the time of the application.

Only those combinations are considered in Table X1, where the use of an exposure factor is necessary. For the scenarios where no exposure factor is indicated here, but the equation of the risk assessment contains this factor, a factor of 1 needs to be used (with the practical meaning that the exposure estimation by the other elements of the equation will not be modified; please note that this does not necessary mean that any Ef factor is applicable for those situations; the figure of 1 is just the mathematical solution for the equation). For example, no exposure factor should be used for the treated crop scenarios for spray applications (or Ef of 1 must be used).

**Table X1:** Exposure factors (Ef) to be used in the risk assessment schemes for different scenarios

Application technique (risk assessment scheme)	Scenario	Deposition factor ( $f_{dep}$ ) ( $f_{dep}$ are for the oral route of exposure)	Dust formation factor	Safety factor	Exposure factor (-)
Spray application	Weeds in the field <sup>(1)</sup>	Take $f_{dep}$ value from table X2	–	–	$f_{dep}$ (from table X2)
	Plants at the field margin	Field crops: 0.0092 Orchard-early: 0.097 Orchard-late: 0.052 Grapevine-early: 0.009 Grapevine-late: 0.027 Hops: 0.064	–	–	Field crops: 0.0092 Orchard-early: 0.097 Orchard-late: 0.052 Grapevine-early: 0.009 Grapevine-late: 0.027 Hops: 0.064
	Adjacent crop	Field crops: 0.0033 Orchard-early: 0.066 Orchard-late: 0.031 Grapevine-early: 0.0047	–	–	Field crops: 0.0033 Orchard-early: 0.066 Orchard-late: 0.031 Grapevine-early: 0.0047

		Grapevine-late: 0.0143 Hops: 0.041			Grapevine-late: 0.0143 Hops: 0.041
Seed treatment <sup>(2)</sup>	Plants at the field margin	Maize with deflector: 0.0056 Maize without deflector: 0.056 Oilseed rape with deflector: 0.0022 Oilseed rape without deflector: 0.022 Cereals with deflector: 0.0033 Cereals without deflector: 0.033 Sugar beets with deflector: 0.00001 Sugar beets without deflector: 0.0001	–	3	Maize with deflector: 0.0168 Maize without deflector: 0.168 Oilseed rape with deflector: 0.0066 Oilseed rape without deflector: 0.066 Cereals with deflector: 0.0099 Cereals without deflector: 0.099 Sugar beets with deflector: 0.00003 Sugar beets without deflector: 0.0003
	Adjacent Crop	Maize with deflector: 0.0027 Maize without deflector: 0.027 Oilseed rape with deflector: 0.0011 Oilseed rape without deflector: 0.011 Cereals with deflector: 0.0016 Cereals without deflector: 0.016 Sugar beets with deflector: 0.000005 Sugar beets without deflector: 0.00005	–	3	Maize with deflector: 0.0081 Maize without deflector: 0.081 Oilseed rape with deflector: 0.0033 Oilseed rape without deflector: 0.033 Cereals with deflector: 0.0048 Cereals without deflector: 0.048 Sugar beets with deflector: 0.000015 Sugar beets without deflector: 0.00015
Granular application	Treated crop <sup>(3)</sup>	–	0.1	3	0.3
	Weeds in the field <sup>(1)</sup>	Take $f_{dep}$ value from table X2	0.1	3	$0.3 \times f_{dep}$ (from table X2)
	Plants at the field margin	0.032	–	3	0.096
	Adjacent crop	0.015	–	3	0.045

Note: crop names appearing in the table are always referring to the crop of the treated crop scenario and not for the adjacent crop or for plants at the field margin scenarios

–: not relevant/not exist (for mathematical purposes it could be considered as 1).

<sup>(1)</sup>: By using an  $f_{dep}$  factor for the weed scenario, the crop interception is considered. However, in some circumstances, such as (but not restricted to) herbicidal applications in crops planted in wide rows (i.e. orchards, vines, strawberry, bush and cane crops), the pesticide application is not crop directed (e.g. spray application between the rows or under the trees). For those situations no interception factor should be considered and an  $f_{dep}$  of 1 should be used. For situations when no crop interception should be considered and the weeds are not emerged (BBCH of the weeds < 10) the Ef of 1 should be used (e.g. when the application is made for bare soil).

<sup>(2)</sup>: For risk assessments for those crops those are not listed here, the factors for maize should be used.

<sup>(3)</sup>: Relevant only for granules for broadcast application after emergence and not relevant for granules applied before emergence.

**Table X2:** Deposition factors to be used for the weeds in the treated field scenario (original title: Deposition factors for bird and mammal plant food items according to BBCH growth stages (derived from FOCUS, 2001))

Crop	Relevant principal BBCH growth stage	Interception according to FOCUS 2001	Deposition Factor
Bare soil	Not applicable	-	-
Bulb vegetables	≥ 4	0.4	0.6
Bush and cane fruit (not tabulated, surrogate value from vineyard)	≥ 1	0.4	0.6
	≥ 2	0.5	0.5
	≥ 4	0.7	0.3
Cereals	≥ 3	0.5	0.5
	≥ 4	0.7	0.3
Cotton	≥ 5	0.75	0.25
Fruiting vegetables	≥ 5	0.7	0.3
Grassland	Not applicable	-	-
Hop	≥ 1	0.2	Not applicable**
	≥ 2	0.5	0.5
	≥ 4	0.7	0.3
Leafy vegetables	≥ 5	0.7	0.3
Legume forage	≥ 5	0.7	0.3
Maize	≥ 3	0.5	0.5
	≥ 4	0.75	0.25
Oilseed rape	≥ 3	0.7	0.3
	≥ 4	0.75	0.25
Orchards	≥ 1	0.2	0.8
	≥ 2	0.4	0.6
	≥ 4	0.7	0.3
Ornamentals/nursery (not tabulated, surrogate value from leafy vegetables)	≥ 5	0.7	0.3
Potatoes	≥ 4	0.7	0.3
Pulses	≥ 5	0.7	0.3
Root and stem vegetables	≥ 4	0.7	0.3
Strawberries*	≥ 4	0.6 value from FOCUS 2000	0.4
Sugar beet	≥ 4	0.75	0.25
Sunflower	≥ 3	0.5	0.5
	≥ 4	0.75	0.25
Vineyard	≥ 1	0.4	0.6
	≥ 2	0.5	0.5
	≥ 4	0.7	0.3

\*The strawberry scenario is different from other arable fields, because the crop is typically grown in rows separated by broad bare soil strips, with either crop-directed treatments using three-nozzle fork sprayer (fungicides, insecticides) or between-row treatments (herbicides).

\*\*No consideration of interception for hops before side shoot formation, because it is cultivated like an arable crop at this early stage.

Notes:

- Deposition factor are indicated as  $f_{dep}$  in other parts of the appendix.
- For principal BBCH growth stage less than (<) the lowest value indicated in the table, an  $f_{dep}$  of 1 should be used (e.g. cereals BBCH < 3 will define an  $f_{dep}=1$ )
- For bare soil situations (i.e. pre-emergence applications) an  $f_{dep}$  of 1 should be used

- For further guidance on crop allocation into the crop categories used by this table see Table 5 of EFSA, 2009

- At the time of the finalisation of this guidance document, the crop interception values (hence the  $f_{dep}$  values) are under revision. The bases of the revision is the EFSA external scientific report by Olesen and Jensen (2013). Once the review of the crop interception values are finalised by EFSA and its report has been noted; this new data set might be used instead of the above table. New interception factors will become available in the near future in the EFSA guidance document: 'EFSA Guidance Document for evaluating laboratory and field dissipation studies to obtain DegT50 values of plant protection products in soil (In prep.).

**Table X3:** Deposition percentiles to be considered for the plants at the field margin and adjacent crop scenarios (original title: Conservative default deposition percentages for spray drift and dust drift to be used for the different combinations of application technique and types of plants.)

Application type	Crop	Default deposition (%) to be used for		
		Concentrations in nectar and pollen entering the hive		Contact exposure assessment
		Field margins	Adjacent crops	Field margins
Spray applications (spray drift)	Field crops	0.92	0.33	2.8
	Orchard – early stage	9.7	6.6	29.2
	Orchard – late stage	5.2	3.1	15.7
	Grapevine – early stage	0.90	0.47	2.7
	Grapevine – late stage	2.7	1.43	8.0
	Hops	6.4	4.1	19.3
Seed treatments (dust drift)	Maize with deflector	0.56	0.27	1.7
	Maize without deflector	5.6	2.7	17
	Oilseed rape with deflector	0.22	0.11	0.66
	Oilseed rape without deflector	2.2	1.1	6.6
	Cereals with deflector	0.33	0.16	0.99
	Cereals without deflector	3.3	1.6	9.9
	Sugar beets with deflector	0.001	0.0005	0.003
	Sugar beets without deflector	0.01	0.005	0.03
Granule applications (dust drift)	All crops	3.2	1.5	9.6

**Appendix Y. EFSA SCREENING STEP AND 1<sup>ST</sup> TIER CALCULATOR BEE RISK ASSESSMENT**

See attached Excel sheet ([Appendix Y EFSA Screening step and 1<sup>st</sup> tier calculator bee risk assessment, BeeTool v1](#)).

**Appendix Z. EFSA MONTE CARLO CALCULATOR TOOL FOR EXPOSURE REFINEMENT**

See report on [SHVAL tool](#)

## GLOSSARY AND ABBREVIATIONS

a.s.	active substance
BBCH	growth stage; uniform coding of phenologically similar growth stages of all mono- and dicotyledonous plant species
CA	concentration addition
DW	Downward spray, it includes all application methods where the spray is directed to the ground e.g. boom sprayer, localised applications with special equipment in rows)
EA	Exposure Assessment
EC <sub>50</sub>	Concentration required killing half the members of a tested population after a specified test duration
EC <sub>x</sub>	Concentration with <i>x</i> % level of effect compared to the control
EPPO	European and Mediterranean Plant Protection Organisation
ERC	ecotoxicologically relevant type of concentration
ETR	exposure toxicity ratio
EU	European Union
FOCUS	FORum for Co-ordination of pesticide fate models and their Use
F <sub>trr</sub>	fraction of metabolite formed (% total radioactive residues)
GAP	Good Agricultural Practices
GD	Guidance Document
GLP	Good Laboratory Practices
Guttation	Appearance of drops of xylem sap on the tips or edges of leaves of some vascular Plants
HQ	hazard quotient, i.e. the quotient of the application rate and the acute oral or contact toxicity
Heubach-AI	The Heubach-Active Ingredient is a measure of dustiness of treated seeds based on abraded active ingredient
ICPBR	International Commission Plant Bee Relationship
IGR	insect growth regulator, group of compounds that affect the ability of insects to grow and mature normally
LC <sub>50</sub>	dose required to kill half the members of a tested population after a specified test duration

LOD	level of detection
LOQ	level of quantification
M(met)	molar mass metabolite
M <sub>acc</sub>	acceptable mortality
NOAEC	no observed adverse effect concentration
NOAEL	no observed adverse effect level
NOEC	no observed effect concentration
NOEL	no observed effect level
OECD	Organisation for Economic Co-operation and Development
PEC	predicted exposure concentration
PPP	plant protection product
PUF	plant uptake factor
RAC	regulatory acceptable concentration
RUD	residue unit dose
SCFoCAH	Standing Committee on Food Chain and Animal Health
SPG	specific protection goal
SUW	Sideward and upward spray, it includes all applications where the spray is directed sideways or upwards (this can be air assisted or without air assistance).
TSCF	transpiration stream concentration factor
TU	toxic unit

## REFERENCES

- Alix A and Lewis G, 2010. Guidance for the assessment of risks to bees from the use of plant protection products under the framework of Council Directive 91/414 and Regulation 1107/2009. *EPPO Bulletin*, 40, 196-203.
- Arena M and Sgolastra F, 2013. A meta-analysis comparing the sensitivity of bees to pesticides. In prep.
- Balderrama NM, Nunez JA and Almeida DLO, 1992. Metabolic-Rate during Foraging in the Honeybee. *Journal of Comparative Physiology B-Biochemical Systemic and Environmental Physiology*, 162, 440-447.
- BBA 2000. Bekanntmachung über die Abtrifteckwerte, die bei der Prüfung und Zulassung von Pflanzenschutzmitteln herangezogen werden. *Bundesanzeiger No.100, amtlicher Teil, vom 25. Mai 2000, S. 9879.*
- Becher MA, Hildenbrandt H, Hemelrijk CK and Moritz RFA, 2010. Brood temperature, task division and colony survival in honeybees: A model. *Ecological Modelling*, 221, 769-776.
- Biesmeijer JC, Roberts SP, Reemer M, Ohlemuller R, Edwards M, Peeters T, Schaffers AP, Potts SG, Kleukers R, Thomas CD, Settele J and Kunin WE, 2006. Parallel declines in pollinators and insect-pollinated plants in Britain and the Netherlands. *Science*, 313, 351-354.
- Boesten JJTI, Kopp H, Adriaanse PI, Brock TCM and Forbes VE, 2007. Conceptual model for improving the link between exposure and effects in the aquatic risk assessment of pesticides. *Ecotoxicology and Environmental Safety*, 66, 291-308.
- Bosch J and Kemp WP, 2002. Developing and establishing bee species as crop pollinators: the example of *Osmia* spp. (Hymenoptera: Megachilidae) and fruit trees. *Bulletin of Entomological Research*, 92, 3-16.
- Bosch J, 2008. Production of undersized offspring in a solitary bee. *Animal Behaviour*, 75, 809-816.
- Bosch J, Sgolastra F and Kemp WP, 2008. Life Cycle Ecophysiology of *Osmia* Mason Bees Used as Crop Pollinators. In: *Bee Pollination in Agricultural Ecosystems*. Oxford University Press, Oxford, UK.
- Butler CG, 1944. The influence of various physical and biological factors of the environment on honeybee activity. An examination of the relationship between activity and nectar concentration and abundance. *Journal of Experimental Biology*, 21, 5-21.
- Candolfi MP, Barrett KL, Campbell PJ, Forster R, Grandy N, Huet MC, Lewis G, Oomen PA, Schmuck R and Vogt H, 2001. Guidance document on regulatory testing and risk assessment procedures for plant protection products with non-target arthropods. *Proceedings from the ESCORT 2 workshop. Proceedings of the SETAC, Pensacola*, 46.
- CEB (Commission des Essais Biologiques), 2012. Méthode d'évaluation des effets de toxicité aiguë et a court terme des préparations phytopharmaceutiques sur l'abeille domestique (*Apis mellifera* L.). AFPP method n°230.
- Committee on the Status of Pollinators in North America NRC, 2007. *Status of pollinators in North America*. National Academies Press.
- Contessi A, 2005. *Le api*. Edagricole, Bologna, Italy.
- Corbet SA, 2003. Nectar sugar content: estimating standing crop and secretion rate in the field. *Apidologie*, 34, 1-10.
- Costa C, Buchler R, Berg S, Bienkowska M, Bouga M, Bubalo D, Charistos L, Le Conte Y, Drazic M, Dyrba W, Fillipi J, Hatjina F, Ivanova E, Kezic N, Kiprijanovska H, Kokinis M, Korpela S, Kryger P, Lodesani M, Meixner M, Panasiuk B, Pechhacker H, Petrov P, Oliveri E, Ruottinen L, Uzunov

- A, Vaccari G and Wilde J, 2012. A Europe-Wide Experiment for Assessing the Impact of Genotype-Environment Interactions on the Vitality and Performance of Honey Bee Colonies: Experimental Design and Trait Evaluation. *Journal of Apicultural Science*, 56, 147-158.
- Cresswell JE and Thompson HM, 2012. Comment on "A Common Pesticide Decreases Foraging Success and Survival in Honey Bees". *Science*, 337.
- Ctgb (Board for the Authorisation of Plant Protection Products and Biocides), 2011. Definitielijst toepassingsgebieden gewasbeschermingsmiddelen' (DTG lijst, versie 2.0).
- da Silva-Matos EV and Garofalo CA, 2000. Worker life tables, survivorship, and longevity in colonies of *Bombus (Fervidobombus) atratus* (Hymenoptera: Apidae). *Revista De Biologia Tropical*, 48, 657-663.
- Decourtye A, Devillers J, Genecque E, Le Menach K, Budzinski H, Cluzeau S and Pham-Delegue MH, 2005. Comparative sublethal toxicity of nine pesticides on olfactory learning performances of the honeybee *Apis mellifera*. *Archives of Environmental Contamination and Toxicology*, 48, 242-250.
- DG Agriculture 1997. General recommendations for the design, preparation and realization of residue trials. Report 7029/VI/95-rev.5., 72 pp.
- DG SANCO 2009. Guidelines relating to setting Maximum Residue Levels in honey. Report SANCO 11105/2009-rev.0. 36 pp.
- DG SANCO 2011. Guidelines on comparability, extrapolation, group tolerances and data requirements for setting MRLs. Report SANCO 7525/VI/95-rev.9., 46 pp.
- Dimitrov S, Dimitrova G, Pavlov T, Dimitrova N, Patlewicz G, Niemela J and Mekenyan O, 2005. A stepwise approach for defining the applicability domain of SAR and QSAR models. *Journal of Chemical Information and Modeling*, 45, 839-849.
- Dukas R, 2008. Mortality rates of honey bees in the wild. *Insectes Sociaux*, 55, 252-255.
- EC (European Commission), 2002a. European commission. Guidance Document on Risk Assessment for Birds and Mammals under Council Directive 91/414/EEC. SANCO/4145/2000 – final 25 September 2002. 74 pp.
- EC (European Commission), 2002b. SANCO/10329/2002 rev 2 Draft Working Document Guidance Document on Terrestrial Ecotoxicology Under Council Directive 91/414/EEC.
- EC (European Commission), 2005. Guidance Document on the assessment of the equivalence of technical materials of substances regulated under council directive 91/414 EEC. Sanco/10597/2003 –rev. 7 final2.
- EC (European Commission), 2012. SANCO/10553/2012 rev. 0, 8 March 2012, Guidance Document on the authorisation of Plant Protection Products for seed treatment
- EFSA (European Food Safety Authority), 2004. Scientific Opinion of the Panel on Plant health, Plant protection products and their Residues on a request from EFSA on the appropriateness of using the current FOCUS surface water scenarios for estimating exposure for risk assessment in aquatic ecotoxicology in the context of Council Directive 91/414/EEC. *The EFSA Journal* 2004, 145, 1-131.
- EFSA (European Food Safety Authority), 2005. Scientific Opinion of the Panel on Plant Health, Plant Protection Products and their Residues (PPR) on a request from EFSA related to the evaluation of pirimicarb. *The EFSA Journal* 2005, 240, 1 -21.
- EFSA (European Food Safety Authority), 2007a. Scientific Opinion of the Panel on Plant protection products and their Residues on a request from the European Commission on the risks associated with an increase of the MRL for dieldrin on courgettes. *The EFSA Journal* 2007, 554, 1-48.

- EFSA (European Food Safety Authority), 2007b. Scientific Opinion of the Panel on Plant protection products and their Residues on a request from the European Commission on acute dietary intake assessment of pesticide residues in fruit and vegetables. The EFSA Journal 2007, 538, 1-88.
- EFSA (European Food Safety Authority), 2008a. Scientific Opinion of the Panel on Plant Protection products and their Residues on a request from EFSA to evaluate the suitability of existing methodologies and, if appropriate, the identification of new approaches to assess cumulative and synergistic risks from pesticides to human health with a view to set MRLs for those pesticides in the frame of Regulation (EC) 396/2005. The EFSA Journal 2008 704, 1-3.
- EFSA (European Food Safety Authority), 2008b. Revision of Guidance Document under Council Directive 91/414/EEC (SANCO/4145/2000 – final of 25 September 2002). Scientific Opinion of the Panel on Plant protection products and their Residues (PPR) on a request from EFSA on the Science behind the Guidance Document on Risk Assessment for birds and mammals. The EFSA Journal 2008, 734, 1-181.
- EFSA (European Food Safety Authority), 2009. Guidance of EFSA: Risk assessment for birds and mammals. The EFSA Journal 2009;7(12):1438 [1358 pp.] doi:10.2903/j.efsa.2009.1438.
- EFSA (European Food Safety Authority), 2012. Statement on the findings in recent studies investigating sub-lethal effects in bees of some neonicotinoids in consideration of the uses currently authorised in Europe. The EFSA Journal 2012;10(6):2752 [27 pp.] doi:10.2903/j.efsa.2012.2752.
- EFSA Panel on Plant Protection Products and their Residues (PPR) 2010. Scientific Opinion of the Panel on Plant Protection Products and their Residues on a request from EFSA on the development of specific protection goal options for environmental risk assessment of pesticides, in particular in relation to the revision of the Guidance Documents on Aquatic and Terrestrial Ecotoxicology (SANCO/3268/2001 and SANCO/10329/2002). The EFSA Journal 2010;8(10):1821 [55 pp.] doi:10.2903/j.efsa.2010.1821.
- EFSA Panel on Plant Protection Products and their Residues (PPR) 2012a. Scientific Opinion of the Panel on Plant Protection Products and their Residues on a request from the European Commission on the science behind the development of a risk assessment of plant protection products on bees (*Apis mellifera*, *Bombus* spp. and solitary bees). The EFSA Journal 2012;10(5):2668 [275 pp.]. doi:10.2903/j.efsa.2012.2668.
- EFSA Panel on Plant Protection Products and their Residues (PPR) 2012b. Scientific Opinion of the Panel on Plant Protection Products and their Residues on a request from EFSA on the science behind the guidance for scenario selection and scenario parameterisation for predicting environmental concentrations of plant protection products in soil. The EFSA Journal 2012;10(5): 2562 [76 pp.] doi:10.2903/j.efsa.2012.2562.
- European Food Safety Authority, 2014. EFSA Guidance Document for evaluating laboratory and field dissipation studies to obtain DegT50 values of active substances of plant protection products and transformation products of these active substances in soil. EFSA Journal 2014;12(5):3662, 268 pp., doi:10.2903/j.efsa.2014.3662
- EPPO (European and Mediterranean Plant Protection Organization), 2003. Environmental risk assessment scheme for plant protection products. Chapter 10: Honeybees. EPPO Bulletin, 33, 141-145.
- EPPO (European and Mediterranean Plant Protection Organization), 2010. PP 1/170 (4): Side-effects on honeybees. 40, 313-319.
- FAOSTAT (Food and Agriculture Organization) 2010. Statistical Database. Available at <http://faostat.fao.org>; Agricultural data/Agricultural production/Crops primary.
- FLORAPIS (2012). Data available at: <http://www.florapis.org/>

- FOCUS (Forum for the Co-ordination of Pesticide Fate Models and their Use), 2001. FOCUS Surface Water Scenarios in the EU Evaluation Process under 91/414/EEC. Report of the FOCUS Working Group on Surface Water Scenarios, EC Document Reference SANCO/4802/2001-rev.2. 245 pp.
- FOCUS (Forum for the Co-ordination of Pesticide Fate Models and their Use), 2006. "Guidance Document on Estimating Persistence and Degradation Kinetics from Environmental Fate Studies on Pesticides in EU Registration" Report of the FOCUS Work Group on Degradation Kinetics, EC Document Reference SANCO /10058/2005 version 2.0, 434 pp.
- FOCUS (Forum for the Co-ordination of Pesticide Fate Models and their Use), 2007a. Landscape And Mitigation Factors In Aquatic Risk Assessment. Volume 2. Detailed Technical Reviews. Report of the FOCUS Working Group on Landscape and Mitigation Factors in Ecological Risk Assessment, EC Document Reference, SANCO/10422/2005 v2.0. 436 pp.
- FOCUS (Forum for the Co-ordination of Pesticide Fate Models and their Use), 2007b. Landscape and mitigation factors in aquatic risk assessment. Volume 1. Extended Summary and Recommendations". Report of the FOCUS Working Group on Landscape and Mitigation Factors in Ecological Risk Assessment, EC Document Reference SANCO/10422/2005 v2.0. 169 pp.
- FOCUS (Forum for the Co-ordination of Pesticide Fate Models and their Use), 2009. Assessing Potential for Movement of Active Substances and their Metabolites to Ground Water in the EU. Report of the FOCUS Ground Water Work Group, EC Document Reference Sanco/13144/2010 version 1. 604 pp.
- Free JB and Spencer-Booth Y, 1958. Observations on the temperature regulation and food consumption of honeybees (*Apis mellifera*). *Journal of Experimental Biology*, 35, 930-937.
- Free JB, 1970. *Insect pollination of crops*. Academic Press, London, UK.
- Gallai N, Salles JM, Settele J and Vaissiere BE, 2009. Economic valuation of the vulnerability of world agriculture confronted with pollinator decline. *Ecological Economics*, 68, 810-821.
- Georgiadis PT, Pistorius J, Heimbach U, Stahler M and Schwabe K, 2012. Dust drift during sowing of maize-effects on honey bees. *Julius-Kuhn-Archiv*, 437, 134-139.
- Gill RJ, Ramos-Rodriguez O and Raine NE, 2012. Combined pesticide exposure severely affects individual- and colony-level traits in bees. *Nature*, 491, 105-U119.
- Girolami V, Marzaro M, Vivian L, Mazzon L, Giorio C, Marton D and Tapparo A, 2013. Aerial powdering of bees inside mobile cages and the extent of neonicotinoid cloud surrounding corn drillers. *Journal of Applied Entomology*, 137, 35-44.
- Gregorc A and Bowen ID, 1999. In situ localization of heat-shock and histone proteins in honey-bee (*Apis mellifera* L.) larvae infected with *Paenibacillus* larvae. *Cell Biology International*, 23, 211-218.
- Hatjina F, Papaefthimiou CL, Dogaroglu T, Bouga M, Emmanoui IC and Arnold G, 2013. Sublethal doses of imidacloprid decreased size of hypopharyngeal glands and respiratory rhythm of honey bees in vivo. *Apidologie*, 44, 467-480.
- Haydak HM, 1943. Larval food and development of castes in the honeybee. *Journal of Economic Entomology*, 36, 778-792.
- Henry M, Beguin M, Requier F, Rollin O, Odoux JF, Aupinel P, Aptel J, Tchamitchian S and Decourtye A, 2012a. A Common Pesticide Decreases Foraging Success and Survival in Honey Bees. *Science*, 336, 348-350.
- Henry M, Beguin M, Requier F, Rollin O, Odoux JF, Aupinel P, Aptel J, Tchamitchian S and Decourtye A, 2012b. Response to Comment on "A Common Pesticide Decreases Foraging Success and Survival in Honey Bees". *Science*, 337.

- Himmer A, 1927. Ein Beitrag zur Kenntnis des Wärmehaushaltes im Nestbau sozialer Hautflügler Z Vgl Physiol, 5, 375-379.
- Huijsmans JFM and van de Zande JV, 2011. Workshop harmonisation of drift and drift reducing technologies for evaluation and authorization of plant protection products. Report 390 Plant Research International. Proceedings of the Acta Agriculturae Zhejiangensis, Wageningen, 1-2 December 2010.
- Hull RN and Swanson S, 2006. Sequential analysis of lines of evidence – an advanced weight of evidence approach for ecological risk assessment. Integrated environmental assessment and management, 2, 302-311.
- Imdorf A, Buehlmann G, Gerig L, Kilchenmann V and Wille H, 1987. A Test of the Method of Estimation of Brood Areas and Number of Worker Bees in Free-Flying Colonies. Apidologie, 18, 137-146.
- Jaworska J, Nikolova-Jelizkova, N., Aldenberg, T., , 2005. Review of methods for QSAR applicability domain estimation by the training set. Alternatives to Laboratory Animals, 33, 445-459.
- Karise R, Viik E and Maend M, 2007. Impact of alpha-cypermethrin on honey bees foraging on spring oilseed rape (*Brassica napus*) flowers in field conditions(+). Pest Management Science, 63, 1085-1089.
- Keeler KH 2008. World list of angiosperms with extrafloral nectaries. Available online: <http://biosci-labs.unl.edu/Emeriti/keeler/extrafloral/Cover.htm>.
- Kevan PG and Baker HG, 1983. Insects as Flower Visitors and Pollinators. Annual Review of Entomology, 28, 407-453.
- Khoury DS, Myerscough MR and Barron AB, 2011. A Quantitative Model of Honey Bee Colony Population Dynamics. PloS one, 6, e18491.
- Klein AM, Vaissiere BE, Cane JH, Steffan-Dewenter I, Cunningham SA, Kremen C and Tscharntke T, 2007. Importance of pollinators in changing landscapes for world crops. Proceedings of the Proceedings of the Royal Society of London Series B, 274, 303-313.
- Koch H and Weisser P, 1997. Exposure of honey bees during pesticide application under field conditions. Apidologie, 28, 439-447.
- Kortenkamp A, Backhaus T and Faust M 2009. State of the Art on Mixture Toxicity.
- Kronenberg F and Heller HC, 1982. Colonial Thermoregulation in Honey Bees (*Apis-Mellifera*). Journal of Comparative Physiology, 148, 65-76.
- Kronic MD and Stanisavljevic L.Z. 2006. The biology of European Orchard Bee *Osmia cornuta*.
- Ladas A, 1972. Der Einfluss Verschiedener Konstitutions- Und Umweltfaktoren auf die Anfalligkeit der Honigbiene (*Apis mellifica* L.) gegenüber zwei Insektiziden Pflanzenschutzmitteln. Apidologie, 3, 55-78.
- Ladurner E, Bosch J, Kemp WP and Maini S, 2008. Foraging and nesting behavior of *Osmia lignaria* (Hymenoptera: megachilidae) in the presence of fungicides: Cage studies. Journal of Economic Entomology, 101, 647-653.
- Ladurner E, Bosch J, Maini S and Kemp WP, 2003. A method to feed individual bees (Hymenoptera : Apiformes) known amounts of pesticides. Apidologie, 34, 597-602.
- Laycock I, Lenthall KM, Barratt AT and Cresswell JE, 2012. Effects of imidacloprid, a neonicotinoid pesticide, on reproduction in worker bumble bees (*Bombus terrestris*). Ecotoxicology, 21, 1937-1945.
- Leistra M and Dekkers WA, 1977. Computed Effects of Adsorption-Kinetics on Pesticide Movement in Soils. Journal of Soil Science, 28, 340-350.

- Luttik R, Hart, A, Roelofs, W, Craig, P, Mineau, P, 2011. Variation in the level of protection afforded to birds and crustaceans exposed to different pesticides under standard risk assessment procedures. *Integrated environmental assessment and management*, 7, 459–465.
- Maccagnani B, Ladurner E, Santi F and Burgio G, 2003. *Osmia cornuta* (Hymenoptera, Megachilidae) as a pollinator of pear (*Pyrus communis*): fruit- and seed-set. *Apidologie*, 34, 207-216.
- Madelin R 2004. The importance of scientific advice in the Community decision making process. Opening address to the Inaugural Joint Meeting of the members of the Non-Food Scientific Committees. Directorate General for Health and Consumer Protection, European Commission, Brussels.
- Marletto F, Patetta A and Manino A, 2003. Laboratory assessment of pesticide toxicity to bumble bees. *Bulletin of Insectology*, 56, 155-158.
- McGregor SE, 1976. Insect pollination of cultivated crop plants. Agricultural Handbook No. 496. Ed USDA Agricultural Research Service W, D.C, USA.
- Meixner M, D., Pinto MA, Bouga M, Kryger P, Ivanova E and Fuchs S, 2013. Standard methods for characterising subspecies and ecotypes of *Apis mellifera*. *Environmental Toxicology and Chemistry*. In V Dietemann; J D Ellis; P Neumann
- Meled M, Thrasyvoulou A and Belzunces LP, 1998. Seasonal variations in susceptibility of *Apis mellifera* to the synergistic action of prochloraz and deltamethrin. *Environmental Toxicology and Chemistry*, 17, 2517-2520.
- Mineau P, Harding KM, Whiteside M, Fletcher MR, Garthwaite D and Knopper LD, 2008. Using reports of bee mortality in the field to calibrate laboratory-derived pesticide risk indices. *Environmental Entomology*, 37, 546-554.
- Mommaerts V, Reynders S, Boulet J, Besard L, Sterk G and Smagghe G, 2010. Risk assessment for side-effects of neonicotinoids against bumblebees with and without impairing foraging behavior. *Ecotoxicology*, 19, 207-215.
- Monzon VH, Bosch J and Retana J, 2004. Foraging behavior and pollinating effectiveness of *Osmia cornuta* (Hymenoptera: Megachilidae) and *Apis mellifera* (Hymenoptera: Apidae) on "Comice" pear. *Apidologie*, 35, 575-585.
- Netzeva TI, Worth, A., Aldenberg, T., Benigni, R., Cronin, M.T., Gramatica, P., Jaworska, J.S., Kahn, S., Klopman, G., Marchant, C.A., Myatt, G., Nikolova-Jeliazkova, N., Patlewicz, G.Y., Perkins, R., Roberts, D., Schultz, T., Stanton, D.W., van de Sandt, J.J., W Tong, Veith G and Yang C, 2005. Current Status of Methods for Defining the Applicability Domain of (Quantitative) Structure-Activity Relationships. The report and recommendations of ECVAM Workshop 52. *Alternatives to Laboratory Animals*, 33, 155-173.
- Nicolson SW and Human H, 2012. Chemical composition of the 'low quality' pollen of sunflower (*Helianthus annuus*, Asteraceae). *Apidologie*, 44, 144-152.
- Nicolson SW, 2009. Water homeostasis in bees, with the emphasis on sociality. *Journal of Experimental Biology*, 212, 429-434.
- Nikolova N and Jaworska J, 2005. Approaches to measure chemical similarity - A review. *Qsar & Combinatorial Science*, 24, 318-318.
- OECD (Organization for Economic Cooperation and Development), 2007. Guidance document on the honey bee (*Apis mellifera* L.) brood test under semi-field conditions. Series on Testing and Assessment, No. 75. 3-27.
- OECD (Organization for Economic Cooperation and Development), 2009. OECD guideline for the testing of chemicals 509: crop field trial. 44 pp.

- OECD (Organization for Economic Cooperation and Development), 2013. OECD guideline for the testing of chemicals 237: Honey bee (*Apis mellifera*) larval toxicity test, single exposure. 10 pp.
- OECD 213 (Organization for Economic Cooperation and Development), 1998. Guidance for the testing of chemicals. Honeybees Acute Oral Toxicity test. Test Guidelines 213.
- OECD 214 (Organization for Economic Cooperation and Development), 1998. Guidance for the testing of chemicals. Honeybees Acute Contact Toxicity Test. Test Guidelines 214.
- Olesen MH and Jensen PK 2013. External Scientific Report submitted to EFSA. Collection and evaluation of relevant information on crop interception. Question number: EFSA-Q-2011-00767.
- Peters DS, 1977. Systematik und Zoogeographie der west-paläarktischen Arten von *Osmia*'s str., *Monosmia*, und *Orientosmia*. *Senckenbergiana biologica* (Frankfurt a. M.), 58, 287-346.
- Průdal A and Hofbauer J 1996. Laboratory rearing and nutrition of young queens of Bumblebee (*Bombus terrestris* L.) from emergence to diapause. 14, 125-131.
- Reetz JE, Zuehlke S, Spiteller M and Wallner K, 2011. Neonicotinoid insecticides translocated in guttated droplets of seed-treated maize and wheat: a threat to honeybees? *Apidologie*, 42, 596-606.
- Ricciardelli d'Albore G and Intoppa F, 2000. Flora e Api - La flora visitata dalle api e dagli altri apoidei in Europa. Calderini Edagricole.
- Rueppell O, Bachelier C, Fondrk MK and Page RE, 2007. Regulation of life history determines lifespan of worker honey bees (*Apis mellifera* L.). *Experimental Gerontology*, 42, 1020-1032.
- Rueppell O, Kaftanoglu O and Page RE, 2009. Honey bee (*Apis mellifera*) workers live longer in small than in large colonies. *Experimental Gerontology*, 44, 447-452.
- Ruttner F, 1988. Biogeography and taxonomy of honey bees. Springer Verlag, Heidelberg, Berlin, New York.
- Sagili RR, Pankiw T and Zhu-Salzman K, 2005. Effects of soybean trypsin inhibitor on hypopharyngeal gland protein content, total midgut protease activity and survival of the honey bee (*Apis mellifera* L.). *Journal of Insect Physiology*, 51, 953-957.
- Sakagami SF and Fukuda H, 1968. Life tables for worker Honeybees. *Research on Population Ecology*, X, 127-139.
- Schippers MP, Dukas R, Smith RW, Wang J, Smolen K and McClelland GB, 2006. Lifetime performance in foraging honeybees: behaviour and physiology. *Journal of Experimental Biology*, 209, 3828-3836.
- Schmidhempel P and Heeb D, 1991. Worker mortality and colony development in bumblebees, *Bombus lucorum* (L.) (Hymenoptera, Apidae). *Bulletin de la société entomologique Suisse*, 64, 93-108.
- Schmidhempel P and Wolf T, 1988. Foraging Effort and Life-Span of Workers in a Social Insect. *Journal of Animal Ecology*, 57, 509-521.
- Seeley TD and Heinrich B, 1981. Regulation of temperature in the nests of social insects. New York, Toronto: John Wiley & Sons, Inc.
- Sgolastra F, Kemp WP, Maini S and Bosch J, 2012a. Duration of prepupal summer dormancy regulates synchronization of adult diapause with winter temperatures in bees of the genus *Osmia*. *Journal of Insect Physiology*, 58, 924-933.
- Sgolastra F, Renzi T, Draghetti S, Medrzycki P, Lodesani M, Maini S and Porrini C, 2012b. Effects of neonicotinoid dust from maize seed-dressing on honey bees. *Bulletin of Insectology*, 65, 273-280.
- Sinclair DG, 2009. Predicting the environmental fate and ecotoxicological and toxicological effects of pesticide transformation products. PhD, University of York,

- Skerl MIS and Gregorc A, 2010. Heat shock proteins and cell death in situ localisation in hypopharyngeal glands of honeybee (*Apis mellifera carnica*) workers after imidacloprid or coumaphos treatment. *Apidologie*, 41, 73-86.
- Snijders Tom AB, 2005. Power and Sample Size in Multilevel Linear Models. In: Everitt BS, Howell D (Eds.), 2005. *Encyclopedia of Statistics in Behavioral Science*. New York, Wiley.
- Somerville DC and Nicol HI, 2006. Crude protein and amino acid composition of honey bee-collected pollen pellets from south-east Australia and a note on laboratory disparity. *Australian Journal of Experimental Agriculture*, 46, 141-149.
- Stelzer RJ, Raine NE, Schmitt KD and Chittka L, 2010. Effects of aposematic coloration on predation risk in bumblebees? A comparison between differently coloured populations, with consideration of the ultraviolet. *Journal of Zoology*, 282, 75-83.
- Stirling A, 2010. Keep it complex. *Nature*, 468, 1029-1031.
- Suchail S, Guez D and Belzunces LP, 2000. Characteristics of imidacloprid toxicity in two *Apis mellifera* subspecies. *Environmental Toxicology and Chemistry*, 19, 1901-1905.
- Suchail S, Guez D and Belzunces LP, 2001. Discrepancy between acute and chronic toxicity induced by imidacloprid and its metabolites in *Apis mellifera*. *Environmental Toxicology and Chemistry*, 20, 2482-2486.
- Sur R, Gourlay V, Fent G, Schmitt W and Goerlitz G, 2012. Determination of plant uptake factors for pesticide fate modelling. *Proceedings of the SETAC conference, Berlin*.
- Szentes Cs, 2003. Miért nem mézél a napraforgó? II. *Méhészet*, 51, 14-15.
- Tapparo A, Giorio C, Marzaro M, Marton D, Solda L and Girolami V, 2011. Rapid analysis of neonicotinoid insecticides in guttation drops of corn seedlings obtained from coated seeds. *Journal of Environmental Monitoring*, 13, 1564-1568.
- Tasei JN and Aupinel P, 2008. Nutritive value of 15 single pollens and pollen mixes tested on larvae produced by bumblebee workers (*Bombus terrestris*, Hymenoptera : Apidae). *Apidologie*, 39, 397-409.
- Tasei JN, Sabik H, Piratsu L, Langiu E, Blanche JM, Fournier J and Taglioni JP, 1993. A sequential study on the effects of deltamethrin (Decis CE) on bumble bees. *Proceedings of the Proceedings of the 5th International Symposium Hazard of Pesticides to Bees, Wageningen, The Netherlands, October 1993*.
- Thompson H 2012. External Scientific Report . Interaction between pesticides and other factors in effects on bees. Project developed under the procurement project CT/EFSA/PRAS/2011/02.
- Thompson HM and Hunt LV, 1999. Extrapolating from honeybees to bumblebees in pesticide risk assessment. *Ecotoxicology*, 8, 147-166.
- Thompson HM and Thorbahn D, 2009. Review of honeybee pesticide poisoning incidents in Europe - evaluation of the hazard quotient approach for risk assessment. *Julius-Kuhn-Archiv*, 103-108.
- Thompson HM, 2001. Assessing the exposure and toxicity of pesticides to bumblebees (*Bombus* sp.). *Apidologie*, 32, 305-321.
- Thompson HM, 2010. Risk assessment for honey bees and pesticides - recent developments and 'new issues'. *Pest Management Science*, 66, 1157-1162.
- Torchio PF, 1973. Relative toxicity of insecticides to the honey bee, alkali bee, and alfalfa leafcutting bee (Hymenoptera: Apidae, Halictidae, Megachilidae). *Journal of the Kansas Entomological Society*, 46, 446-453.
- van der Steen JJM, 2001. Review of the methods to determine the hazard and toxicity of pesticides to bumblebees. *Apidologie*, 32, 399-406.

- Van der Steen JJM, Gretenkord C and Schaefer H, 1996. Method to determine the acute oral/contact LD50 of pesticides for bumblebees (*Bombus terrestris*). Proceedings of the 6th International Symposium on Hazard of Pesticides to Bees, Braunschweig, Germany, 17-19 September 1996.
- van der Zande JC, Holterman HJ and Huijsmans JFM 2012. Spray drift for assessment of exposure of aquatic organisms to plant protection products in the Netherlands. Report 419, 88.
- Verbruggen EMJ and van den Brink PJ 2010. Review of recent literature concerning mixture toxicity of pesticides to aquatic organisms. RIVM report 601400001. 34 pp.
- Verdonck FAM, Aldenberg T, Jaworska J and Vanrolleghew PA, 2003. Limitations of current risk characterization methods in probabilistic environmental risk assessment. *Environmental Toxicology and Chemistry*, 22, 2209-2213.
- Visscher PK and Dukas R, 1997. Survivorship of foraging honey bees. *Insectes Sociaux*, 44, 1-5.
- Whitehorn PR, O'Connor S, Wackers FL and Goulson D, 2012. Neonicotinoid Pesticide Reduces Bumble Bee Colony Growth and Queen Production. *Science*, 336, 351-352.
- WHO/FAO (World Health Organization/Food and Agriculture Organization), 2002. Manual on development and use of FAO and WHO specifications for pesticides. First edition, FAO Plant Production and Protection Paper 173.
- Winston ML, 1987. *The biology of the honey bee*. Harvard University Press, Cambridge, MA.
- Wykes GR, 1953. The sugar content of nectars. *Biochemical Journal*, 53, 294-296.
- Zajác E, 2011. Nectar production and some site-related issues of sunflower hybrids under different agro-ecological conditions. Szent Istvan University.